



Water Heater

Thermo Top Evo Parking Heater



With FuelFix

Installation Documentation Audi Q3

Validity

Manufacturer	Model	Type	EG-BE No. / ABE
Audi	Q3	8U	e1 * 2007 / 46 * 0591 * ...

Motorisation	Fuel	Transmission type	Output in kW	Displacement in cm ³	Engine code
1.4 TFSI	Petrol	SG	110	1395	CHPB
1.4 TFSI	Petrol	S-tronic	110	1395	CZEA
2.0 TFSI	Petrol / quattro	SG / S-tronic	125	1984	CCZC
2.0 TFSI	Petrol / quattro	S-tronic	155	1984	CPSA
2.0 TDI	Diesel	SG	103	1968	CFFB
2.0 TDI	Diesel / quattro	SG	103	1968	CFFB
2.0 TDI	Diesel / quattro	SG / S-tronic	120	1968	CFGD
2.0 TDI	Diesel / quattro	S-tronic	130	1968	CFGC
2.0 TDI	Diesel / quattro	S-tronic	135	1968	CUWA

SG = manual transmission

S-tronic = dual clutch transmission

From model year 2011

Left-hand drive vehicle

Verified equipment variants: Automatic air-conditioning
 Front fog lights
 Xenon
 Headlight washer system
 Start - Stop

Not verified: Manual air-conditioning
 Passenger compartment monitoring

Total installation time: approx. 6 hours

Audi Q3

Table of Contents

Validity	1	Preparing Heater	16
Necessary Components	2	Installing Heater	17
Installation Overview	2	Coolant Circuit Diagrams	18
Information on Total Installation Time	2	2.0 TFSI 125/155 KW	18
Information on Operating and Installation Instructions	3	1.4 TFSI 110 KW/ 2.0TDI 103/120/130 KW	19
Information on Validity	4	2.0 TDI 135 KW	20
Technical Information	4	Coolant Circuit	21
Explanatory Notes on Document	4	Combustion Air	30
Preliminary Work	5	Fuel	31
Heater Installation Location	5	Installing FuelFix	34
Electrical System	8	Exhaust Gas	40
Wiring Harness Routing	9	Final Work	43
Fan Controller	10	FuelFix Template	44
MultiControl CAR Option	12	Operating Instructions for Automatic A/C up to MY 2014	45
Telestart/ThermoCall Option	12	Operating Instructions for Automatic A/C from MY 2015	46
Preparing Installation Location	14		

Necessary Components

- Basic delivery scope of Thermo Top Evo based on price list
- Installation kit for FuelFix Audi Q3 2011 Petrol and diesel: **1318116C**
- Heater control in accordance with price list and upon consultation with end customer
- In case of Telestart, indicator lamp in accordance with price list and in consultation with end customer

Installation instructions:

- Arrange for the vehicle to be delivered with the tank only about $\frac{1}{4}$ full.
- The installation location of the push button in case of Telestart or Thermo Call should be confirmed with the end customer.
- Depending on the space required and the vehicle manufacturer's instructions, we recommend the use of a vehicle battery with a higher electrical capacity.

Installation Overview

Legend:

1. Heater
2. Engine compartment fuse holder
3. Passenger compartment relay and fuse holder
4. Circulating pump
5. MultiControl CAR
6. Metering pump
7. FuelFix

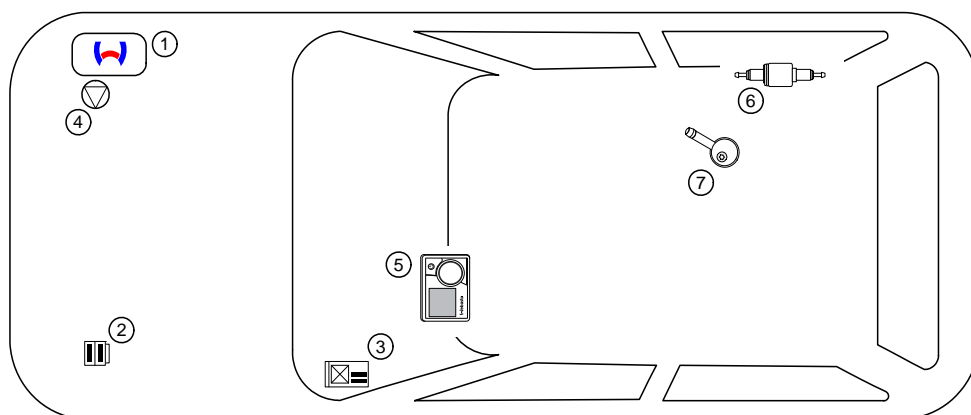

Information on Total Installation Time

The total installation time includes the time needed for mounting and demounting the vehicle-specific components, the heater specific installation time and all other times required for the system integration and initial start-up of the heater. The total installation time may vary for vehicle equipment other than provided.

Information on Operating and Installation Instructions

1 Important information (not complete)

1.1 Installation and repair



The improper installation or repair of Webasto heating and cooling systems can cause fire or the leakage of deadly carbon monoxide, leading to serious injury or death.



To install and repair Webasto heating and cooling systems you need to have completed a special company training course and have the appropriate technical documentation, special tools and special equipment.



Installation and repair may ONLY be carried out by persons trained and certified in a Webasto training course. NEVER try to install or repair Webasto heating or cooling systems if you have not completed a Webasto training course, you do not have the necessary technical skills and you do not have the technical documentation, tools and equipment available to ensure that you can complete the installation and repair work properly.

Only use genuine Webasto parts. See the Webasto air and water heaters accessories catalogue for this purpose.

1.2 Operation

To ensure safe operation, we recommend having the heater checked every two years by an authorised Webasto dealer, especially when used over a long period and/or under extreme environmental conditions.

Do not operate the heater in closed rooms due to the danger of poisoning and suffocation.

Always switch off the heater before refuelling.

The heater may only be used with the prescribed fuel diesel (DIN EN 590) or petrol (DIN EN 228).

The heater may not be cleaned with a high-pressure cleaner.

1.3 Please note

ALWAYS follow all Webasto installation and operating instructions and observe all warnings.

To become familiar with and understand all functions and properties of the heater, the operating instructions must be read carefully and observed at all times.

For proper, safe installation and repair work, the installation instructions with all warnings and safety information must be carefully read and observed at all times. Please always contact a workshop authorised by Webasto for all installation and repair work.

Important

Webasto shall assume no liability for defects, damage and injuries resulting from a failure to observe the installation, repair and operating instructions of the information contained in them.

This liability exclusion particularly applies to improper installations and repairs, installations and repairs by untrained persons or in the case of a failure to use genuine spare parts.

The liability due to culpable disregard to life, limb or health and due to damage or injuries caused by a wilful or reckless breach of duty remain unaffected, as does the obligatory product liability.

Installation should be carried out according to the general, standard rules of technology. Unless specified otherwise, fasten hoses, lines and wiring harnesses to original vehicle lines and wiring harnesses using cable ties. Insulate loose wire ends and tie back. Connectors on electronic components must audibly click into place during installation.

Sharp edges should be fitted with rub protection. Spray unfinished body areas, e.g. drilled holes, with anti-corrosion wax (Tectyl 100K).

Observe the instructions and guidelines of the respective vehicle manufacturer for demounting and mounting vehicle specific components!

The initial startup is to be executed with the Webasto Thermo Test Diagnosis.

When installing a programmable control module (e.g. a PWM Gateway), the corresponding settings must be checked or adjusted.

2 Statutory regulations governing installation

Guidelines	Thermo Top Evo
Heating Directive ECE R122	E1 00 0258
EMC Directive ECE R10	E1 04 5627

Note

The regulations of these guidelines are binding in the scope of the Directive 70/156/EEC and/or 2007/46/EC (for new vehicle models from 29/04/2009) and should also be observed in countries in which there are no special regulations.

Important

Failure to follow the installation instructions will result in the invalidation of the type approval for the heater and therefore invalidation of the general **homologation of the vehicle**.

Note

The heater is licensed in accordance with paragraph 19, section 3, No. 2b of the StVZO (German Road Traffic Licensing Authority).

2.1 Excerpt from ECE regulation 122 (heating system) paragraph 5 for the installation of the heater

Beginning of excerpt.

ANNEX VII

REQUIREMENTS FOR COMBUSTION HEATERS AND THEIR INSTALLATION

1. GENERAL REQUIREMENTS

1.7.1. A clearly visible tell-tale in the operator's field of view shall inform when the combustion heater is switched on or off.

2. VEHICLE INSTALLATION REQUIREMENTS

2.1. Scope

2.1.1. Subject to paragraph 2.1.2, combustion heaters shall be installed according to the requirements of this Annex.

2.1.2. Vehicles of category O having liquid fuel heaters are deemed to comply with the requirements of this Annex.

2.2. Positioning of heater

2.2.1. Body sections and any other components in the vicinity of the heater must be protected from excessive heat and the possibility of fuel or oil contamination.

2.2.2. The combustion heater shall not constitute a risk of fire, even in the case of overheating. This requirement shall be deemed to be fulfilled if the installation ensures an adequate distance to all parts and suitable ventilation, by the use of fire resistant materials or by the use of heat shields.

2.2.3. In the case of M2 and M3 vehicles, the heater must not be positioned in the passenger compartment. However, an installation in an effectively sealed envelope which also complies with the conditions in paragraph 2.2.2 may be used.

2.2.4. The label referred to in paragraph 1.4 or a duplicate, must be positioned so that it can be easily read when the heater is installed in the vehicle.

2.2.5. Every reasonable precaution should be taken in positioning the heater to minimise the risk of injury and damage to personal property.

2.3. Fuel supply

2.3.1. The fuel filler must not be situated in the passenger compartment and must be provided with an effective cap to prevent fuel spillage.

2.3.2. In the case of liquid fuel heaters, where a supply separate to that of the vehicle is provided, the type of fuel and its filler point must be clearly labelled.

2.3.3. A notice, indicating that the heater must be shut down before refuelling, must be affixed to the fuelling point. In addition a suitable instruction must be included in the manufacturer's operating manual.

2.4. Exhaust system

2.4.1. The exhaust outlet must be located so as to prevent emissions from entering the vehicle through ventilators, heated air inlets or opening windows.

2.5. Combustion air inlet

2.5.1. The air for the combustion chamber of the heater must not be drawn from the passenger compartment of the vehicle.

2.5.2. The air inlet must be so positioned or guarded that blocking by rubbish or luggage is unlikely.

2.6. Heating air inlet

2.6.1. The heating air supply may be fresh or recirculated air and must be drawn from a clean area not likely to be contaminated by exhaust fumes emitted either by the propulsion engine, the combustion heater or any other vehicle source.

2.6.2. The inlet duct must be protected by mesh or other suitable means.

2.7. Heating air outlet

2.7.1. Any ducting used to route the hot air through the vehicle must be so positioned or protected that no injury or damage could be caused if it were to be touched.

2.7.2. The air outlet must be so positioned or guarded that blocking by rubbish or luggage is unlikely.

End of excerpt.

In multilingual versions the German language is binding.

Audi Q3

Information on Validity

This installation documentation applies to Audi Q3 Petrol and diesel vehicles - for validity, see page 1 - from model year 2011 and later, assuming technical modifications to the vehicle do not affect installation, any liability claims excluded. Depending on the vehicle version and equipment, modifications may be necessary during installation with respect to this 'installation documentation'.

Vehicle and engine types, equipment variants and other specifications not listed in this installation documentation have not been tested. However, installation according to this installation documentation may be possible.

Technical Information

Special Tools

- Hose clamp pliers for auto-tightening hose clamps
- Hose clamp pliers for Clic hose clamps of type W
- Automatic wire stripper 0.2 - 6mm²
- Crimping pliers for cable lug / tab connector 0.5 - 6mm²
- Torque wrench for 2.0 - 10 Nm
- Hose clamping pliers
- Metric thread-setter kit
- Deep-hole marker
- Webasto Thermo Test diagnosis with current software

Dimensions

- All dimensions are in mm.

Tightening torque values

- Tightening torque values of 5x13 heater bolts and 5x11 heater stud bolts = 8Nm.
- Tightening torque value of 5x15 water connection piece retaining plate bolt = 7Nm.
- Tighten other bolt connections in accordance with manufacturer's instructions or in accordance with state-of-the-art technology.

Explanatory Notes on Document

You will find an identification mark on the outside top right corner of the page in question to provide you with a quick overview of the individual working steps.

Special features are highlighted using the following symbols:

Mechanical System



Electrical System



Coolant Circuit



Combustion Air

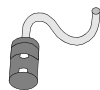

Fuel



Exhaust Gas



Software



Specific risk of damage to components.



Specific risk due to electrical voltage.



Specific risk of injury or fatal accidents.



Specific risk of fire or explosion.



Reference to the manufacturer's vehicle-specific documents or to the general installation instructions of Webasto components.



Reference to a special technical feature.



The arrow in the vehicle icon indicates the position on the vehicle and the viewing angle.

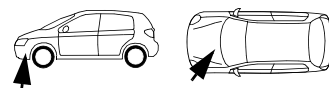

Tightening torque according to the manufacturer's vehicle-specific documents.



Preliminary Work

Vehicle



- Open the fuel tank cap.
- Ventilate the fuel tank.
- Close the fuel tank cap again.
- Depressurise the cooling system.
- Remove the engine cover.
- Disconnect and remove the battery.
- Remove the battery carrier.
- Remove the air filter together with the intake hose (if petrol engine).
- Disengage the diesel filter (if diesel engine).
- Remove the front underide protection.
- Remove the right front wheel.
- Remove the right-hand wheel well trim.
- Remove the right-hand underide protection.
- Remove the right-hand horn.
- Remove the right rear bench seat.
- Open the right-hand tank-fitting service lid.
- Remove the footwell trim on the driver's and front passenger's sides.

Heater

- Remove years that do not apply from the type and duplicate label.
- Attach the duplicate label (type label) visibly in the appropriate place in the engine compartment.

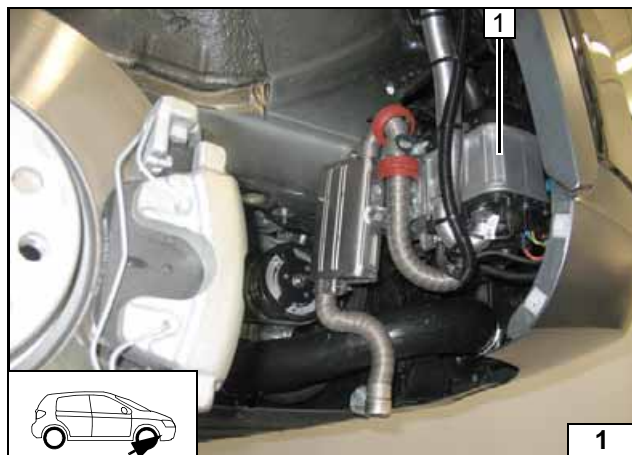

Heater Installation Location

- 1 Heater

Installation
Location

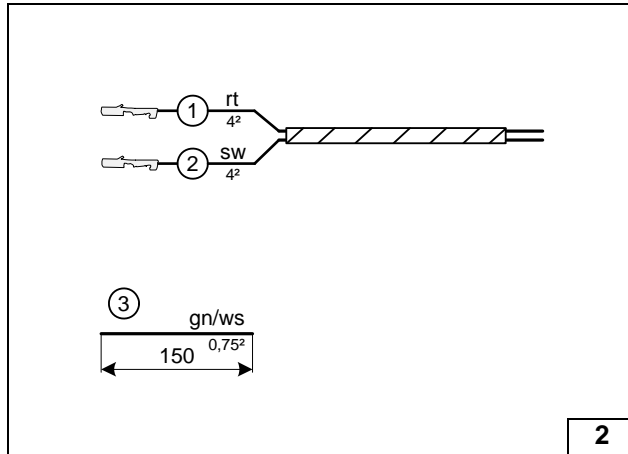
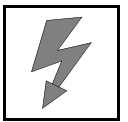

Preparing Electrical System

Wire sections retain their numbering in the entire document.

Produce all following electrical connections as shown in the wiring diagram.

- ① Red (rt) wire of fan wiring harness
- ② Black (sw) wire of fan wiring harness



Assigning wires

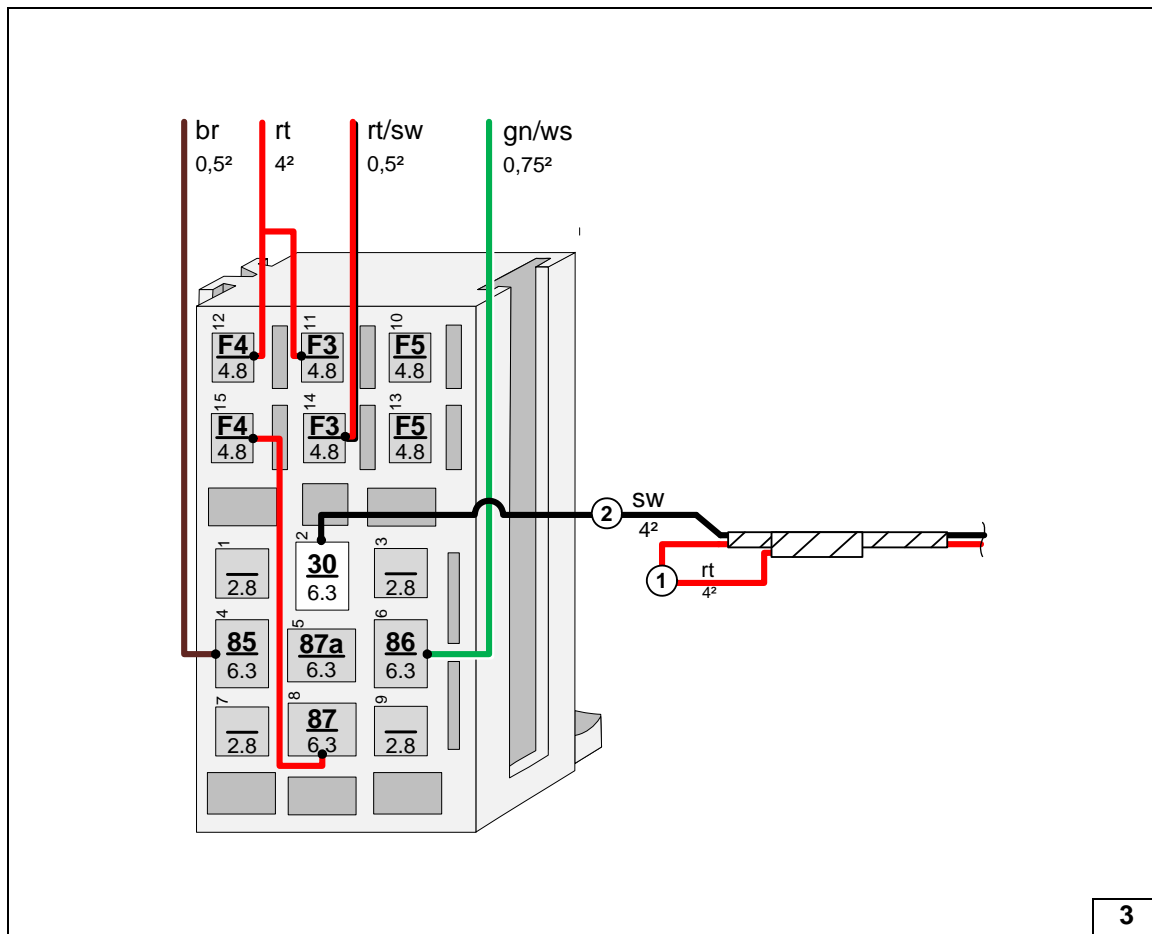

Connecting black (sw) wire ② to passenger compartment relay and fuse holder, insulating and tying back red (rt) wire ①

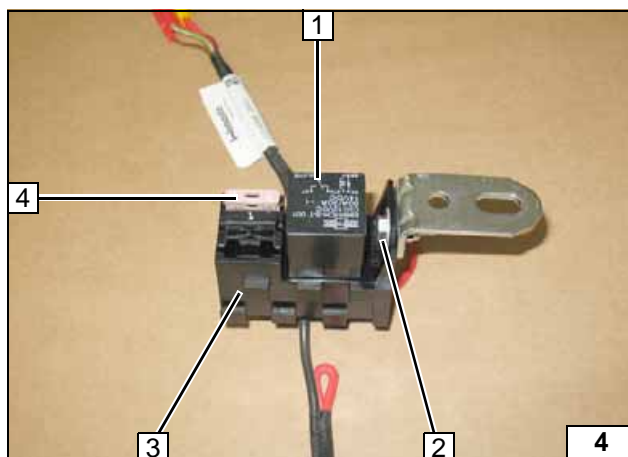

- 1 K1 relay
- 2 M5x16 bolt, washer [2x], passenger compartment relay and fuse holder, angle bracket, nut
- 3 Passenger compartment relay and fuse holder
- 4 3A fuse F4



Preparing passenger compartment relay and fuse holder

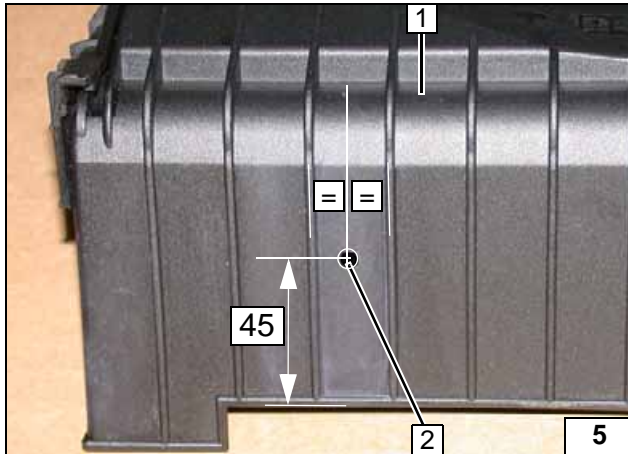
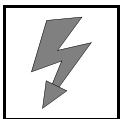

Engine compartment fuse holder

- 1 Cover of fuse/relay carrier in engine compartment
- 2 5mm dia. hole

Hole in cover

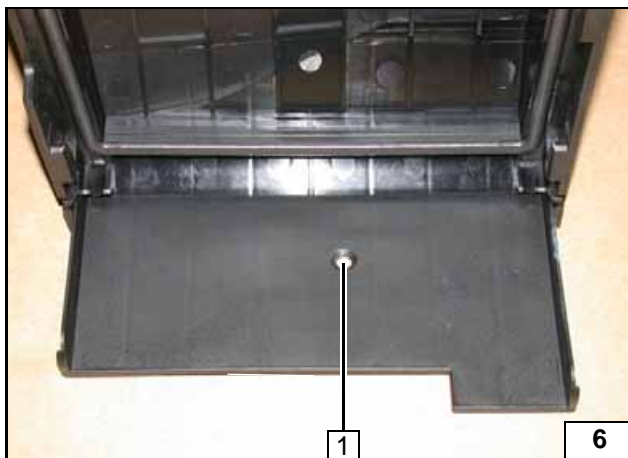

Countersink 5 mm dia. holes 1 from behind for M5 countersunk head screws.



Counter-sinking hole

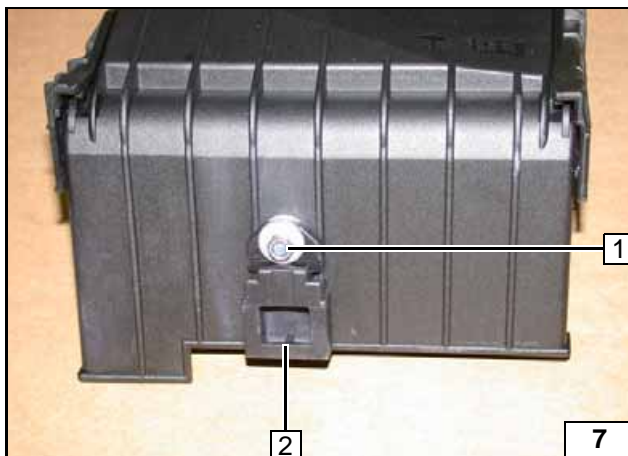

- 1 Self-locking nut, large diameter washer, engine compartment fuse holder 2, large diameter washer, M5x12 countersunk head screw

Installing engine compartment fuse holder

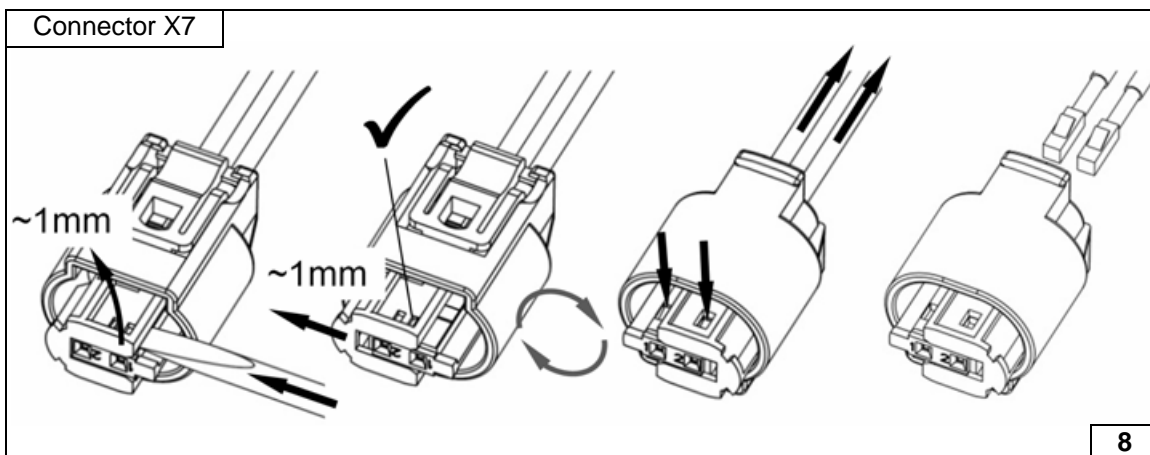

Dismantling metering pump connector



Electrical System



Wiring harness routing

See following page for routing.

- 1 Heater wiring harness in 10mm dia. corrugated tube
- 2 Engine compartment fuse holder, attached

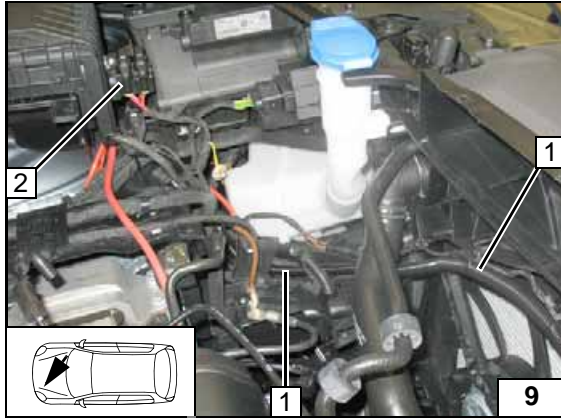

Wiring harness pass through

- 1 Protective rubber plug
- 2 Wiring harnesses of heater, heater control

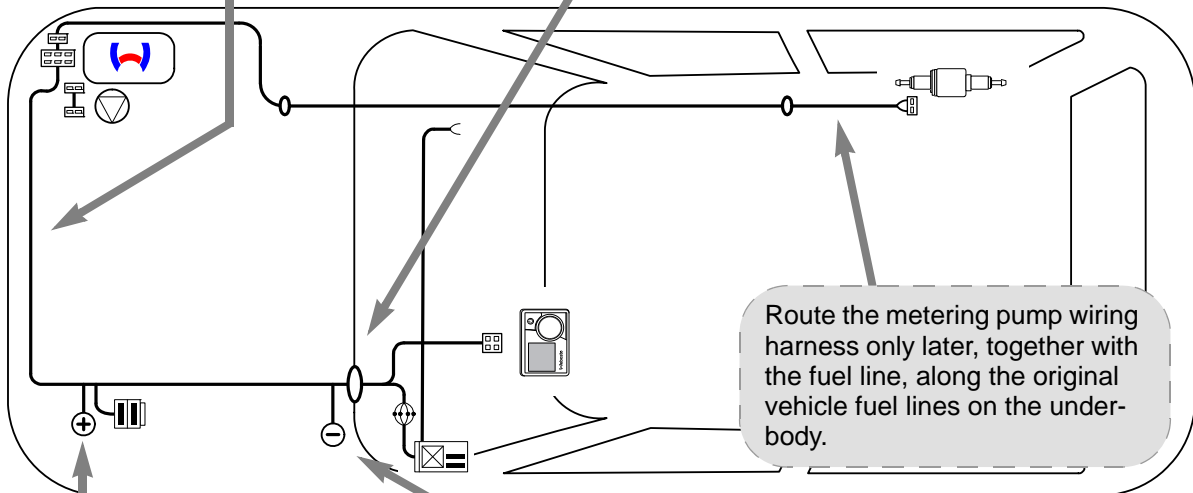
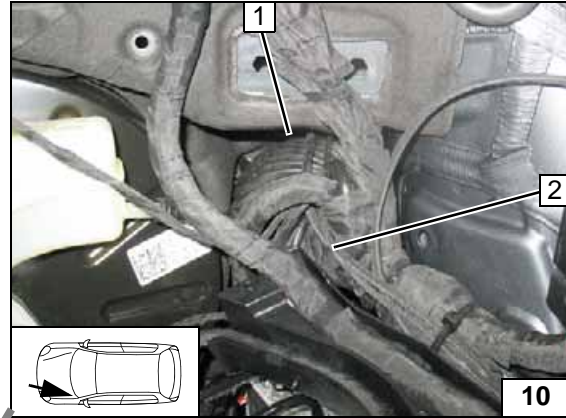

Wiring harness routing diagram

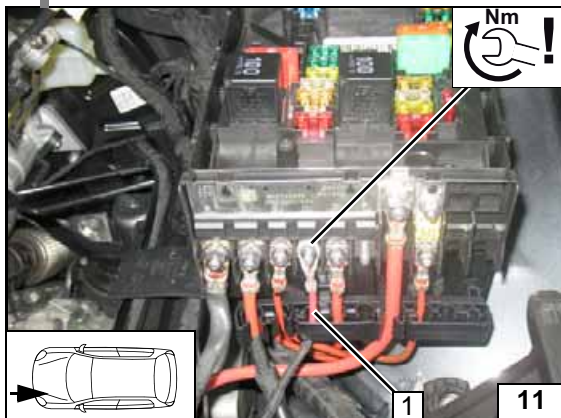

Positive wire

- 1 Positive wire on positive distributor

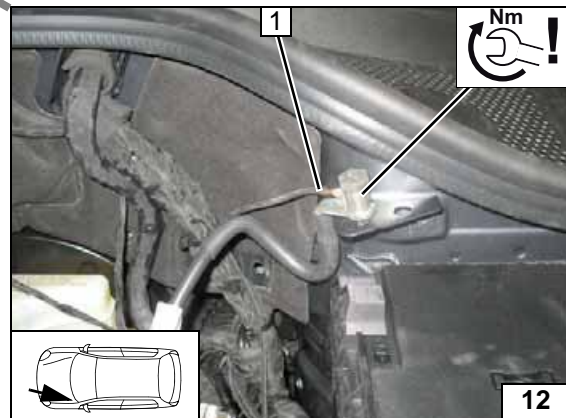

Earth wire

- 1 Earth wire on original vehicle earth point



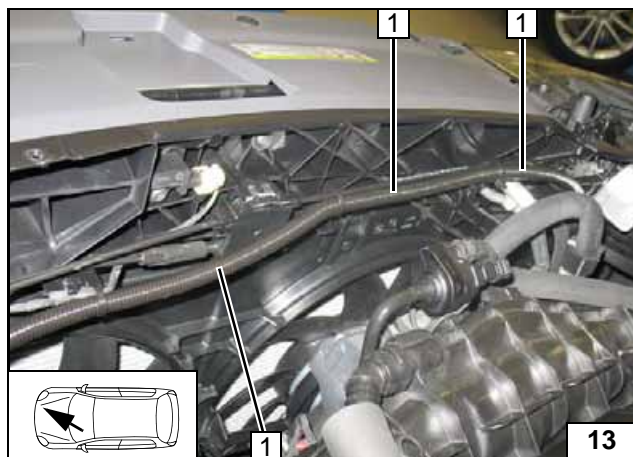

Wiring Harness Routing

- 1 Wiring harness of heater in 10mm dia. corrugated tube (sliced open 1440mm lengthwise)

Routing wiring harness of heater

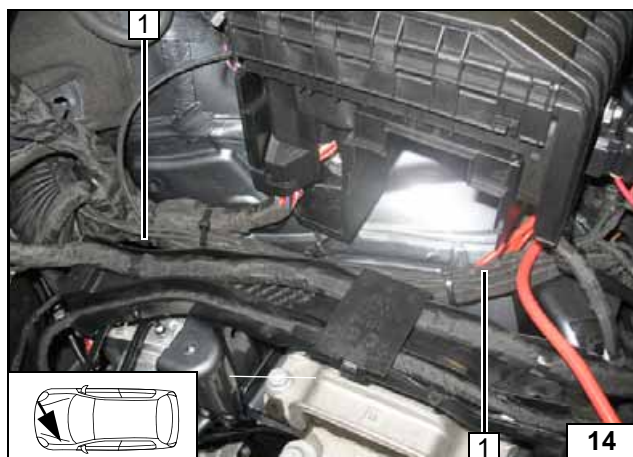

- 1 Wiring harnesses of heater, heater control

Routing wiring harnesses

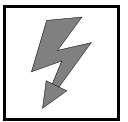

Fan Controller

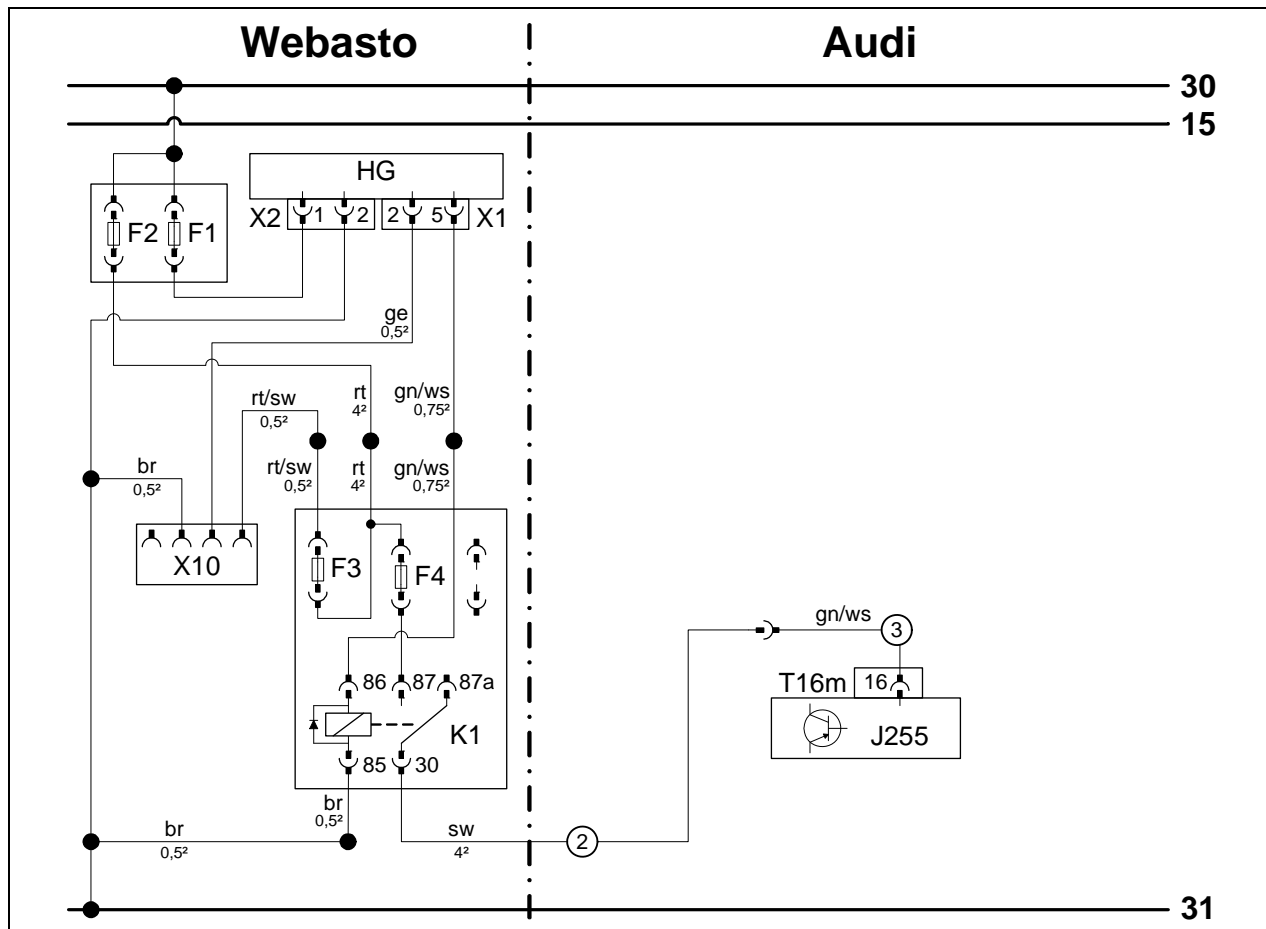

Wiring diagram

Webasto components		Vehicle components		Colours and symbols	
HG	TT-Evo heater	T16m	16-pin connector J255	rt	red
X1	6-pin heater connector	J255	A/C control unit	sw	black
X2	2-pin heater connector			ge	yellow
F1	20A fuse			gn	green
F2	30A fuse			br	brown
X10	4-pin connector of heater control			ws	white
F3	1A fuse				
F4	3A fuse			X	Cutting point
K1	Fan relay			Wiring colours may vary.	

Legend

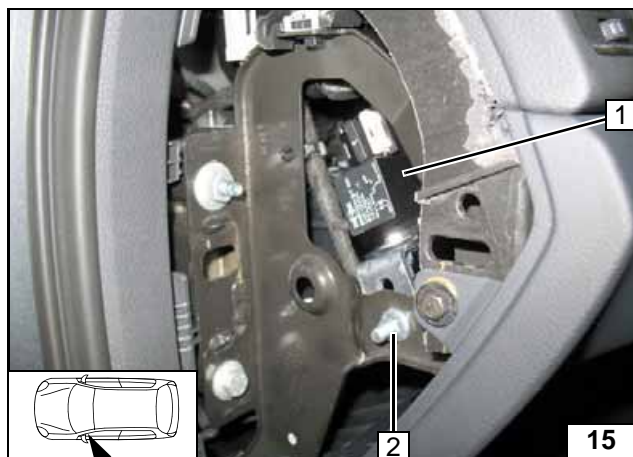

Up to MY 2014

- 1 Passenger compartment relay and fuse holder
- 2 M6 flanged nut, existing hole, pre-mounted angle bracket, M6x20 bolt



Installing passenger compartment relay and fuse holder

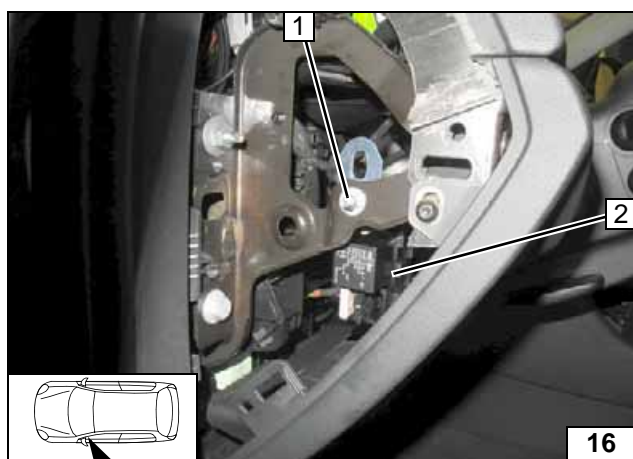

From MY 2015

- 1 M5 flanged nut, large diameter washer, existing hole, pre-mounted angle bracket, large diameter washer, M5x16 bolt
- 2 Passenger compartment relay and fuse holder



Installing passenger compartment relay and fuse holder

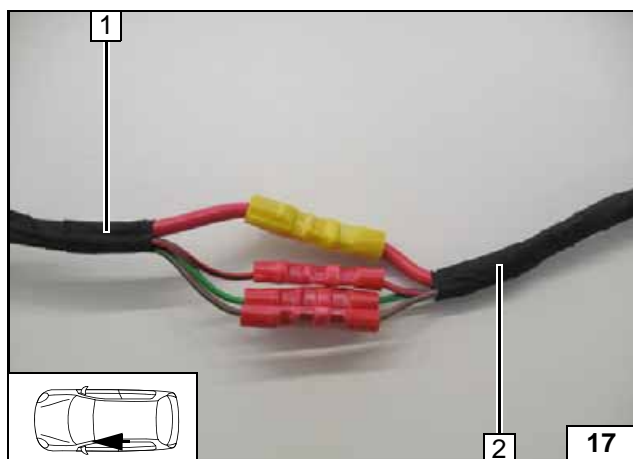

- 1 Wiring harness of passenger compartment relay and fuse holder
- 2 Wiring harness of heater

Connecting same colour wires of wiring harnesses

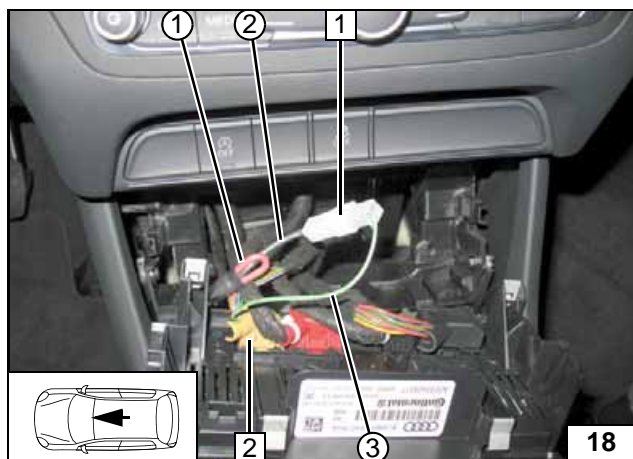

Crimp microtimer onto green/white (gn/ws) additional wire ③ and insert into free socket, pin 16, of connector T16m 2.

- 1 Connector
- 2 16-pin connector T16m of A/C control unit
- ① Insulate and tie back red (rt) wire of fan wiring harness
- ② Black (sw) wire of K1/30, fan wiring harness



Connecting A/C control unit

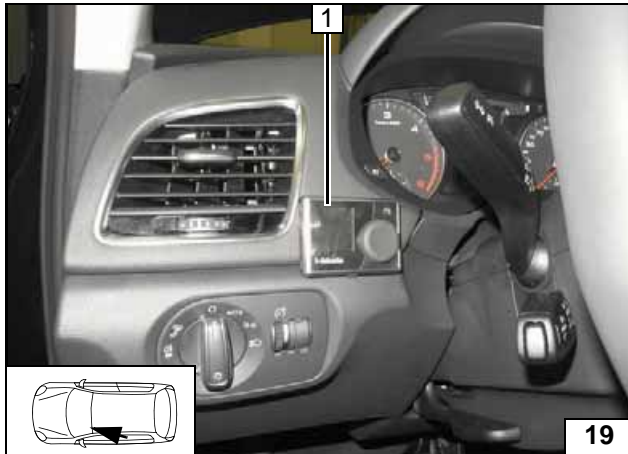
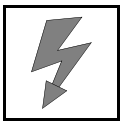

MultiControl CAR Option

- 1 MultiControl CAR



Installing
MultiControl
CAR

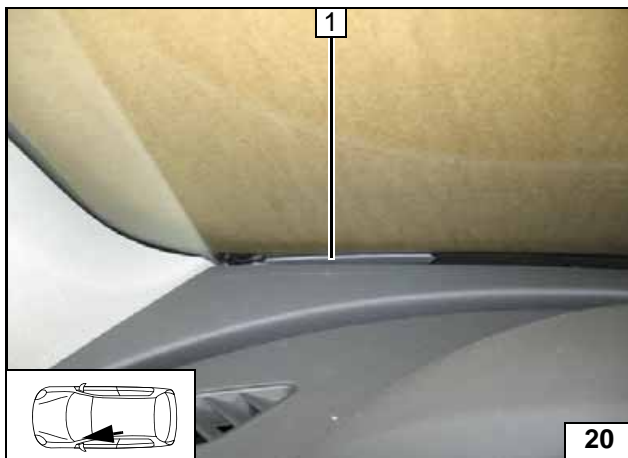

Telestart/ThermoCall Option

- 1 Aerial



Installing
aerial

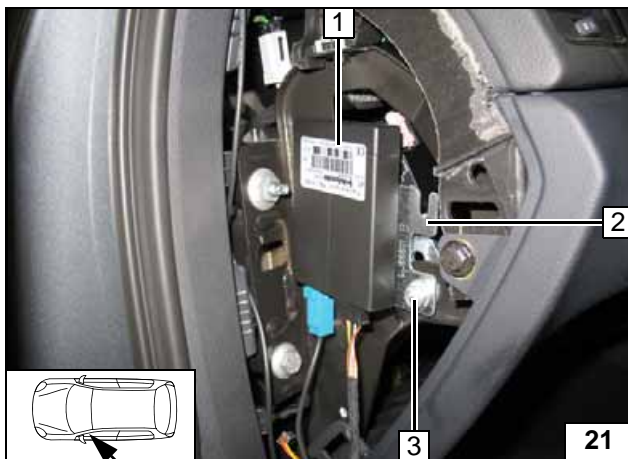

Telestart

Up to MY 2014

Drill out bracket **2** to 6.5 mm dia. at position **3**.

- 1 Receiver
- 3 M6 flanged nut, M6x20 bolt (passenger compartment relay and fuse holder)



Installing
receiver

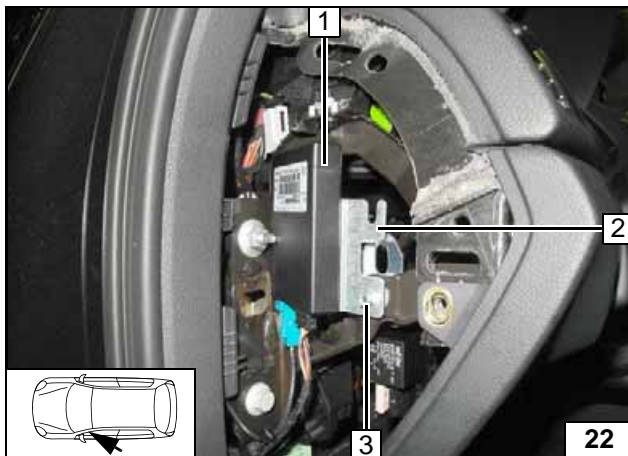

From MY 2015

- 1 Receiver
- 2 Bracket
- 3 M5 flanged nut, M5x16 bolt (passenger compartment relay and fuse holder)



Installing
receiver

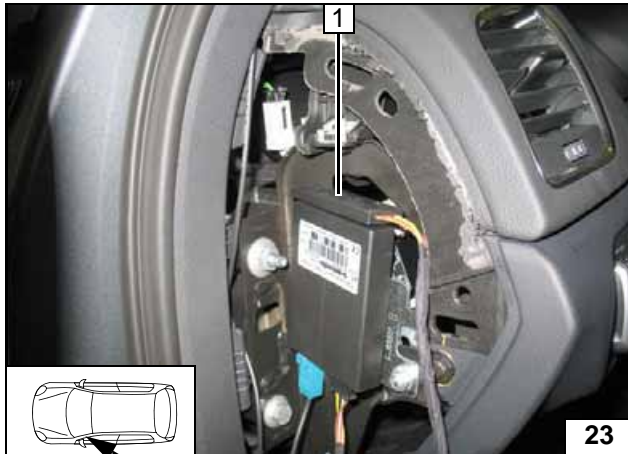
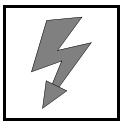

Temperature sensor T100 HTM

Up to MY 2014

Fasten temperature sensor 1 with adhesive tape.



Installing temperature sensor

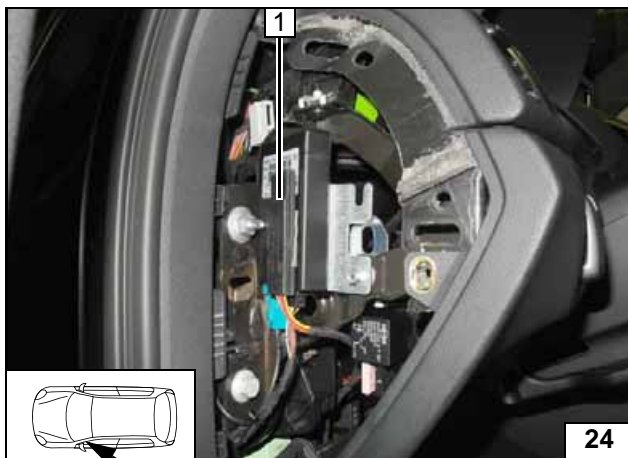

From MY 2015

Fasten temperature sensor 1 with adhesive tape.



Installing temperature sensor

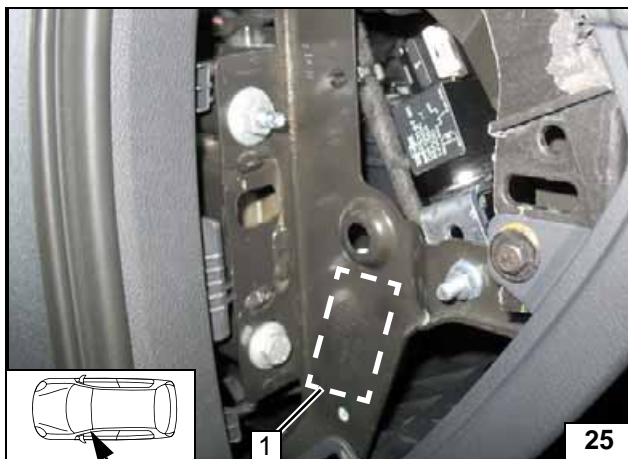

ThermoCall

Up to MY 2014

Fasten receiver 1 from the inside to instrument panel carrier using suitable means.



Installing receiver

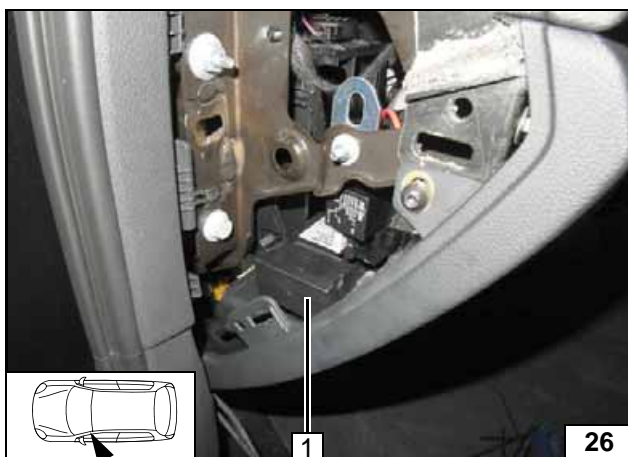

From MY 2015

Fasten receiver 1 with adhesive tape.



Installing receiver

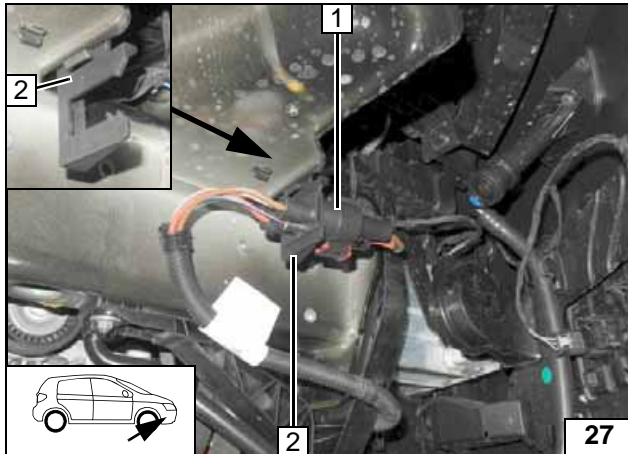
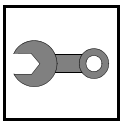

Preparing Installation Location



All vehicles

Detach original vehicle connector **1** (if present) from bracket **2**.
Remove bracket **2**.

Preparing installation location

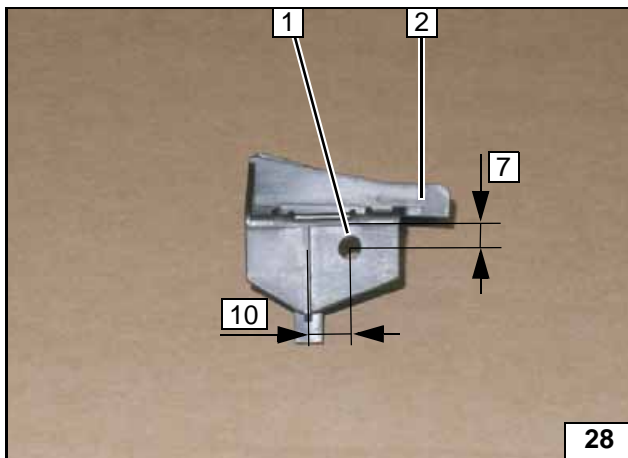

- 1 5.5 mm dia. hole
- 2 Original vehicle bracket (if present)

Adapting bracket

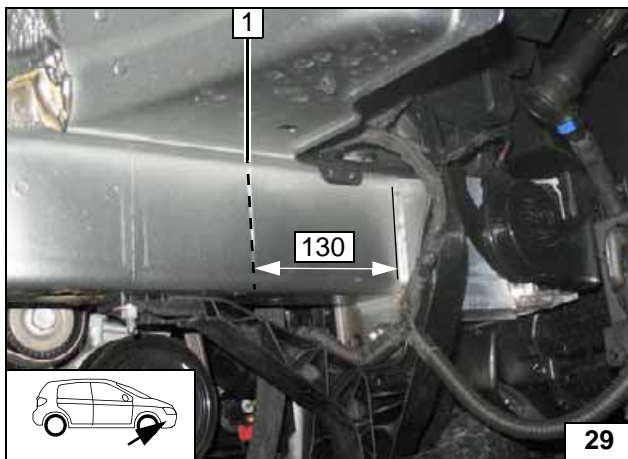

- 1 Auxiliary line

Marking auxiliary line

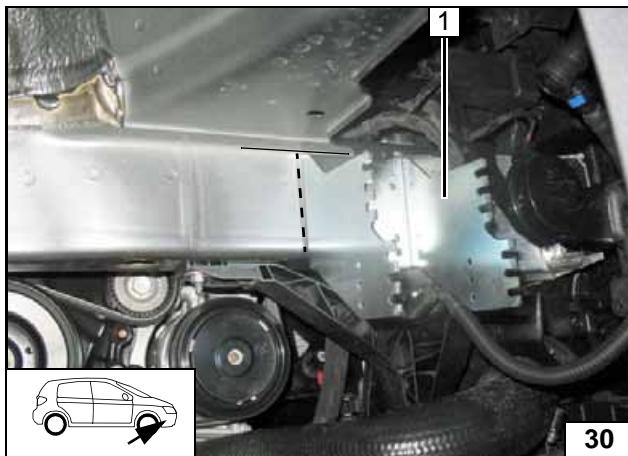

Place bracket **1** against the upper edge and align using the auxiliary line.



Placing bracket

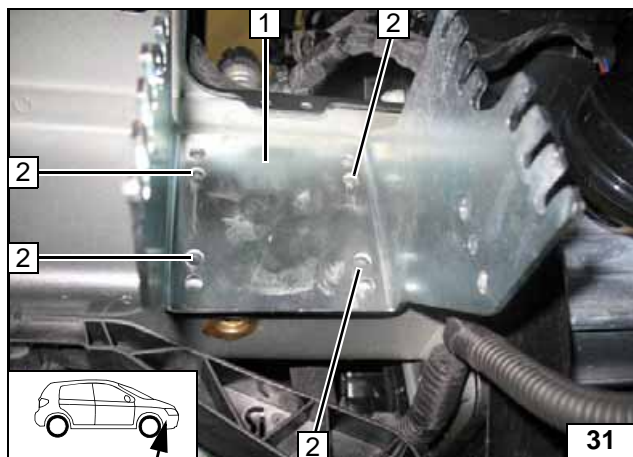

- 1 Bracket
- 2 Copy hole pattern [4x]

Copying hole pattern

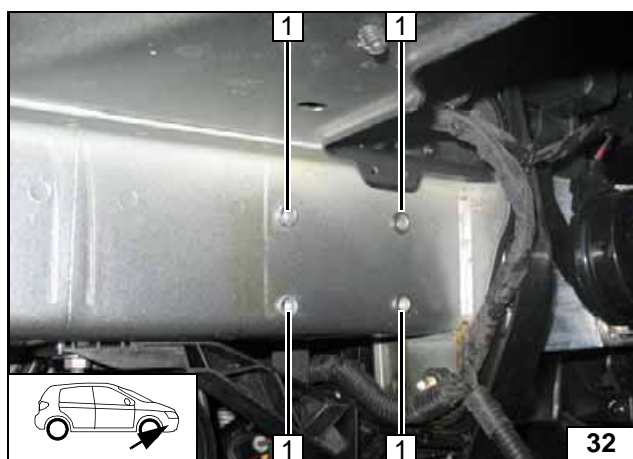

- 1 9.1 mm dia. hole; rivet nut [4x each]

Installing rivet nut

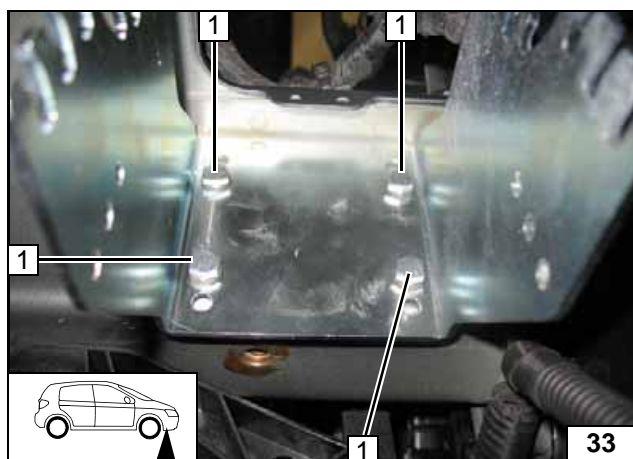

- 1 M6x20 bolt, spring lockwasher [4x each]

Installing bracket

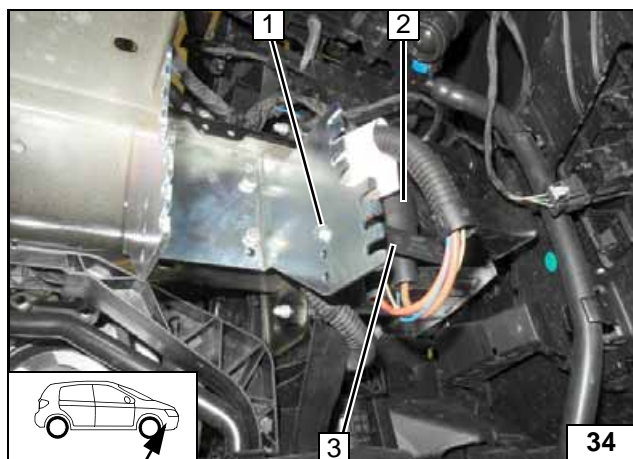

- 1 M5x16 bolt, existing hole, original vehicle bracket 3, flanged nut
- 2 Original vehicle connector

Refastening connector

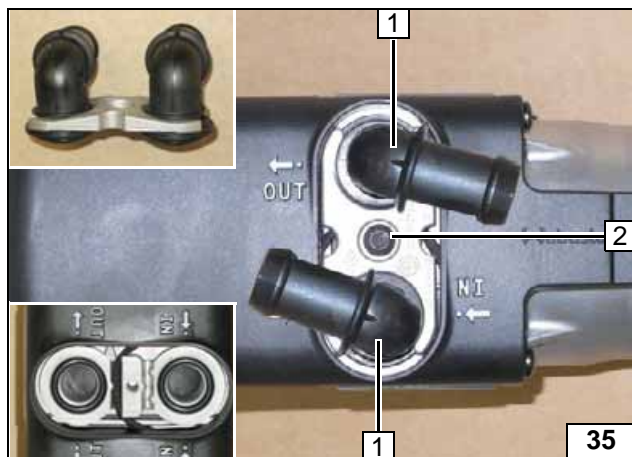

Preparing Heater

- 1 Water connection piece, sealing ring [2x each]
- 2 5x15 self-tapping bolt, retaining plate of water connection piece



Installing water connection piece

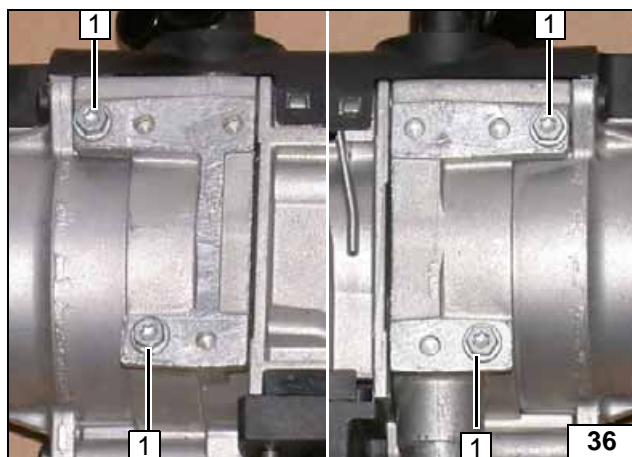

Screw 5x13 self-tapping bolts **1** [4x] into existing holes by a maximum of 3 thread turns.



Premounting bolts loosely

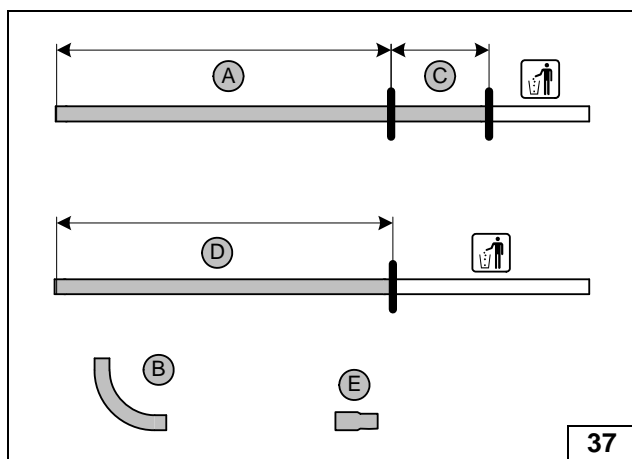

Hose **B** = 90°, 18mm dia. moulded hose.
Hose **E** = 18x20mm dia. moulded hose (only in case of 2.0 TFSI)!



Hose:	A	C	D
1.4 TFSI 110KW	= 1330	60	1280
2.0 TFSI 125/155KW	= 1280	60	1260
2.0 TDI 103/120/130KW	= 1380	60	1350
2.0 TDI 135KW	= 1160	60	1160

Cutting hoses to length

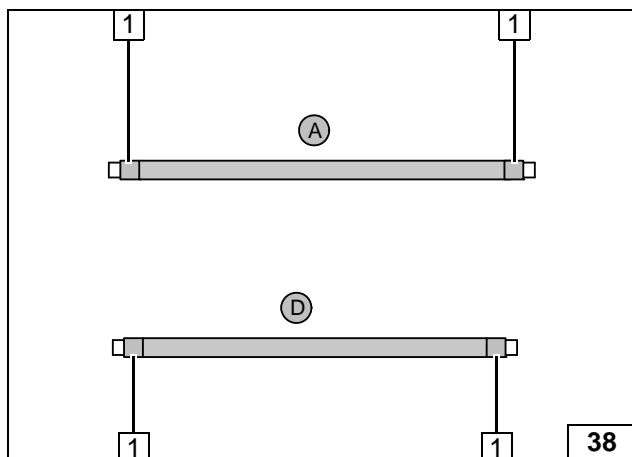

Slide on braided protection hoses and cut to length.

- 1 Cut heat shrink plastic tubing to size, 50mm long [4x]



Installing braided protection hoses

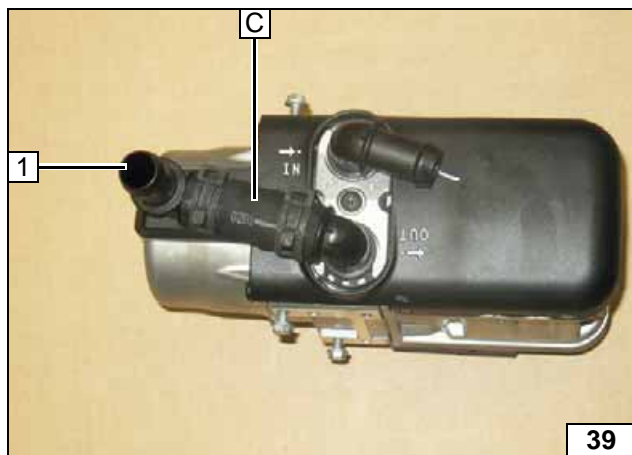

All spring clips = 25 mm dia.

- 1 90°, 18x18mm dia. connecting pipe



Premounting hose C

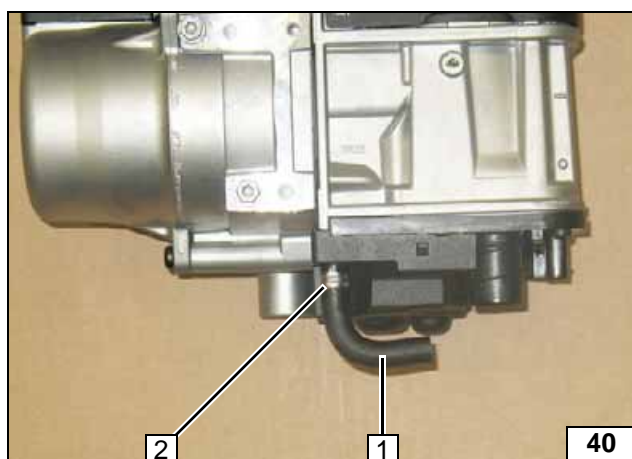

- 1 90° moulded hose
- 2 10 mm dia. clamp

Premounting moulded fuel hose

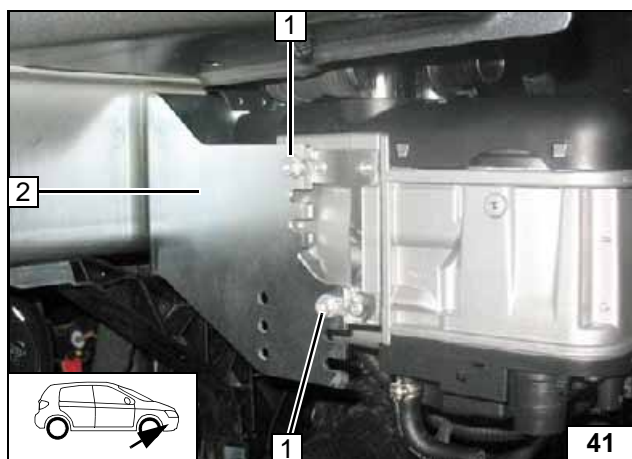

Installing Heater

Install the heater in bracket **2** and tighten 5x13 self-tapping bolt **1** [4x] (2 bolts on the opposite bracket side).



Installing heater



Coolant Circuit Diagrams

2.0 TFSI 125/155 KW





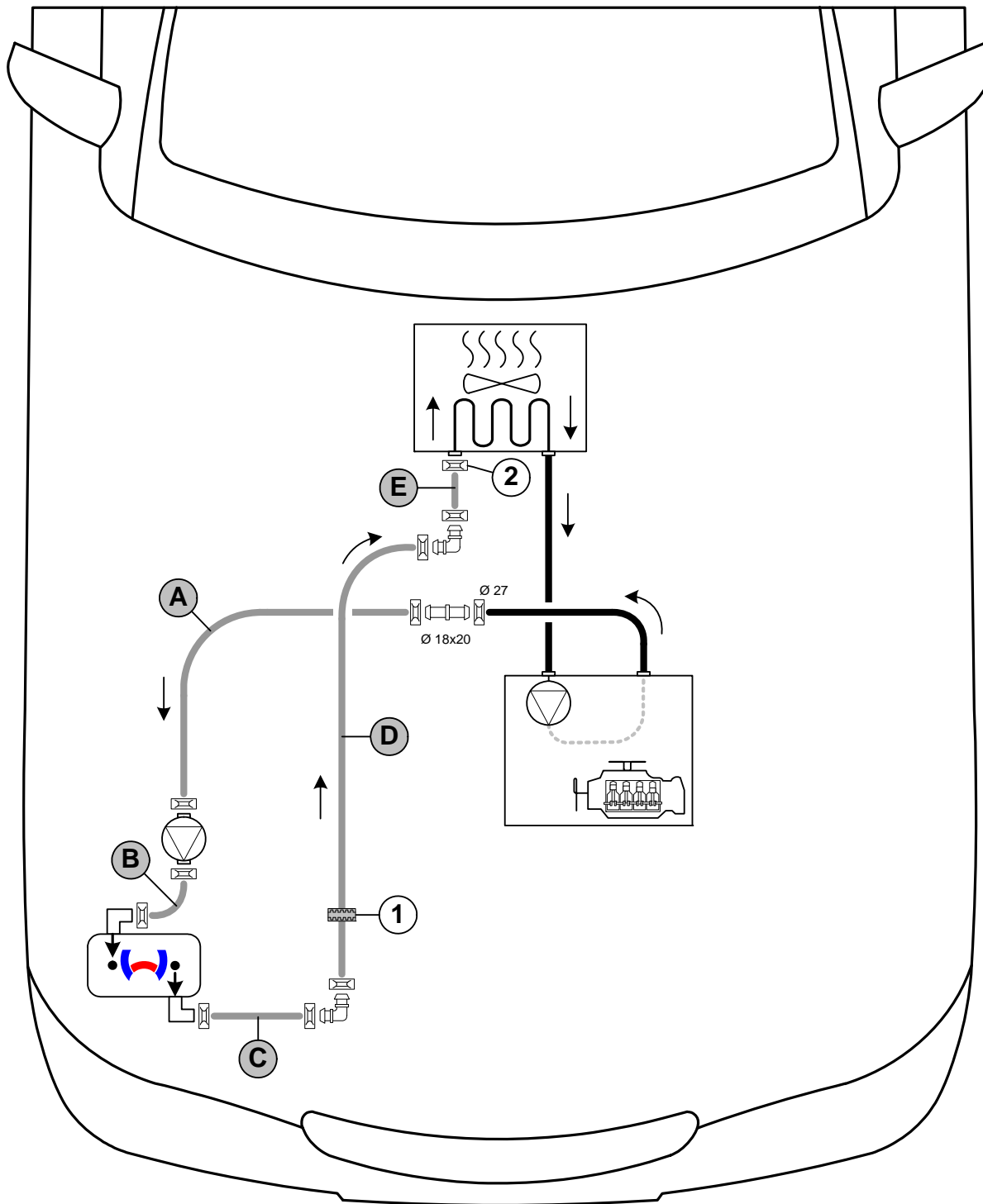

Any coolant running off should be collected in an appropriate container. Route hoses kink-free. Unless specified otherwise, always fasten using cable ties. Position clamps so that other hoses cannot be damaged. The heater must be filled with coolant when installing the hoses.

The connection should be modelled on an 'inline' circuit and based on the following diagram:



Hose routing diagram

All spring clips without a specific designation  = 25 mm dia. **2** = Original vehicle spring clip .
1 = Black (sw) rubber isolator .
 All connecting pipes  = 18x18 mm dia.





1.4 TFSI 110 KW/ 2.0TDI 103/120/130 KW



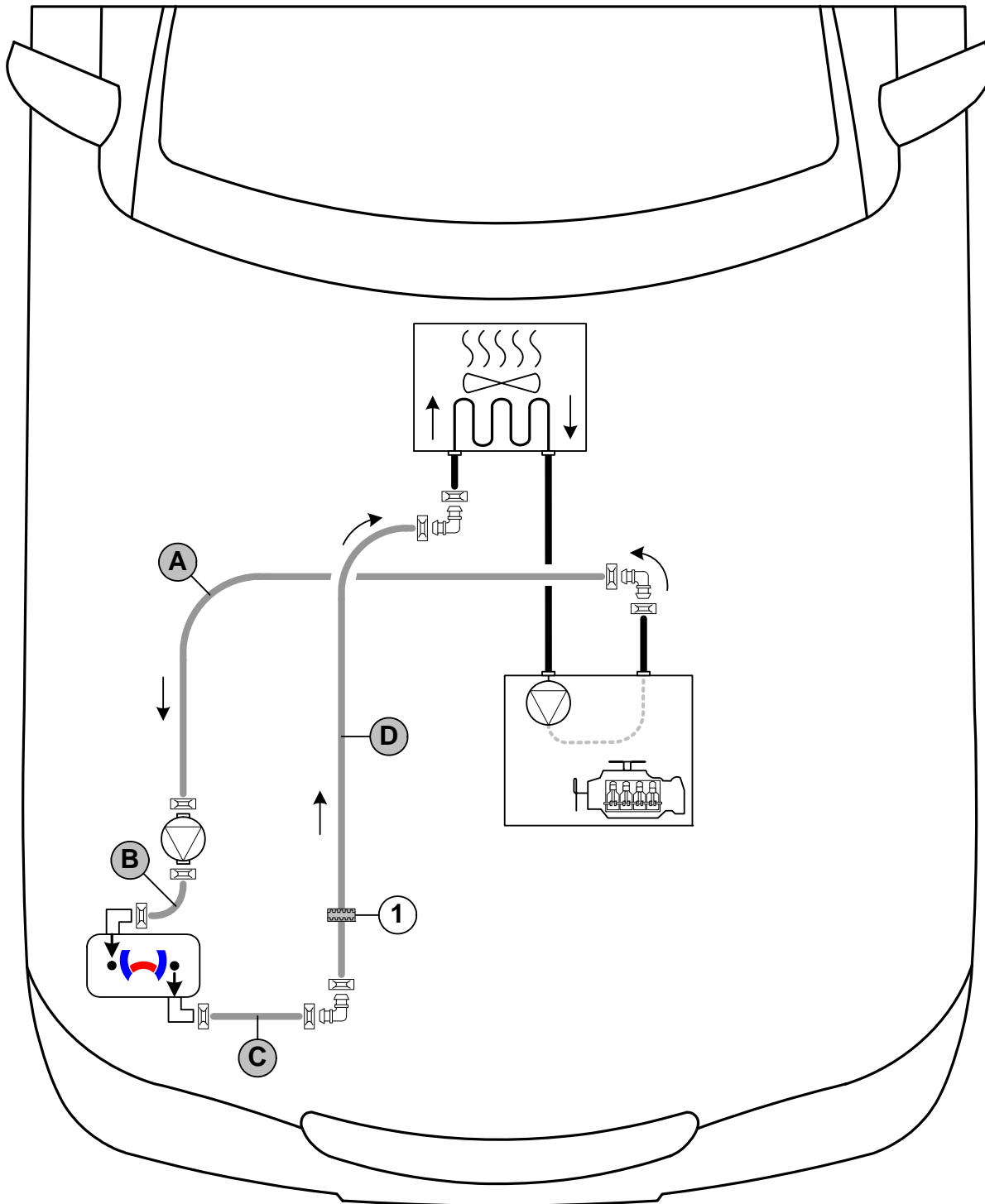

Any coolant running off should be collected in an appropriate container. Route hoses kink-free. Unless specified otherwise, always fasten using cable ties. Position clamps so that other hoses cannot be damaged. The heater must be filled with coolant when installing the hoses.

The connection should be modelled on an 'inline' circuit and based on the following diagram:



Hose routing diagram

All spring clips  = 25mm dia.
 1 = Black (sw) rubber isolator .
 All connecting pipes  = 18x18 mm dia.





2.0 TDI 135 KW



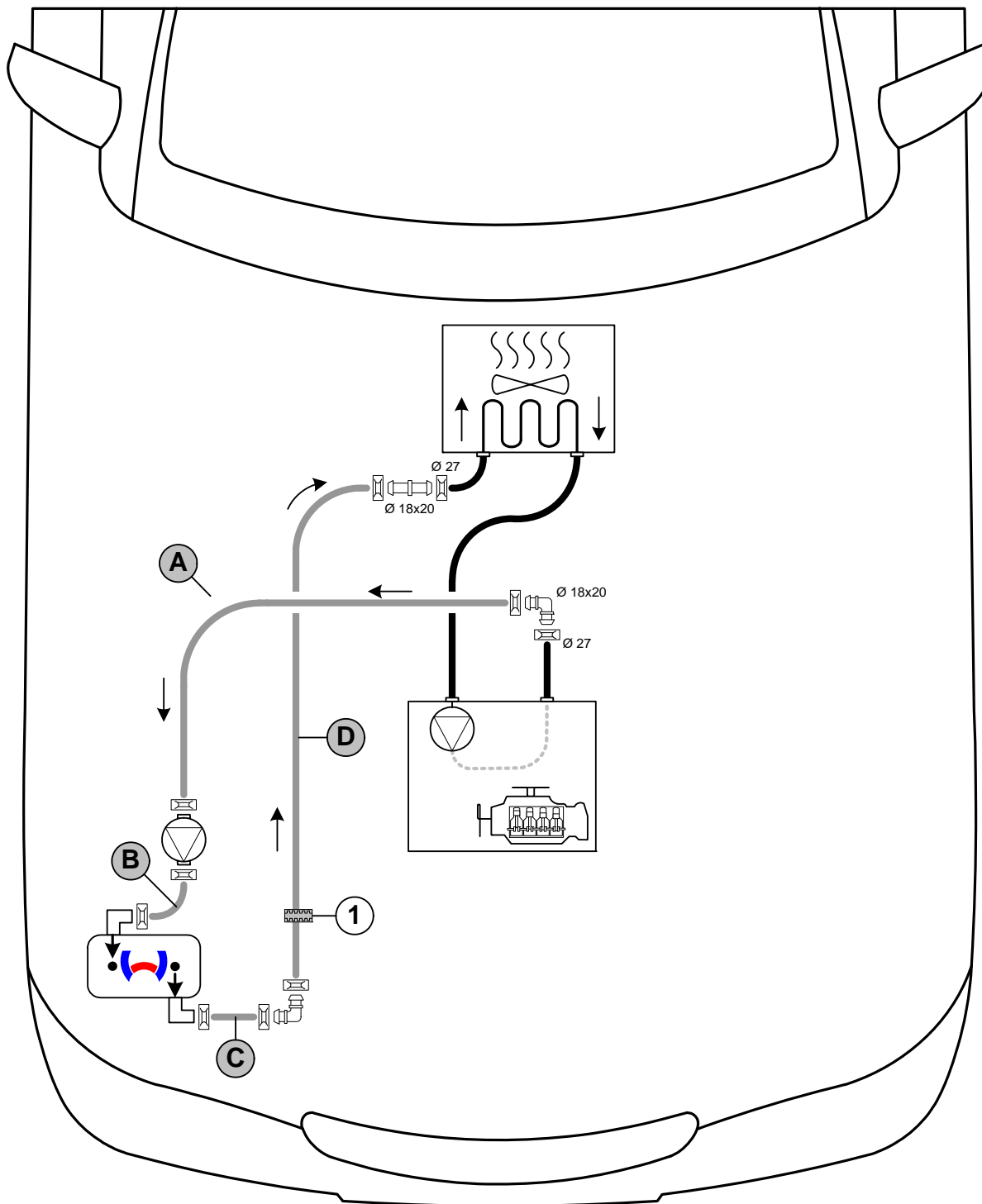

Any coolant running off should be collected in an appropriate container. Route hoses kink-free. Unless specified otherwise, always fasten using cable ties. Position clamps so that other hoses cannot be damaged. The heater must be filled with coolant when installing the hoses.

The connection should be modelled on an 'inline' circuit and based on the following diagram:



Hose routing diagram

All spring clips without a specific designation  = 25 mm dia.

1 = Black (sw) rubber isolator .

All connecting pipes without a specific designation  = 18x18mm dia.



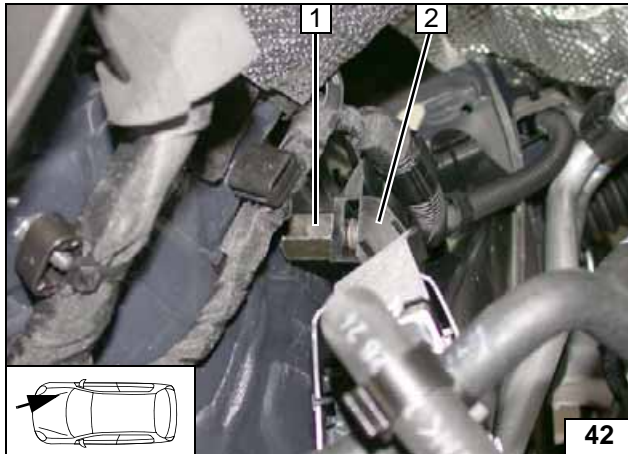

Coolant Circuit

All the following figures depict petrol vehicles. The individual working steps are nearly identical for both petrol and diesel vehicles!

Detach plastic shaft **2** and discard original vehicle's nut.

- 1** M6x20 spacer nut, M6x12 bolt, spring lockwasher, washer

Preparing routing of hoses

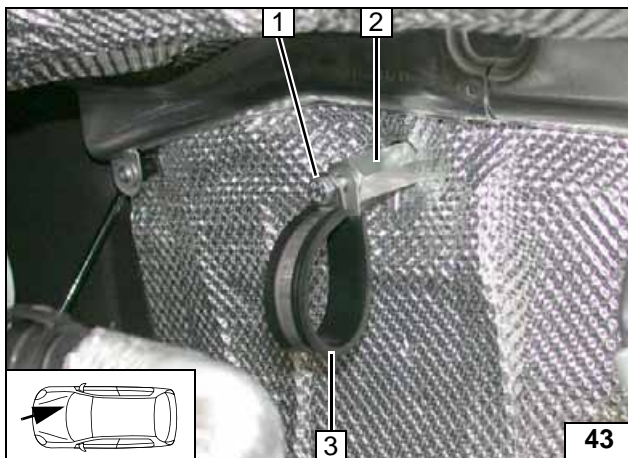

- 1** Loosely install M6x16 bolt, spring lockwasher
- 2** M6x40 spacer nut, available stud bolt
- 3** 38 mm dia. rubber-coated p-clamp

Preparing routing of hoses

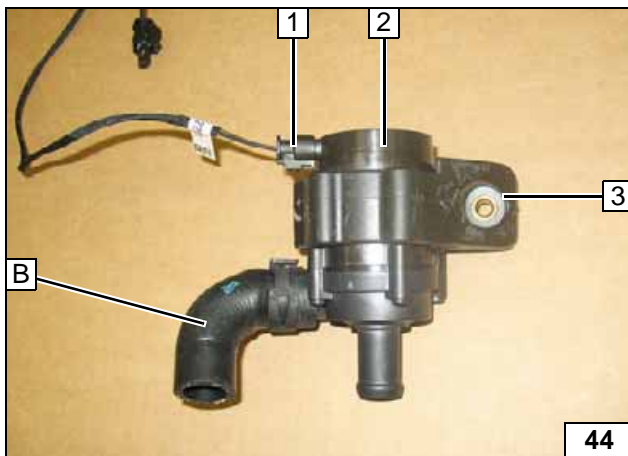

- 1** Connector of circulating pump wiring harness
- 2** Circulating pump
- 3** Circulating pump mount

Premounting circulating pump

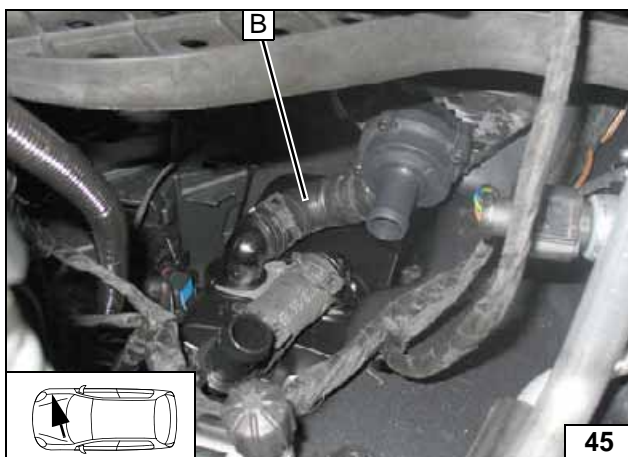

Connecting heater inlet

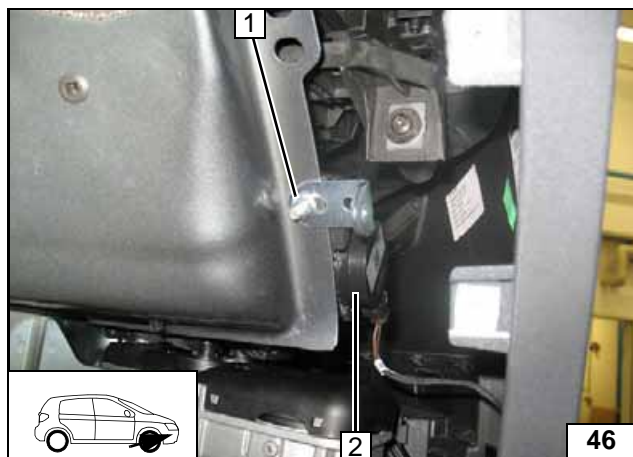

- 1 M6 flanged nut, angle bracket, existing hole, M6x25 bolt
- 2 Circulating pump

Installing circulating pump

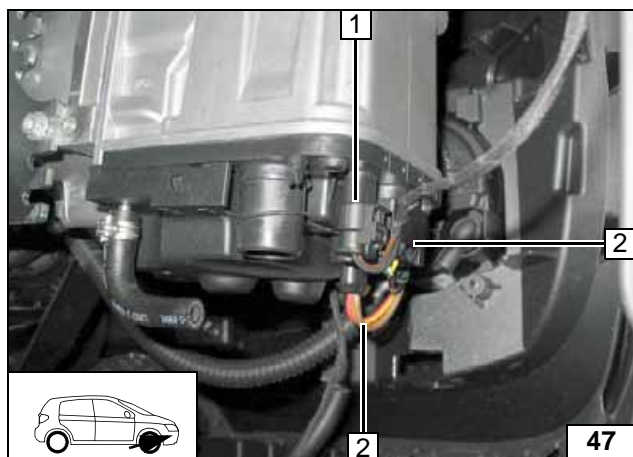

- 1 Connector of circulating pump wiring harness
- 2 Connector of heater wiring harness [2x]

Installing wiring harnesses

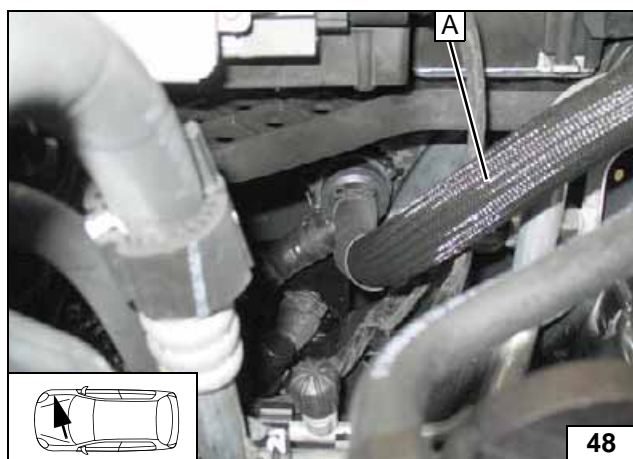

Connecting hose A to circulating pump inlet

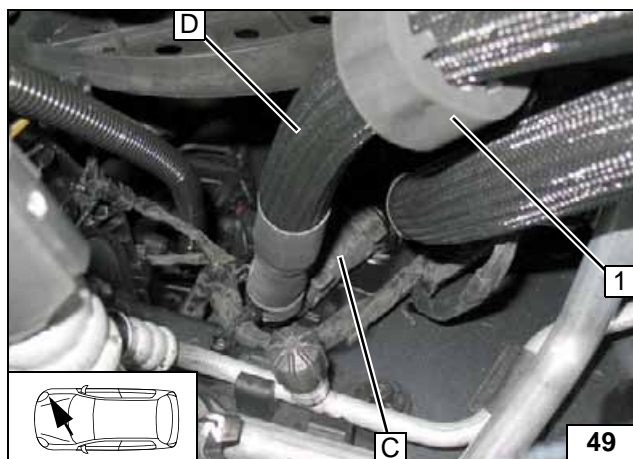

Push black (sw) rubber isolator 1 onto hose D and align.



Connecting hose C and D

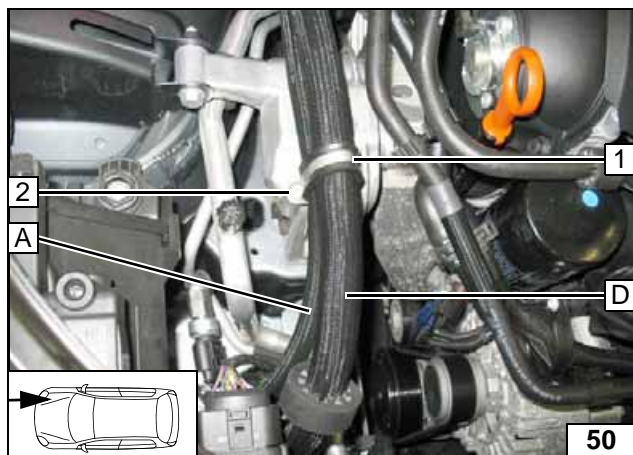

Petrol

Figure shows 2.0 TFSI, applies here and for all next figures!

- 1 38 mm dia. rubber-coated p-clamp
- 2 M6x20 bolt, spring lockwasher, existing threaded hole

Routing in engine compartment

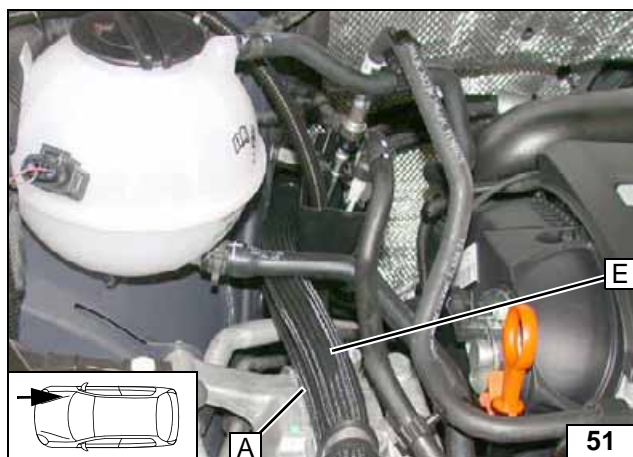

Routing in engine compartment

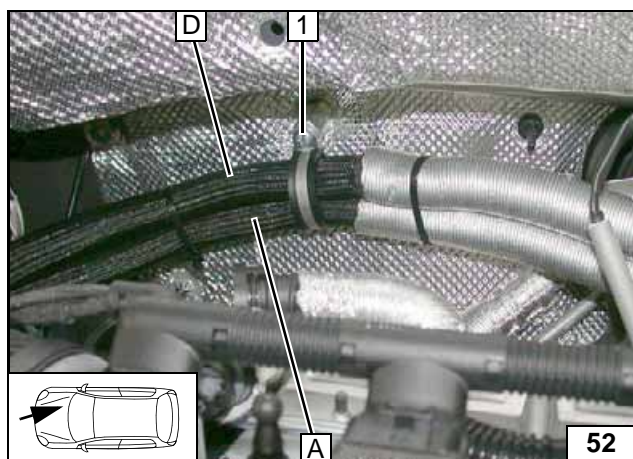

Route hoses **A** and **D** through rubber-coated p-clamp. Split heat protection hose in the middle and push one end each on hoses **A** and **D**.

- 1 Tighten M6x16 bolt

Routing in engine compartment

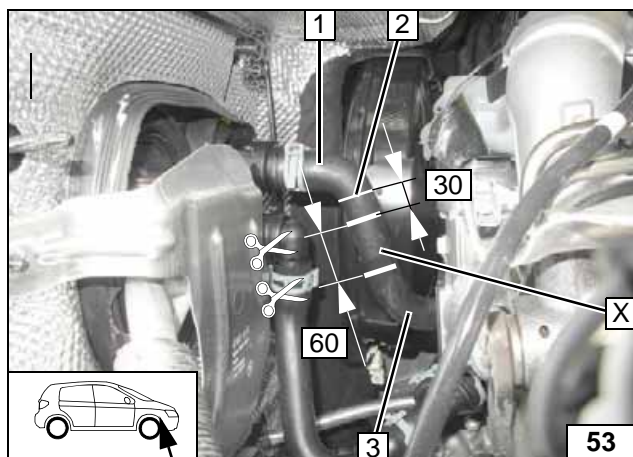

1.4 TFSI

- 1 Hose section of heat exchanger inlet
- 2 Starting point of measurement, directly behind 90° elbow
- 3 Hose section of engine outlet

X =

Cutting point

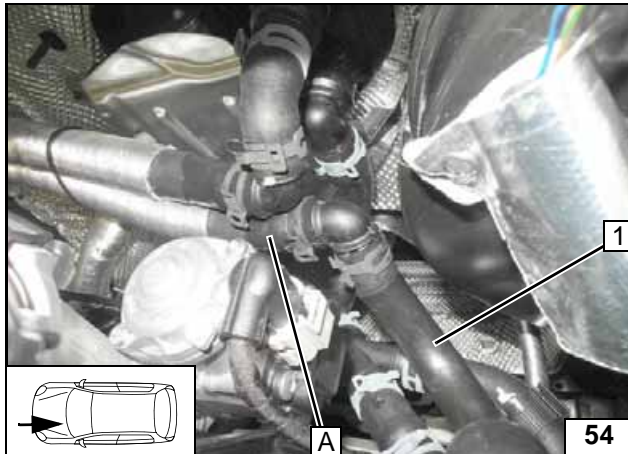

1 Hose section of engine outlet

Connect-
ing engine
outlet

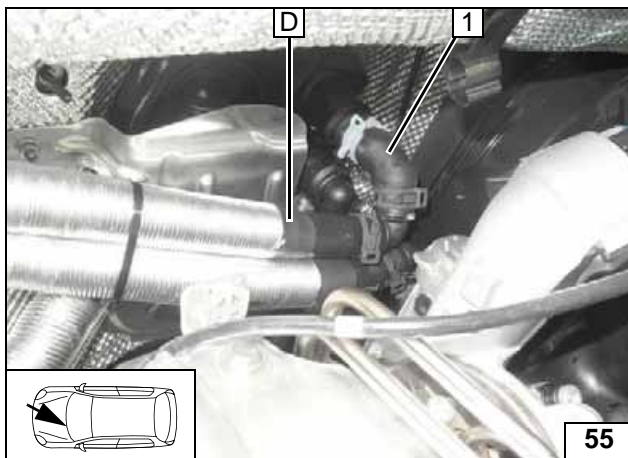

Align hoses. Ensure sufficient distance from neighbouring components.



1 Hose section of heat exchanger inlet

Connect-
ing heat ex-
changer
inlet

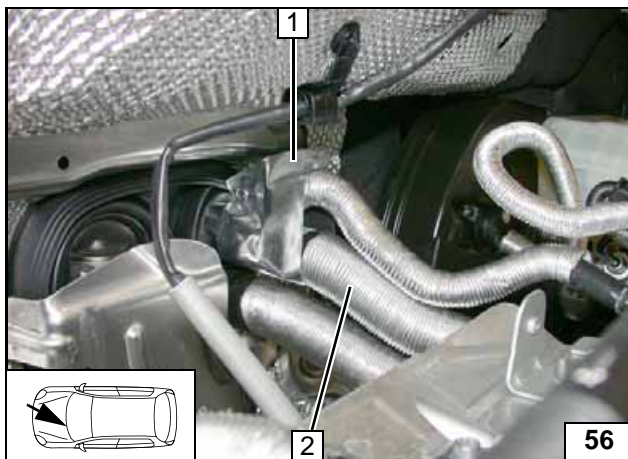

2.0 TFSI

Remove protection tape 1, will be reused. Slide heat protection hose 2 onto engine outlet / heat exchanger inlet hose.



Cutting
point

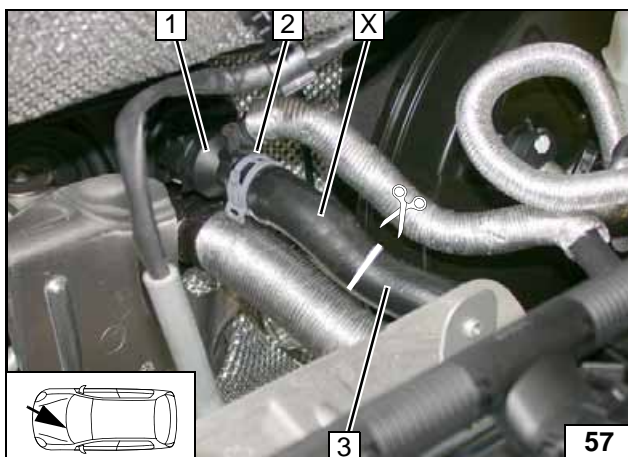

- 1 Coupling of heat exchanger inlet
- 2 Spring clip, will be reused
- 3 Hose section of engine outlet

X =

Cutting
point

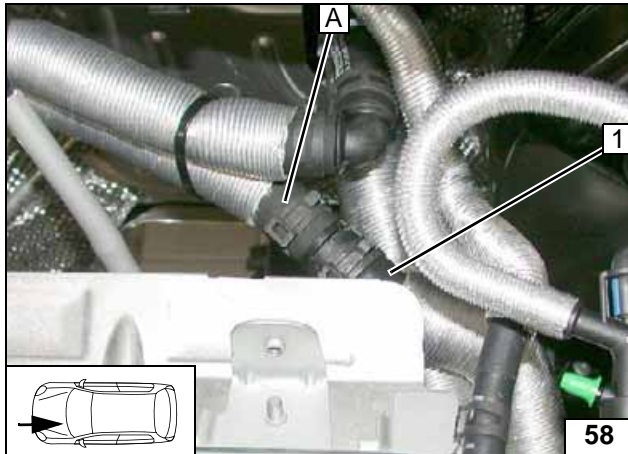

1 Hose section of engine outlet

Connect-
ing engine
outlet

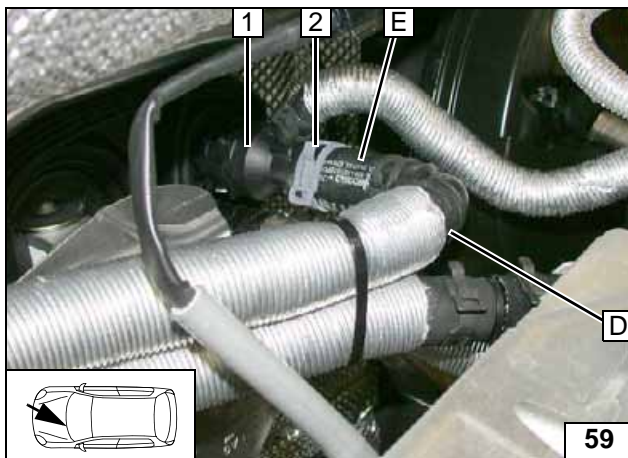

1 Coupling of heat exchanger inlet
2 Original vehicle spring clip

Connect-
ing heat ex-
changer
inlet

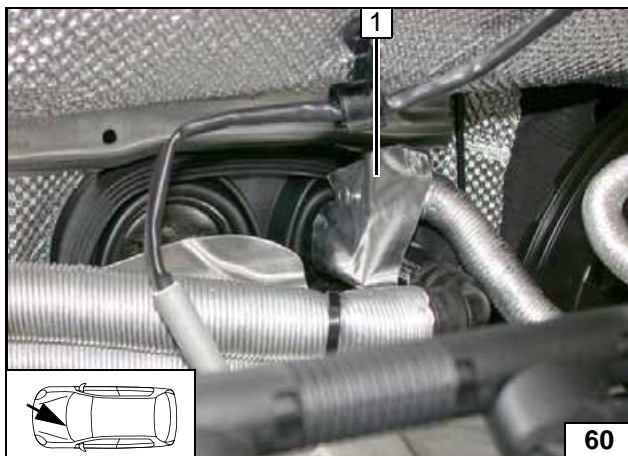

Place back protection tape 1. Align hoses. Ensure sufficient distance from neighbouring components.



Mounting
protection
tape

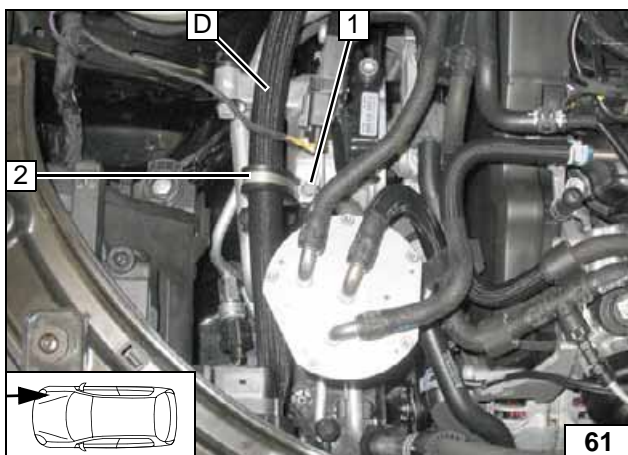

Diesel

Hose A under hose D (hidden)!

- 1 M6x20 bolt, spring lockwasher, existing threaded hole
- 2 38 mm dia. rubber-coated p-clamp



Routing in
engine
compartment

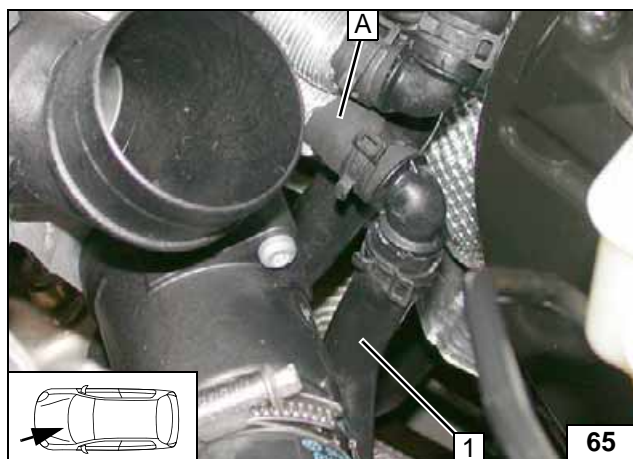
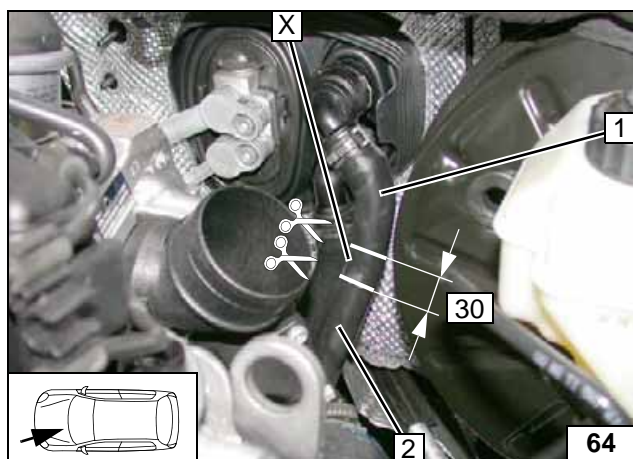
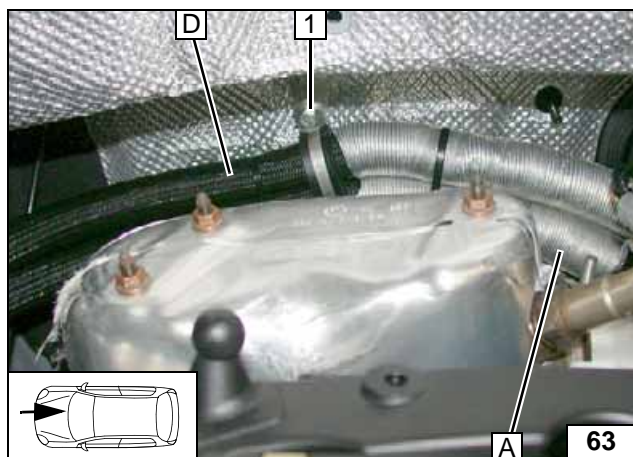
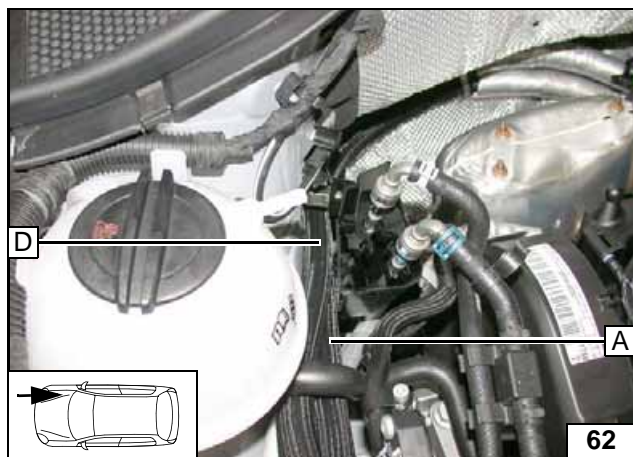

2.0 TDI 103/120/130KW

Route hoses **A** and **D** through rubber-coated p-clamp. Split heat protection hose in the middle and push one end each on hoses **A** and **D**.

- 1 Tighten M6x16 bolt

- 1 Hose section of heat exchanger inlet
- 2 Hose section of engine outlet

X =

- 1 Hose section of engine outlet

Routing in engine compartment



Routing in engine compartment

Cutting point

Connecting engine outlet

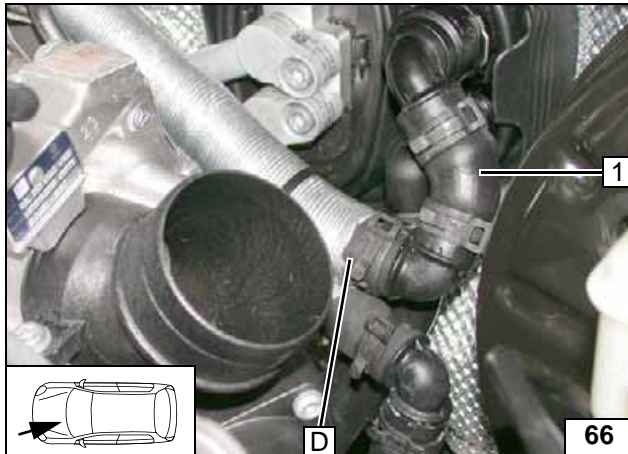

Align hoses. Ensure sufficient distance from neighbouring components.

- 1 Hose section of heat exchanger inlet



**Connect-
ing heat ex-
changer
inlet**

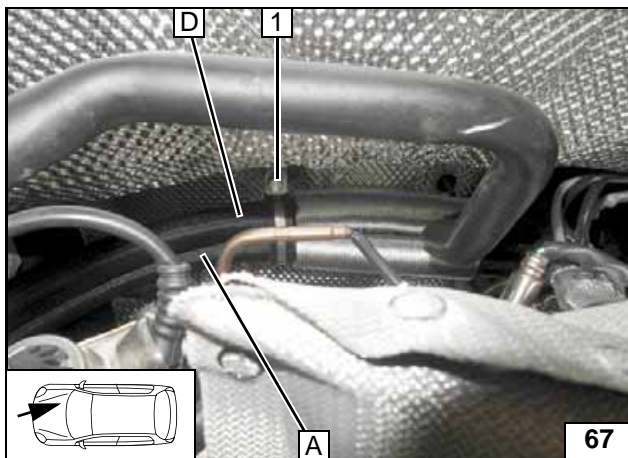

2.0 TDI 135KW

Route hoses **A** and **D** through rubber-coated p-clamp. Split heat protection hose in the middle and push one end each on hoses **A** and **D**.

- 1 Tighten M6x16 bolt



**Routing in
engine
compart-
ment**

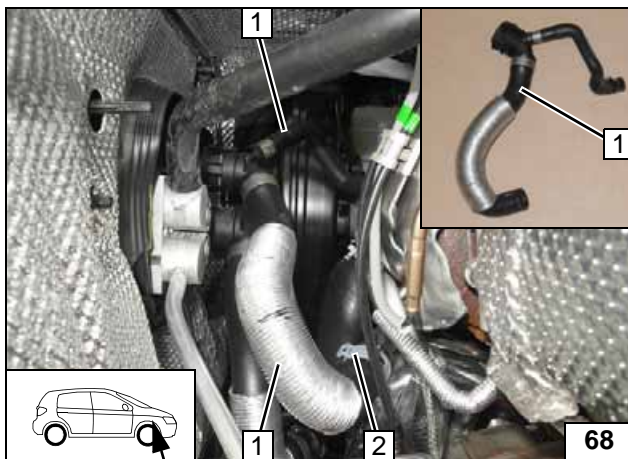

Remove hose of heat exchanger inlet **1** completely. Spring clip **2** will be reinserted.



**Cutting
point**



- 1 Hose of heat exchanger inlet
- 2 Heat protection hose

**Pulling off
heat pro-
tection
hose**

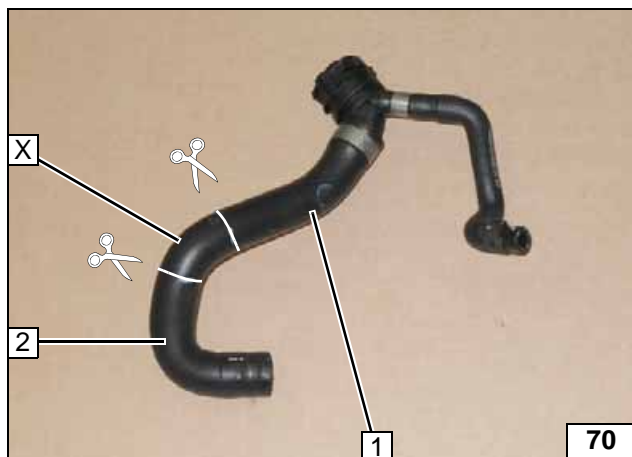

- 1 Hose section of heat exchanger inlet
- 2 Hose section of engine outlet

X =

Preparing hose of heat exchanger inlet

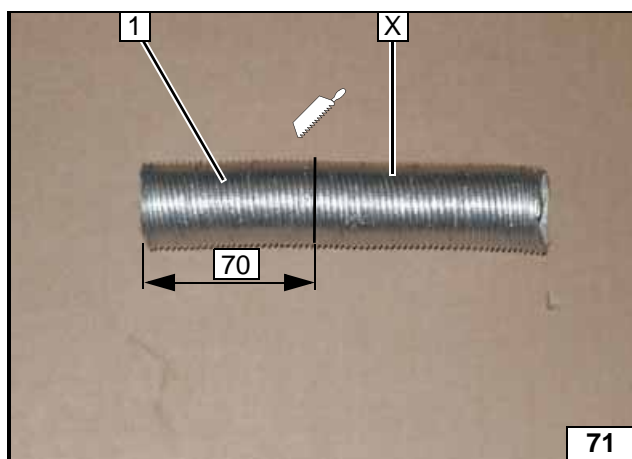

- 1 Heat protection hose

X =

Cutting heat protection hose to length

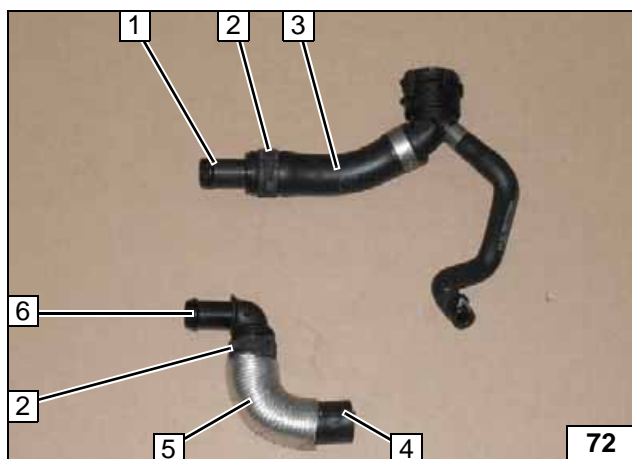

- 1 18x20mm dia. connecting pipe
- 2 27 mm dia. spring clip [2x]
- 3 Hose section of heat exchanger inlet
- 4 Hose section of engine outlet
- 5 70mm heat protection hose
- 6 90°, 18x20mm dia. connecting pipe

Preparing hoses

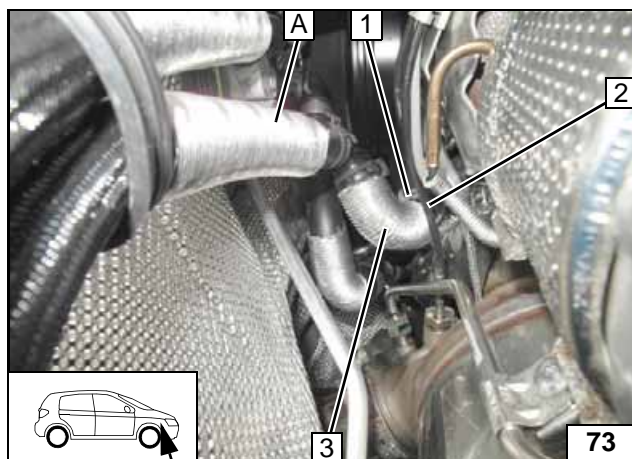

- 1 Original vehicle spring clip
- 2 Connection piece of engine outlet
- 3 Hose section of engine outlet

Connecting engine outlet

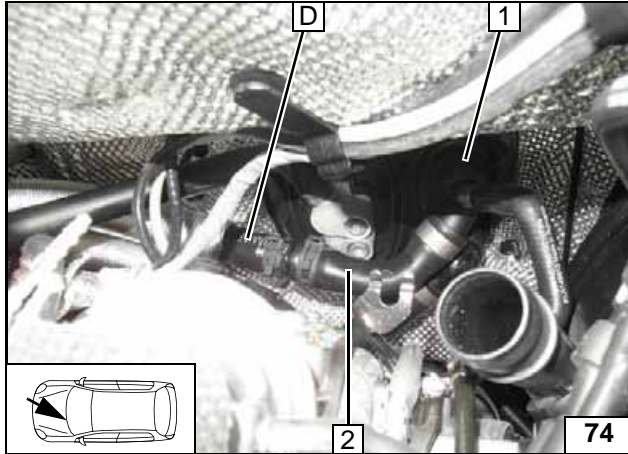
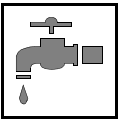

Align hoses. Ensure sufficient distance from neighbouring components.

- 1 Connection piece of heat exchanger inlet
- 2 Hose section of heat exchanger inlet



**Connect-
ing heat ex-
changer
inlet**

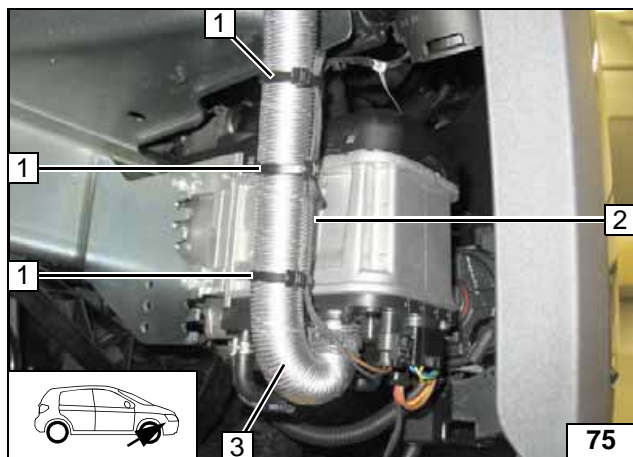
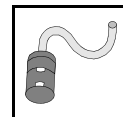

Combustion Air

- 1 Cable tie
- 2 Wiring harness of circulating pump
- 3 Combustion air pipe

Installing combustion air pipe

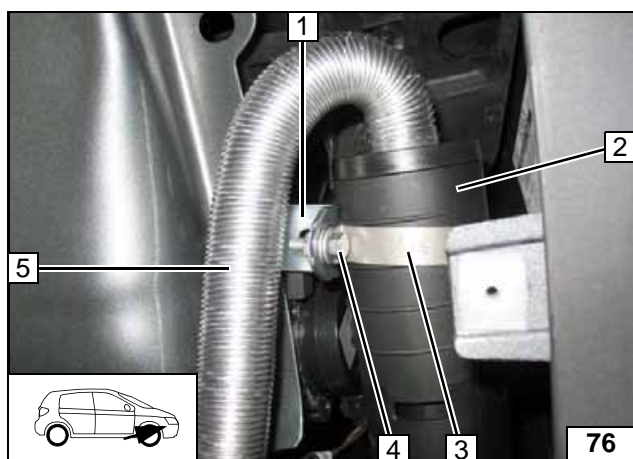

- 1 Angle bracket
- 2 Silencer
- 3 51mm dia. clamp
- 4 M5x16 bolt, flanged nut
- 5 Combustion air pipe



Installing silencer



- 1 Cable tie

Attaching combustion air pipe



Fuel



Open the vehicle's fuel tank cap, ventilate the tank and then re-close the tank lock.

Catch any fuel running off in an appropriate container.



Route fuel line and metering pump wiring harness so that they are protected against stone impact. Unless specified otherwise, always fasten using cable ties.

Provide rub protection for fuel line and wiring harness in areas where there are sharp edges.

The fuel line and wiring harness are routed to the metering pump as shown in the wiring harness routing diagram.

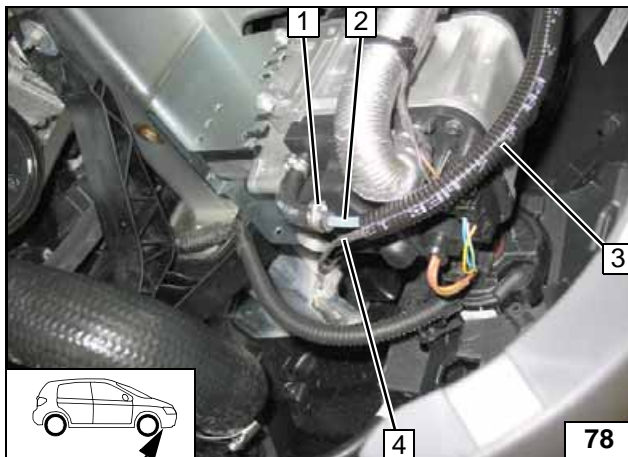

Pull fuel line **2** and metering pump wiring harness **4** into 10mm dia., 1100mm long corrugated tube **3**.

- 1 10 mm dia. clamp



**Connect-
ing heater**

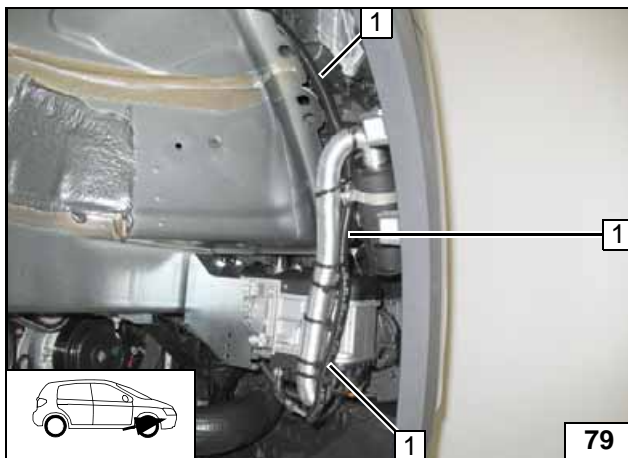

- 1 Fuel line, wiring harness of metering pump in 10mm dia. corrugated tube

**Routing
lines**

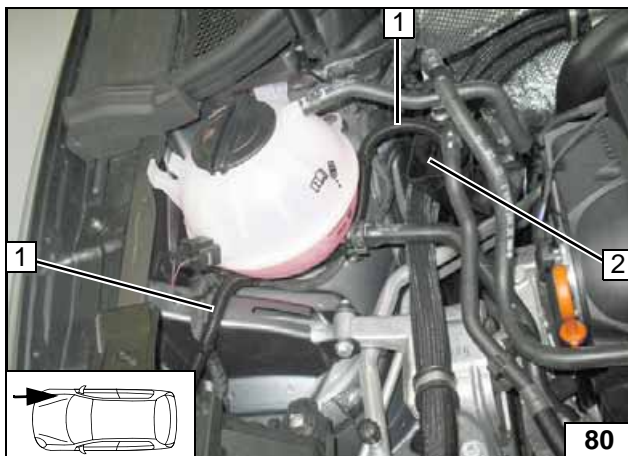

Cut corrugated tube on cable duct **2** to length. Route fuel line and wiring harness of metering pump through cable duct **2** to underbody.

- 1 Fuel line, wiring harness of metering pump in 10mm dia. corrugated tube



**Routing
lines**

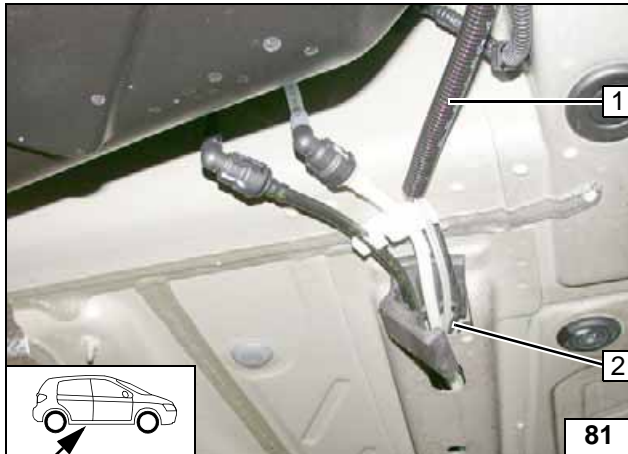

Lead fuel line and wiring harness of metering pump out of cable duct 2 and pull into 10mm dia. corrugated tube 1.



Routing lines

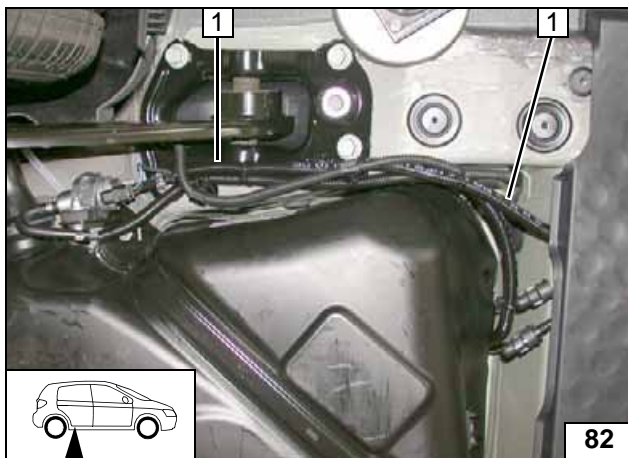

1 Fuel line, wiring harness of metering pump in 10mm dia. corrugated tube



Routing lines

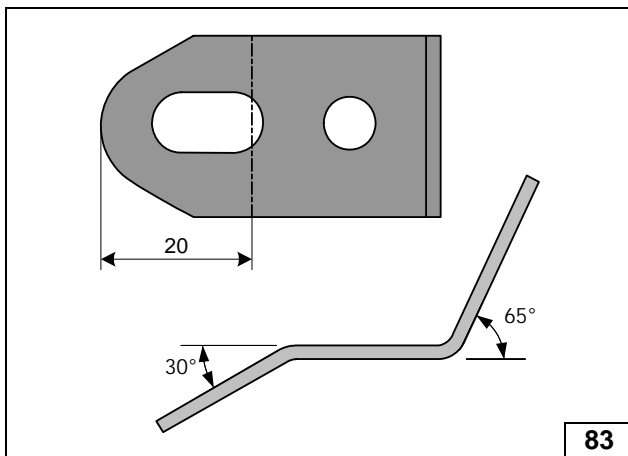

Preparing angle bracket

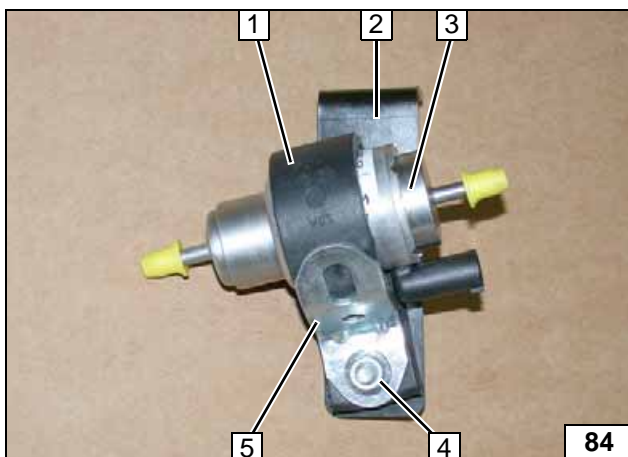

- 1 Metering pump mount
- 2 Metering pump bracket
- 3 Metering pump
- 4 M6x25 bolt, flanged nut
- 5 Angle bracket

Premounting metering pump

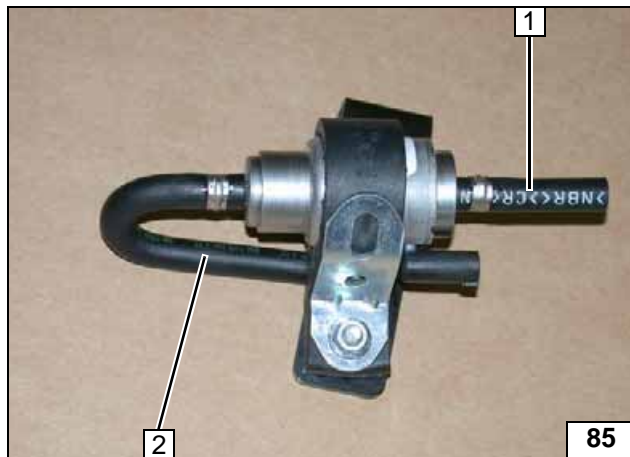

- 1 Hose section, 10mm dia. clamp
- 2 180° moulded hose, 10mm dia. clamp

Premounting metering pump

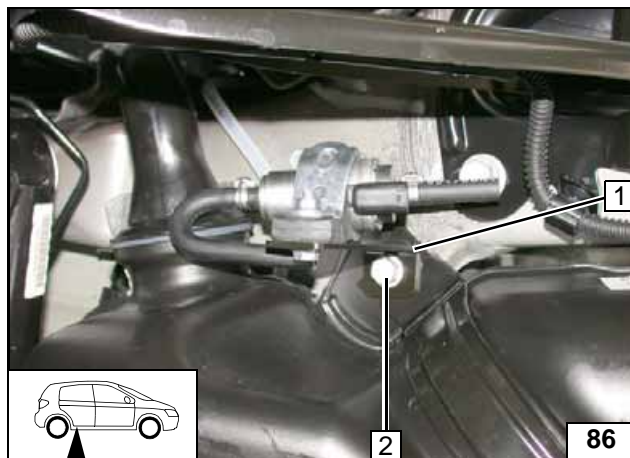

- 1 Metering pump bracket
- 2 Original vehicle bolt



Installing metering pump

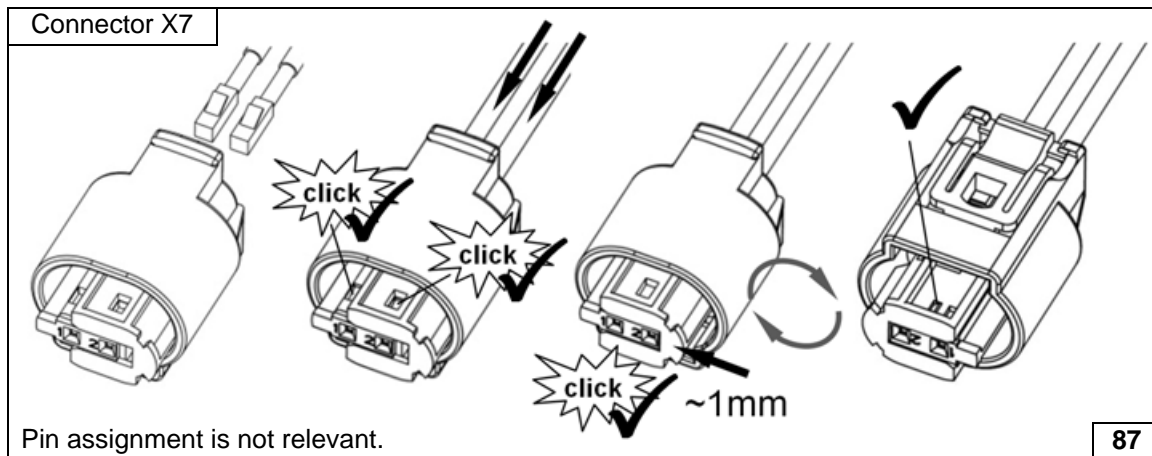

Completing metering pump connector

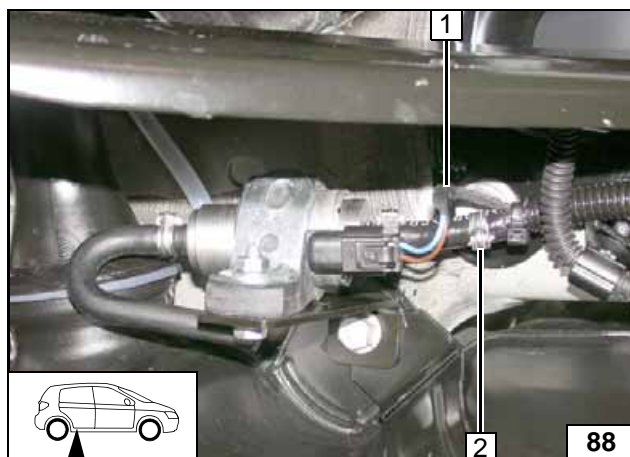

- 1 Wiring harness of metering pump, connector X7 mounted
- 2 Fuel line, 10mm dia. clamp

Connecting metering pump

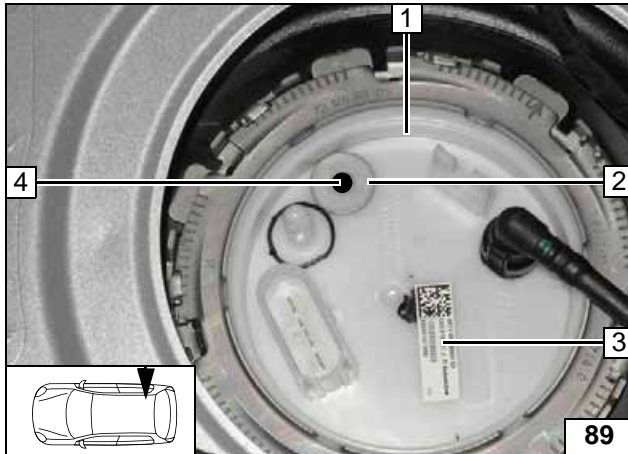
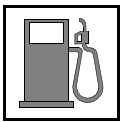

Installing FuelFix

Petrol

Work steps F1, F2 and F3.

Move sticker to position 3.

- 1 Fuel tank sending unit, right side
- 2 Position washer with outer dia. $d_a = 21.6\text{mm}$ as template at the edge and the marked nipple.
- 4 Hole pattern, hole made with provided drill



Copying hole pattern, drilling hole

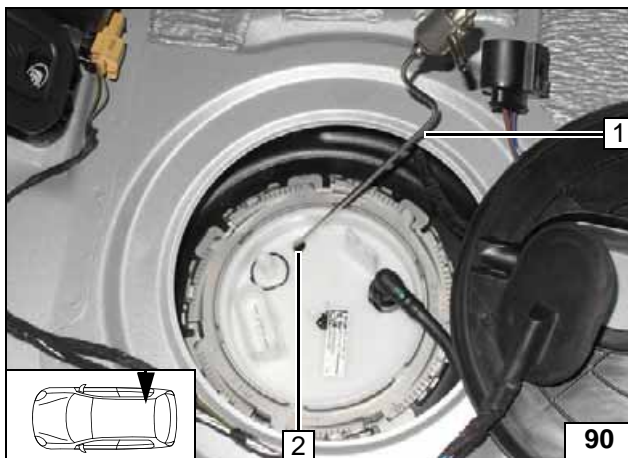

Work steps F4 and F5.

Bend FuelFix 1 according to template and cut to length.
Insert into hole 2.



Inserting FuelFix

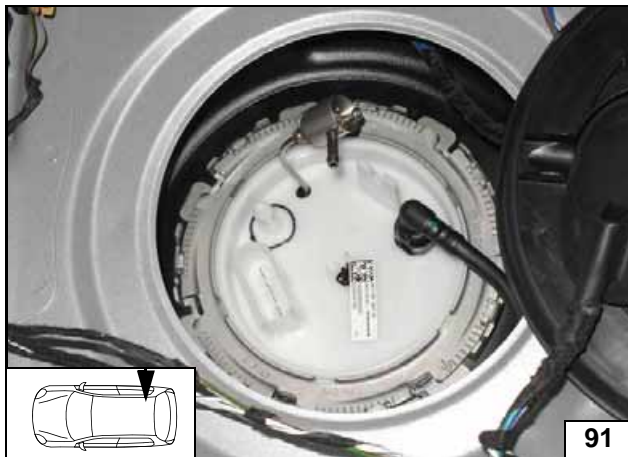

Inserting FuelFix



Inserting FuelFix

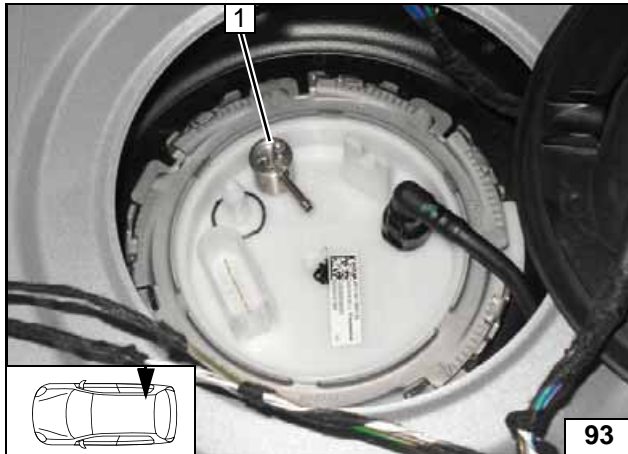
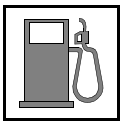

Work steps F5.3 and F5.4.

Position FuelFix 1 as shown.



Aligning FuelFix

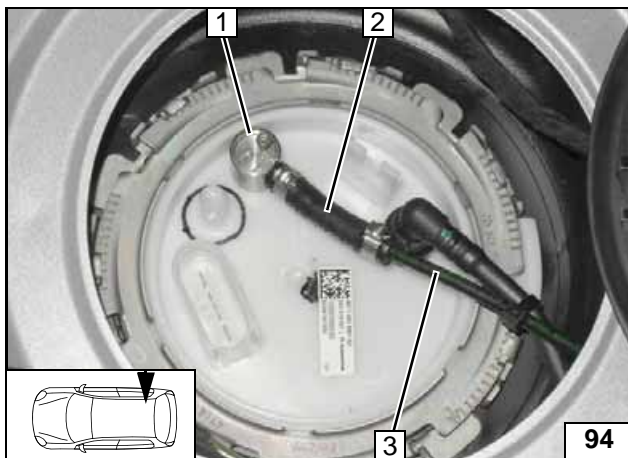

Work step F6.

- 1 FuelFix
- 2 Hose section, 10mm dia. clamp [2x]
- 3 Fuel line

Connecting fuel line

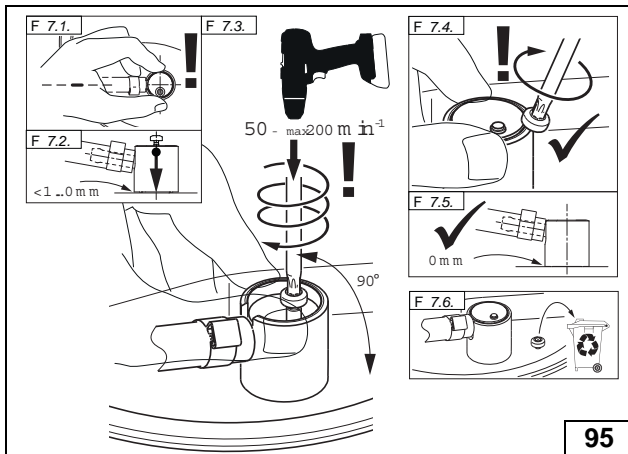

Work step F7.

Installing FuelFix



Work step F8.



Checking firm seating of FuelFix

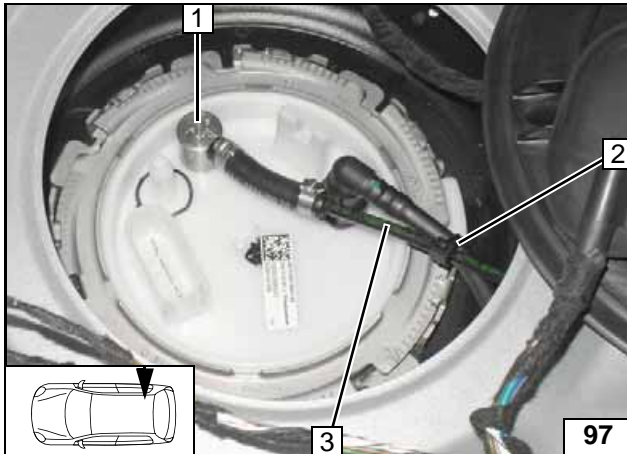
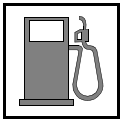

Work step F8.

- 1 FuelFix installed
- 2 Cable tie as tension relief
- 3 Fuel line of FuelFix

Securing fuel line

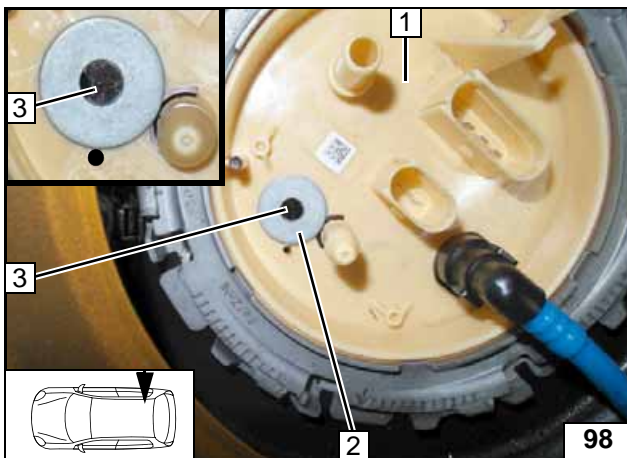

Diesel

Version 1

Work steps F1, F2 and F3.

- 1 Fuel tank sending unit
- 2 Position washer with outer dia. $d_a = 21.6\text{mm}$ as template at the connection piece and the marked nipple
- 3 Hole pattern, hole made with provided drill



Copying hole pattern, drilling hole

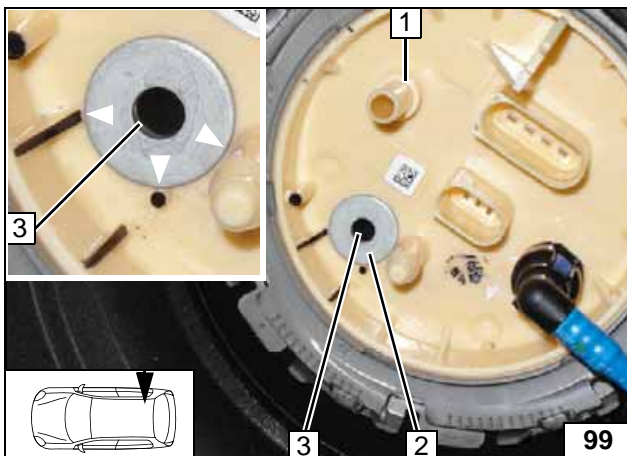

Version 2

Work steps F1 and F2.

- 1 Fuel tank sending unit
- 2 Position washer with outer dia. $d_a = 21.6\text{mm}$ as template at the connection piece, the rib and the marked nipple
- 3 Hole pattern



Copying hole pattern

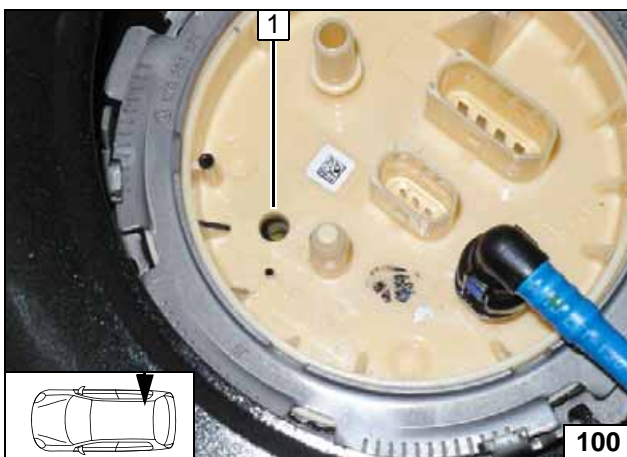

Work step F3.

Drill vertically as far as possible

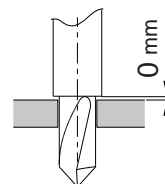

- 1 Hole



Hole for FuelFix

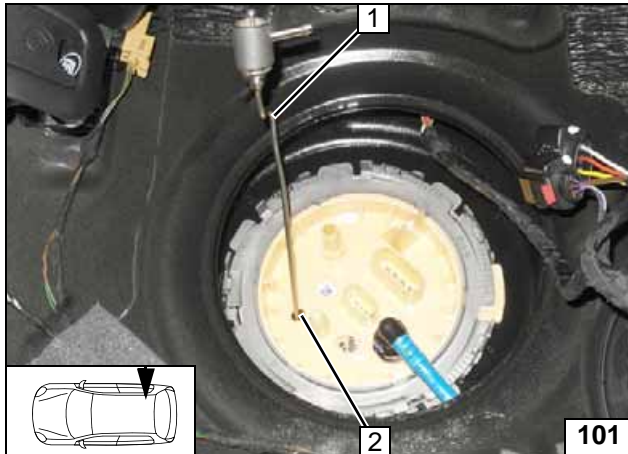

All versions

Work steps F4 and F5.

Bend FuelFix 1 according to template and cut to length.
Insert into hole 2.



Inserting FuelFix



Inserting FuelFix

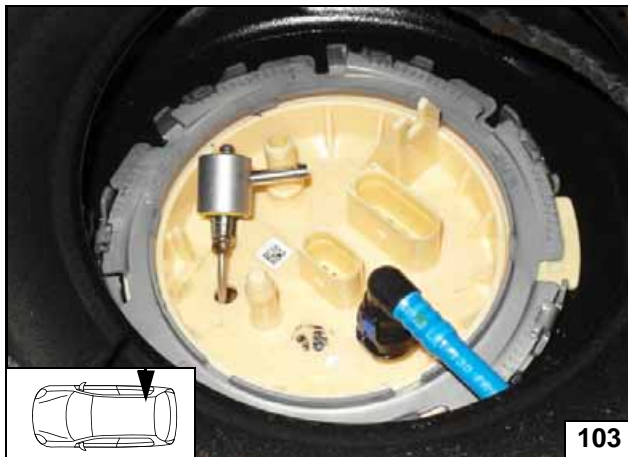

Inserting FuelFix



Work steps F5.3 and F5.4.

Position FuelFix 1 as shown.



Aligning FuelFix

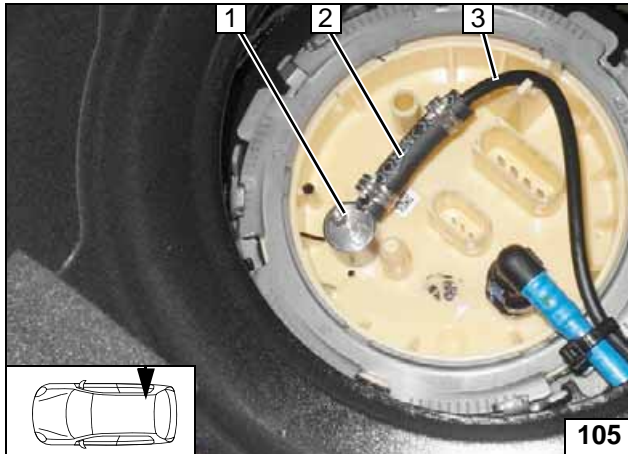

Work step F6.

- 1 FuelFix
- 2 Hose section, 10mm dia. clamp [2x]
- 3 Fuel line

Connect-
ing fuel line

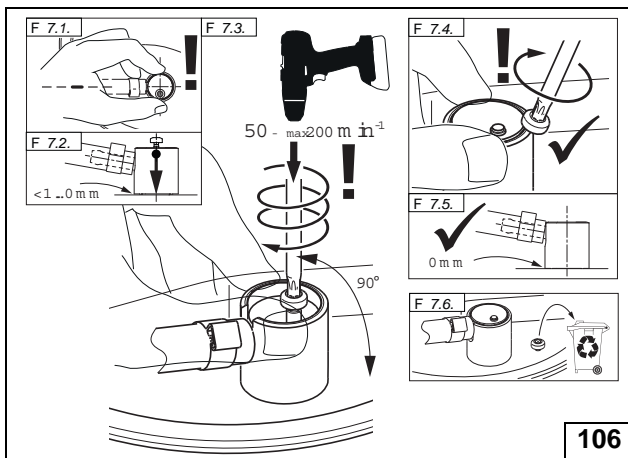

Work step F7.

Installing
FuelFix

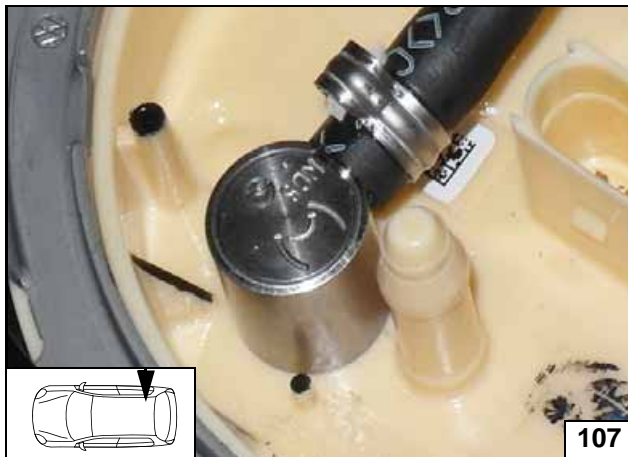

Work step F8.

Checking
firm seating
of FuelFix

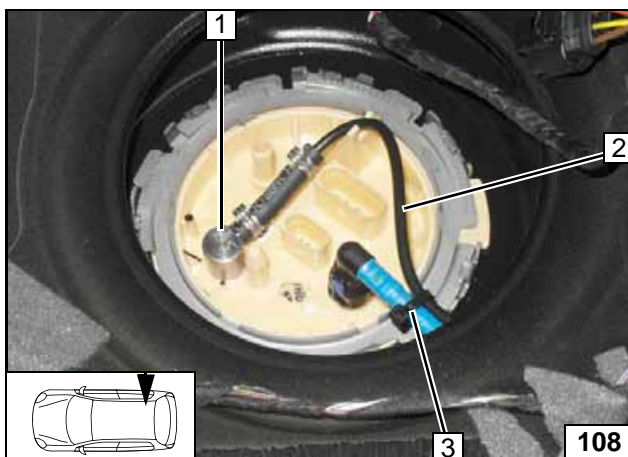

Work step F8.

- 1 FuelFix installed
- 2 Fuel line of FuelFix
- 3 Cable tie as tension relief



Securing
fuel line

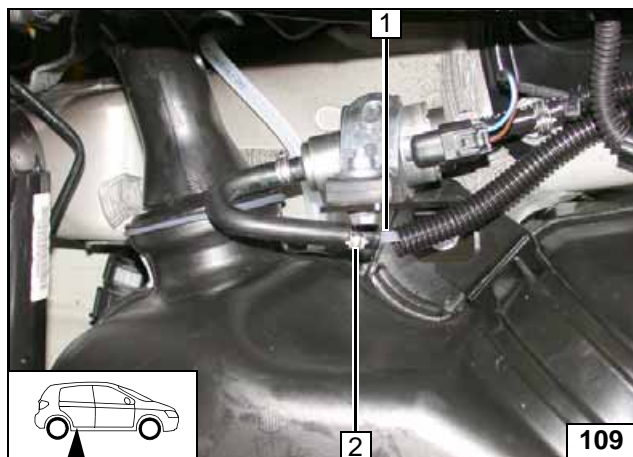

All vehicles

Slide corrugated tube onto fuel line **1**. Check the position of the components; adjust if necessary. Check that they have freedom of movement.

2 10 mm dia. clamp



**Connect-
ing meter-
ing pump**

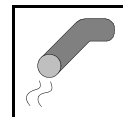

Exhaust Gas

a = 360
b = 210

X =

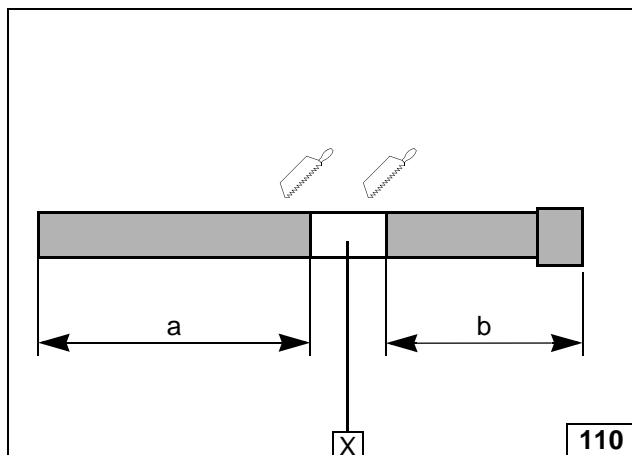

110

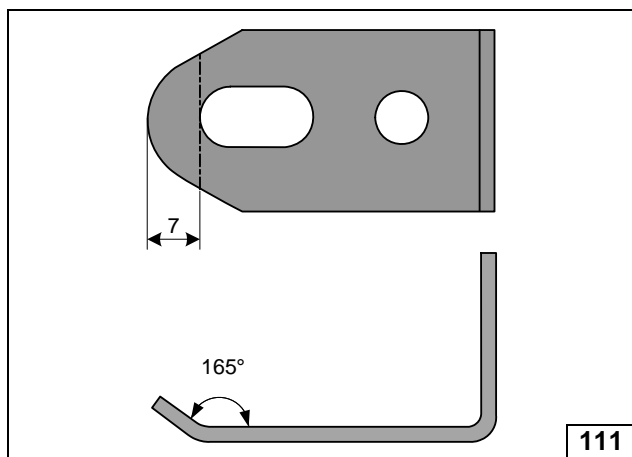

111

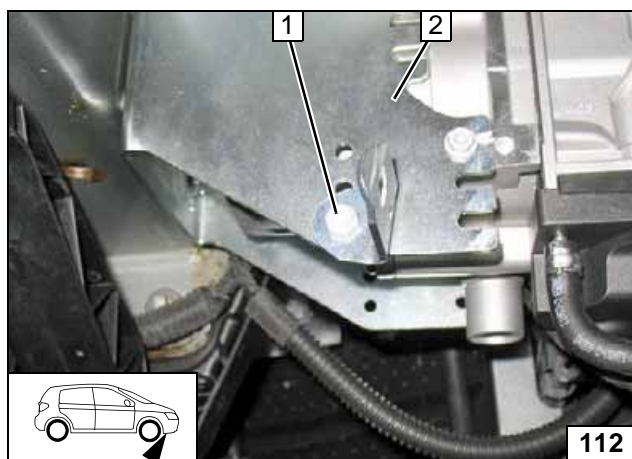

112

- 1 M6x20 bolt, angle bracket, flanged nut
- 2 Heater bracket

Installing angle bracket

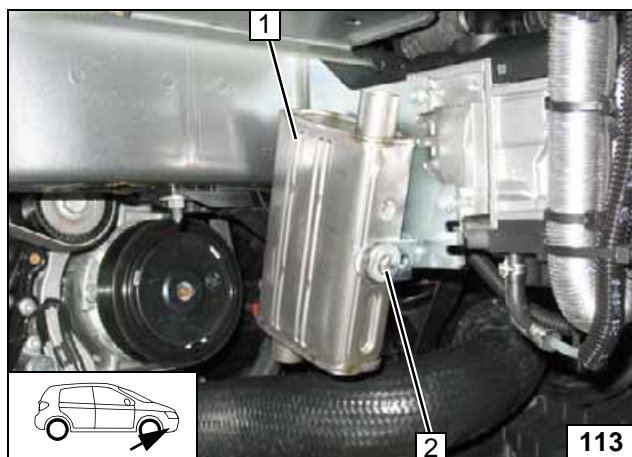

113

- 1 Silencer
- 2 M6x16 bolt, spring lockwasher, large diameter washer

Installing silencer

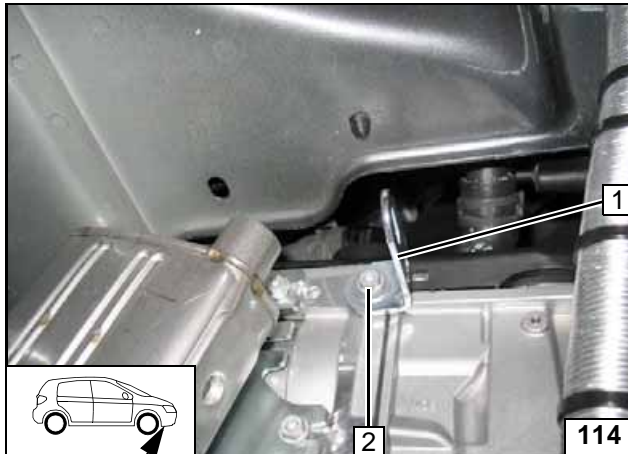
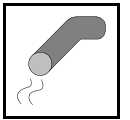

- 1 Angle bracket
- 2 5x13 self-tapping bolt

Installing angle bracket

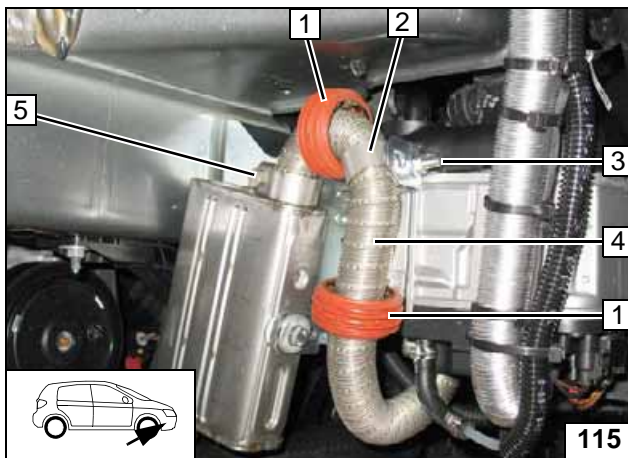

- 1 Push on spacer bracket of flexible tube [2x]
- 2 P-clamp
- 3 M6x20 bolt, flanged nut
- 4 Exhaust pipe
- 5 Hose clamp

Installing exhaust pipe

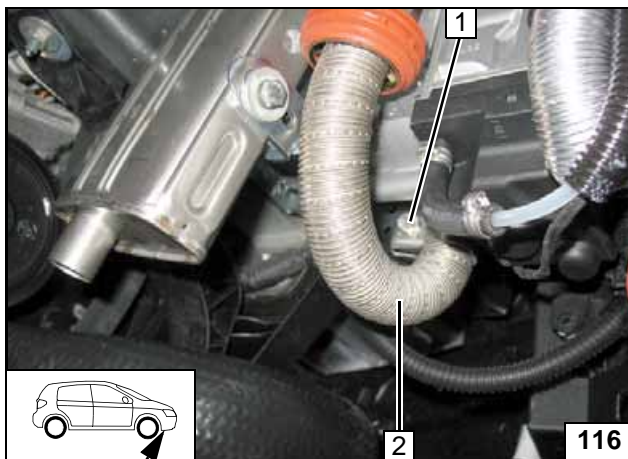

- 1 Hose clamp
- 2 Exhaust pipe

Installing exhaust pipe

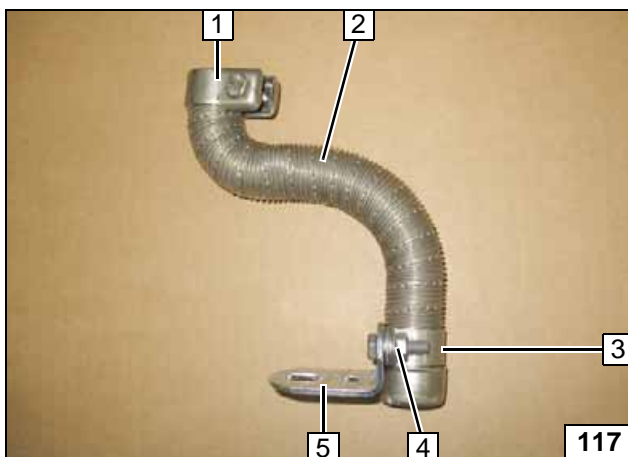

- 1 Mount hose clamp
- 2 Exhaust end section
- 3 P-clamp
- 4 M6x20 bolt, flanged nut
- 5 Angle bracket

Premounting exhaust end section

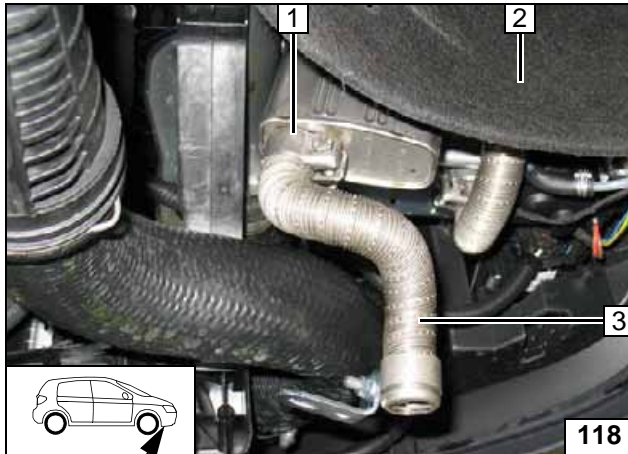
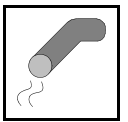

- 1 Tighten hose clamp
- 2 Wheel well trim mounted
- 3 Exhaust end section

Installing exhaust end section

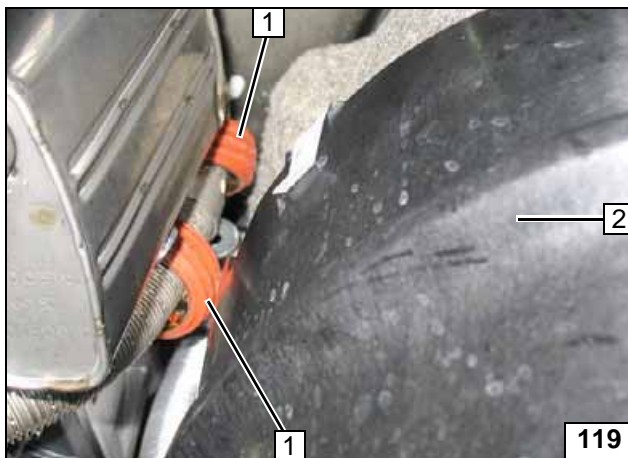

Ensure sufficient distance from neighbouring components.



- 1 Align spacer bracket [2x]
- 2 Wheel well trim

Aligning exhaust pipe

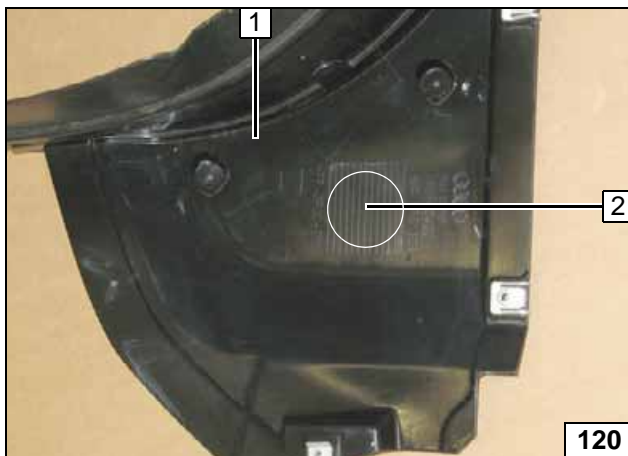

60mm dia. hole 2 in middle of embossing.



- 1 Underride protection

Hole in underride protection

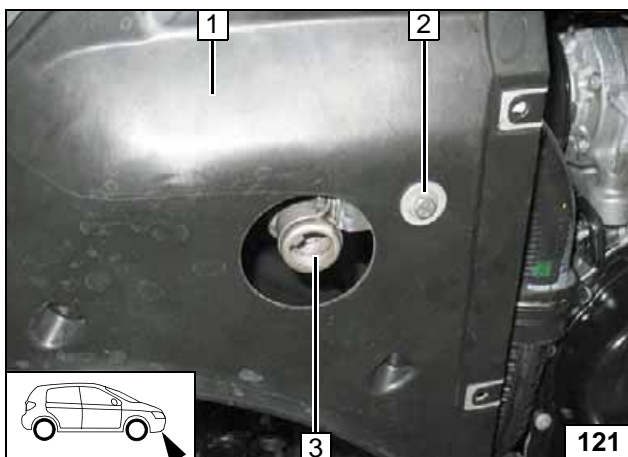

Ensure sufficient distance to neighbouring components.



Centrally align exhaust end section 3 with underride protection hole 1.

- 1 Underride protection mounted
- 2 M6x20 bolt, large diameter washer, flanged nut

Aligning exhaust end section



Final Work



Reassemble the components in reverse order. Check all hoses, clamps and all electrical connections for firm seating. Insulate and tie back all loose lines.

Only use manufacturer-approved coolant. Spray the heater components with anti-corrosion wax (Tectyl 100K).

- **Connect the battery.**
- **Fill and bleed the coolant circuit according to the vehicle manufacturer's specifications.**
- **Program MultiControl CAR, teach Telestart transmitter.**
- **Make settings on A/C control panel according to the 'Operating Instructions for End Customer'.**
- **Place the 'Switch off parking heater before refuelling' caution label near the filler neck.**
- **For initial startup and function check, please see installation instructions.**



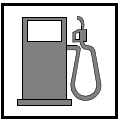

FuelFix Template

Top view

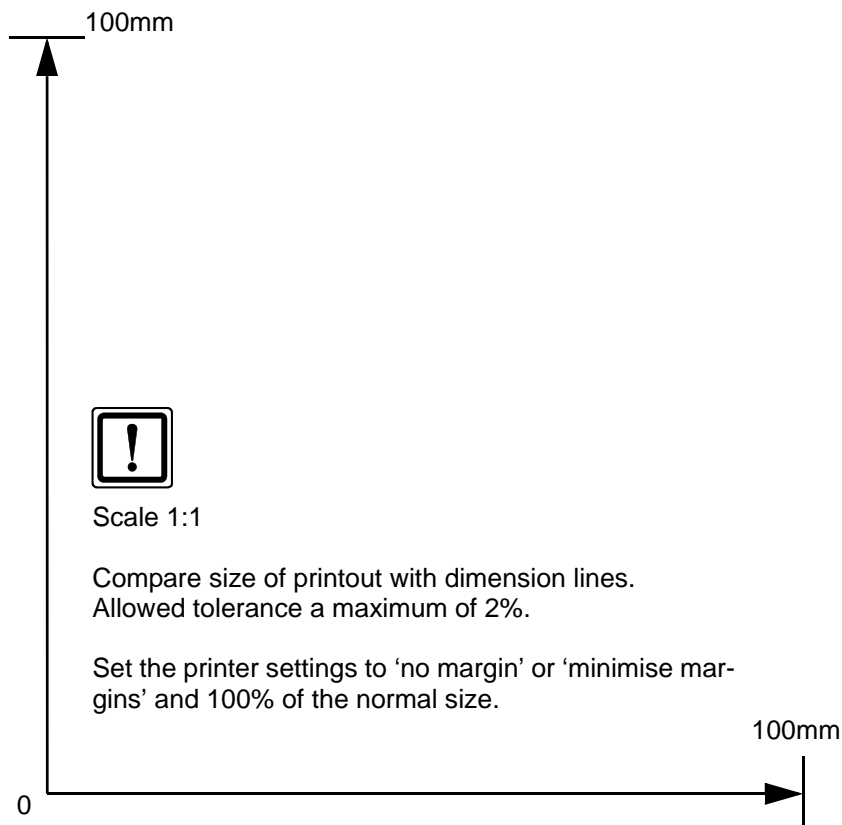
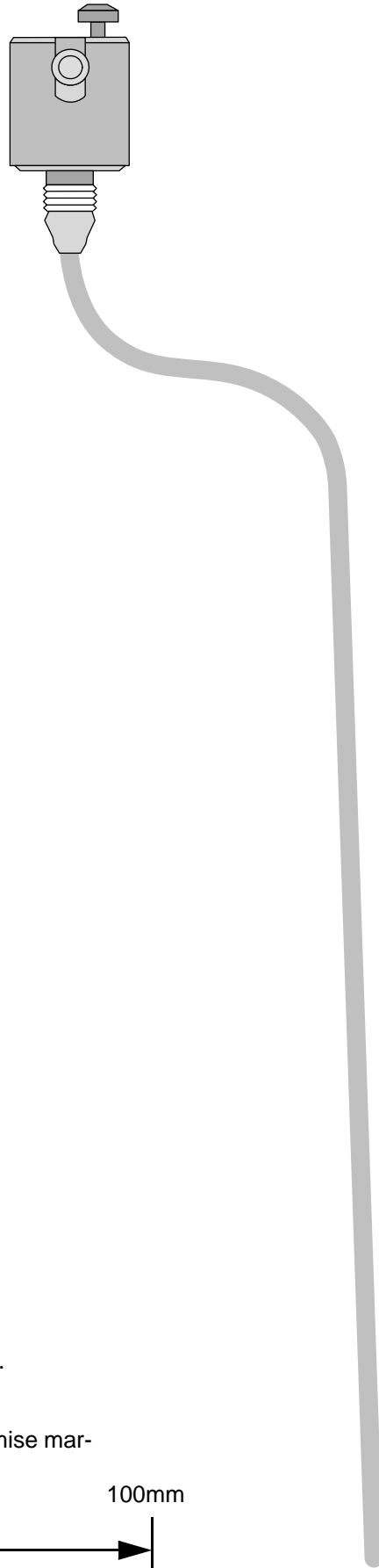
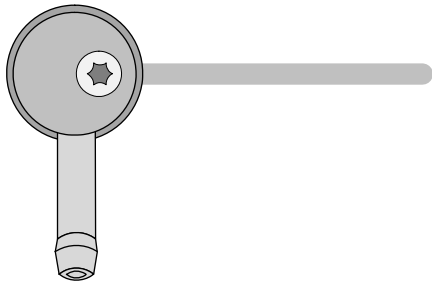

Operating Instructions for Automatic A/C up to MY 2014

Please remove page and add to the vehicle operating instructions.

Note:

We recommend matching the heating time to the driving time.

Heating time = driving time

Example:

For a driving time of approx. 20 min. (in one direction), we recommend not exceeding a switch-on time of 20 min.

Passenger compartment monitoring, if installed, must be deactivated in addition to the vehicle settings for the heating operation.

For instructions on deactivation, please refer to the operating instructions of the vehicle.

Before parking the vehicle, make the following settings:



- 1 Set temperature on both sides to 'HI'
- 2 Air outlet to windscreen

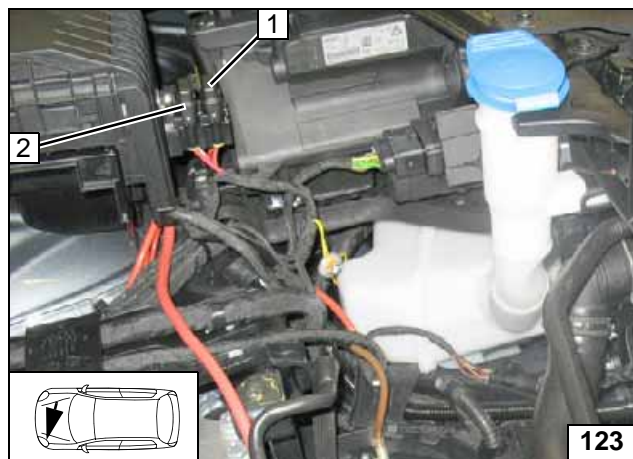

- 1 20A heater fuse F1
- 2 30A main fuse F2 of passenger compartment

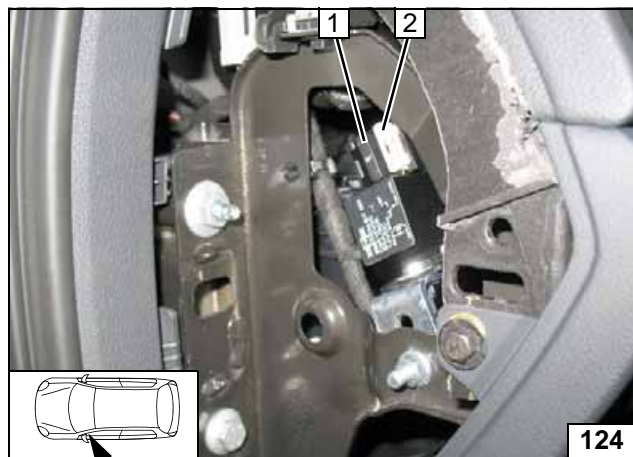

- 1 1A fuse F3 of heater control
- 2 3A fan fuse F4



A/C control panel

Engine compartment fuses

Passenger compartment fuses



Operating Instructions for Automatic A/C from MY 2015

Please remove page and add to the vehicle operating instructions.

Note:

We recommend matching the heating time to the driving time.

Heating time = driving time

Example:

For a driving time of approx. 20 min. (in one direction), we recommend not exceeding a switch-on time of 20 min.

Passenger compartment monitoring, if installed, must be deactivated in addition to the vehicle settings for the heating operation.

For instructions on deactivation, please refer to the operating instructions of the vehicle.

Before parking the vehicle, make the following settings:

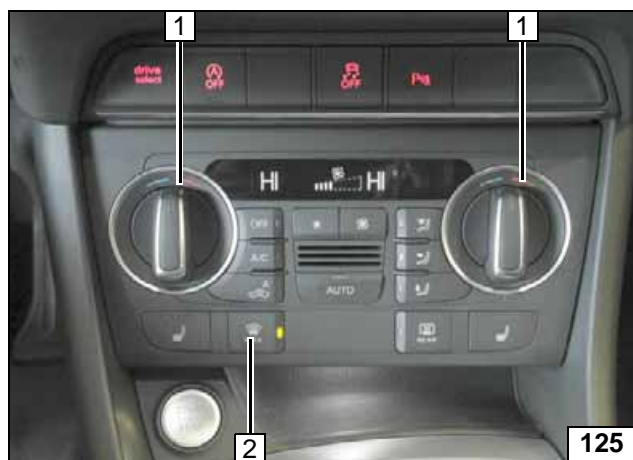

- 1 Set temperature on both sides to 'HI'
- 2 Air outlet to windscreen



A/C control panel

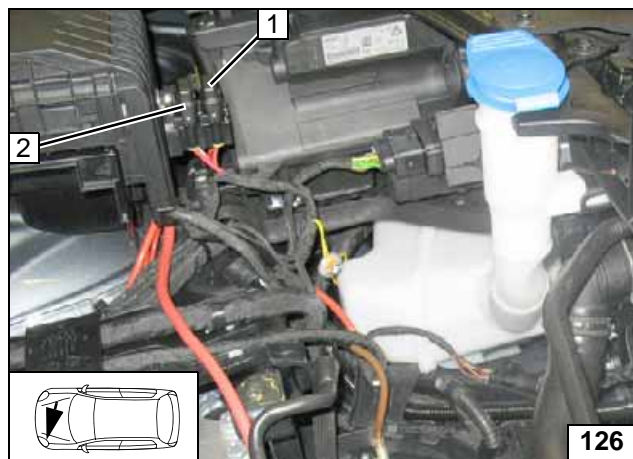

- 1 20A heater fuse F1
- 2 30A main fuse F2 of passenger compartment

Engine compartment fuses

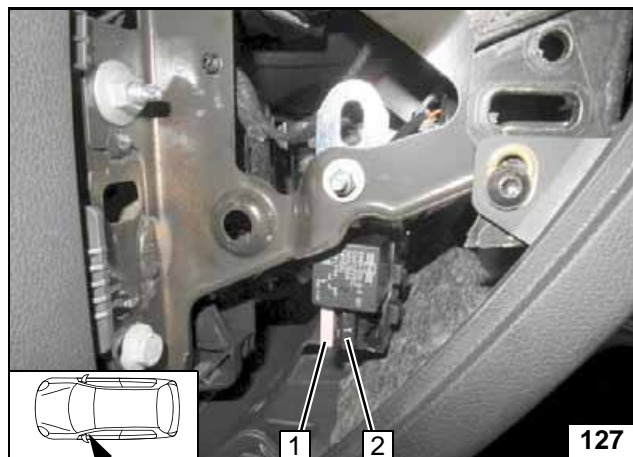

- 1 1A fuse F3 of heater control
- 2 3A fan fuse F4

Passenger compartment fuses

