

Water Heater

Thermo Top E Parking Heater



Thermo Top C Parking Heater



Installation Documentation

Audi A4 / A5

2.7 and 3.0 TDI

Model year 2008 up to 2011

Left-hand drive vehicle

Manual transmission

Comfort-Climatronic



WARNING!

Hazard warning:

The improper installation or repair of Webasto heating and cooling systems can cause fire or the leakage of deadly carbon monoxide, leading to serious injury or death.



To install and repair Webasto heating and cooling systems you need to have completed a special company training course and have the appropriate technical documentation, special tools and special equipment.

Only use genuine Webasto parts. See the Webasto air and water heaters accessories catalogue for this purpose.

NEVER attempt to install or repair Webasto heating or cooling systems if you have not successfully completed the company training and thereby acquired the required technical skills, or if you do not have access to the required technical documentation, tools and equipment needed to carry out correct installation and repairs.

ALWAYS follow all Webasto installation and repair instructions and observe all warnings.

The initial startup is to be executed with the Webasto Thermo Test Diagnosis.

Webasto does not accept any liability for defects and damage that are attributable to installation by untrained staff.

Table of Contents

Validity	2	Remote Option (Telestart)	9
Heater/Installation Kit	3	Preparing Heater	10
Foreword	3	Preparing Installation Location	11
General Instructions	3	Installing Heater	13
Special Tools	3	Coolant Circuit	15
Explanatory Notes on Document	4	Fuel	20
Preliminary Work	5	Exhaust Gas	24
Heater Installation Location	5	Final Work	25
Electrical System	6	Coding of Control Unit of Climatronic J255	25
Fan Controller	7	Operating Instructions for End Customer	26
Digital Timer, Summer/Winter Switch Option	9		

Validity

Manufacturer	Model	Type	EG-BE No./ABE
Audi	A4	B8	e1 * 2001 / 116 * 0430 * ...
Audi	A5	B8	e1 * 2001 / 116 * 0430 * ...

Engine type	Engine model	Output in kW	Displacement in cm ³
CAMA	Diesel	140	2698
CAPA	Diesel	176	2967

Vehicle and engine types, equipment variants and national specifications not listed in this installation documentation have not been tested. However, installation according to this installation documentation may be possible.

The installation location of the digital timer should be confirmed with the end customer before installation.

Heater/Installation Kit

Quantity	Description	Order No.:
1	Basic delivery scope for <i>Thermo Top E / C</i>	See price list
1	Installation Kit for Audi A4 /A5 2.7 + 3.0 TDI Manual Transmission	1313499B
1	Heater control	See price list

Foreword

This installation documentation applies to the vehicles Audi A4 / A5 2.7 and 3.0 TDI - for validity, see page 2 - model year 2008 up to 2011, assuming technical modifications to the vehicle do not affect installation, any liability claims excluded. Depending on the vehicle version and equipment, modifications may be necessary during installation with respect to this installation documentation.

However, the stipulations in the "installation documentation", the "operating instructions" and "installation instructions" for the *Thermo Top E / C* must always be observed.

The corresponding rules of technology and any information from the vehicle manufacturer should be observed during the installation work.

General Instructions

Installation should be carried out according to the general, standard rules of technology. Unless specified otherwise, fasten hoses, lines and wiring harnesses to original vehicle lines and wiring harnesses using cable ties. Insulate loose wires and tie back!

Sharp edges should be fitted with rub protection (split-open fuel hose).

Spray unfinished body areas, e.g. drilled holes, with anti-corrosion wax (Tectyl 100K, Order No. 111329).

When installing an IPCU, the appropriate settings must be checked and set prior to the installation.

Special Tools

- Torque wrench for 2.0 - 10 Nm
- Hose clamping pliers
- 2.0mm dia. drill
- Metric thread-setter kit
- VAS tester (coding of Climatronic control unit)

Explanatory Notes on Document

You will find an identification mark on the outside top right corner of the page in question to provide you with a quick overview of the individual working steps.

Mechanical system

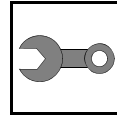

Electrical system

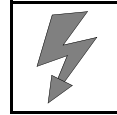

Coolant circuit

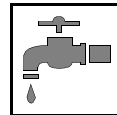

Fuel

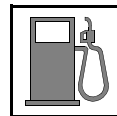

Exhaust gas

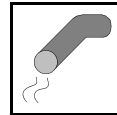

Combustion air

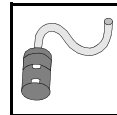

Software

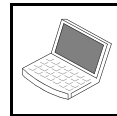

Special features are highlighted using the following symbols:



Specific risk of injury or fatal accidents.



Specific risk of damage to components.



Specific risk of fire or explosion.



Reference to general installation instructions of Webasto components or to the manufacturer's vehicle-specific documents.



Reference to a special technical feature.

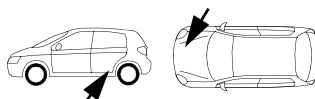

The arrow in the vehicle icon indicates the position on the vehicle and the viewing angle.

All dimensions are in mm!
Tightening torque of hose clamps = 2.0 + 0.5 Nm!
Tightening torque of Ejet screws, Ejet studs = 10 Nm!

Preliminary Work

WARNING!

- Open the fuel tank cap, ventilate the tank.
- Close the fuel tank cap again.
- Disconnect the battery "earth" or "ground" connection.
- Depressurise the cooling system.
- Copy the factory number from the original type label to the duplicate type label.
- Remove years that do not apply from the duplicate label.
- Attach the duplicate label (type label) in the appropriate place.
- Remove the coolant reservoir cap.
- Removing the filler neck of the washer fluid reservoir.
- Remove the cover of the fuse and relay box.
- Pull out the control unit and lay it aside.
- Detach and fold back the front right wheel well trim.
- Remove the engine underdrive protection.
- Remove the 3-piece underbody cover.
- Remove the rear bench seat.
- Open the right-hand tank-fitting service lid.
- Remove the A/C control panel in accordance with the manufacturer's instructions.
- Remove the lower instrument panel trim on the driver's side.

Remove page 26 "Operating Instructions for End Customer" and add to the vehicle operating instructions.

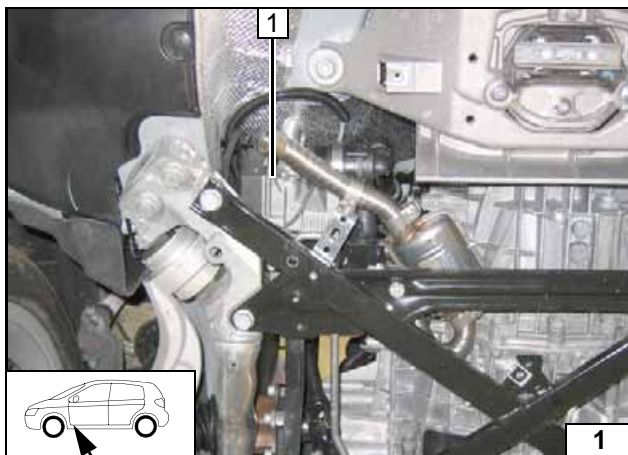

Heater Installation Location

1 Heater

Installation location



Electrical System

Fuse holder, K3 relay

- 1 Positive wire on positive support point
- 2 4 mm dia. hole, 5.5x13 self-tapping screw; spring lockwasher, angle bracket (with existing hole, M6x20 bolt, spring lockwasher, flanged nut)
- 3 M5x16 bolt, washer, K3 relay, flanged nut
- 4 M5x16 bolt, washer, retaining plate for fuse holder, flanged nut

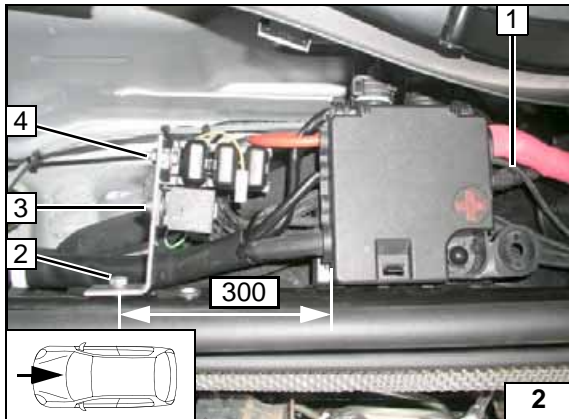

Digital timer, summer/winter switch option

- 1 Summer/winter switch, drilled hole 12 mm dia.
- 2 Digital timer

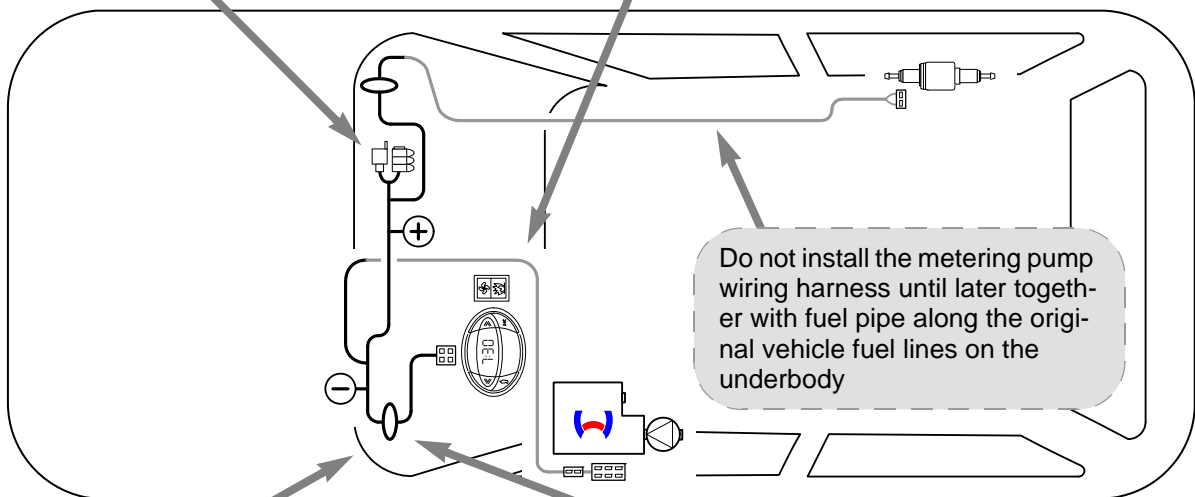
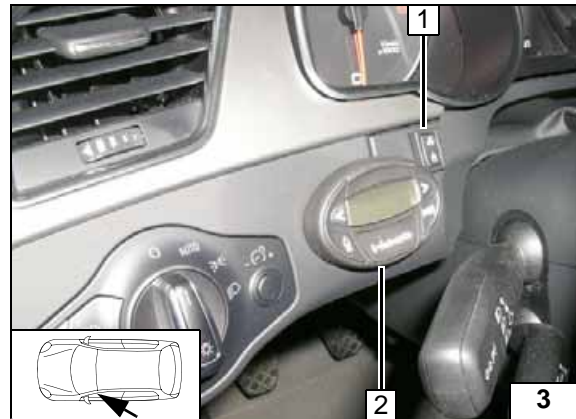

Wiring harness routing diagram

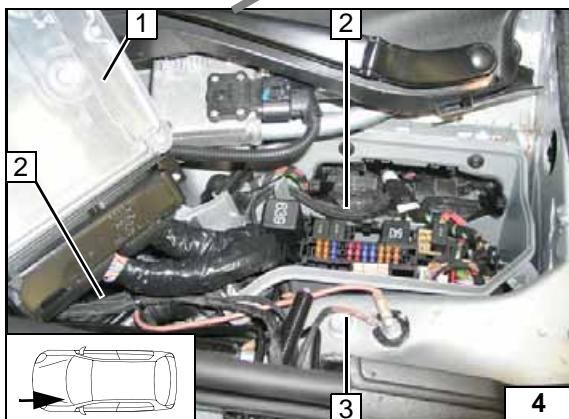

Wiring harness pass through

- 1 Control unit pulled out
- 2 Wiring harness of fan controller, digital timer
- 3 Earth wire on earth support point

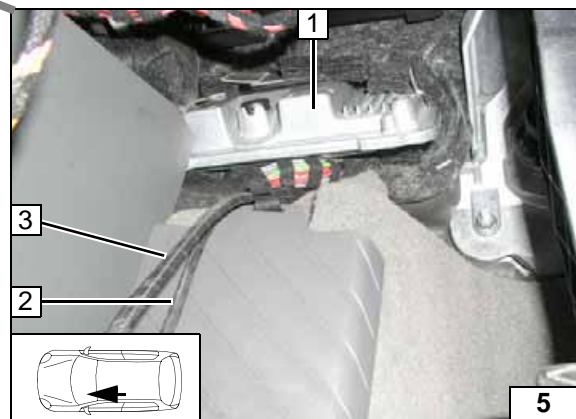

Wiring harness pass through

- 1 Control unit mounted again
- 2 Wiring harness of digital timer
- 3 Wiring harness of fan controller



Fan Controller

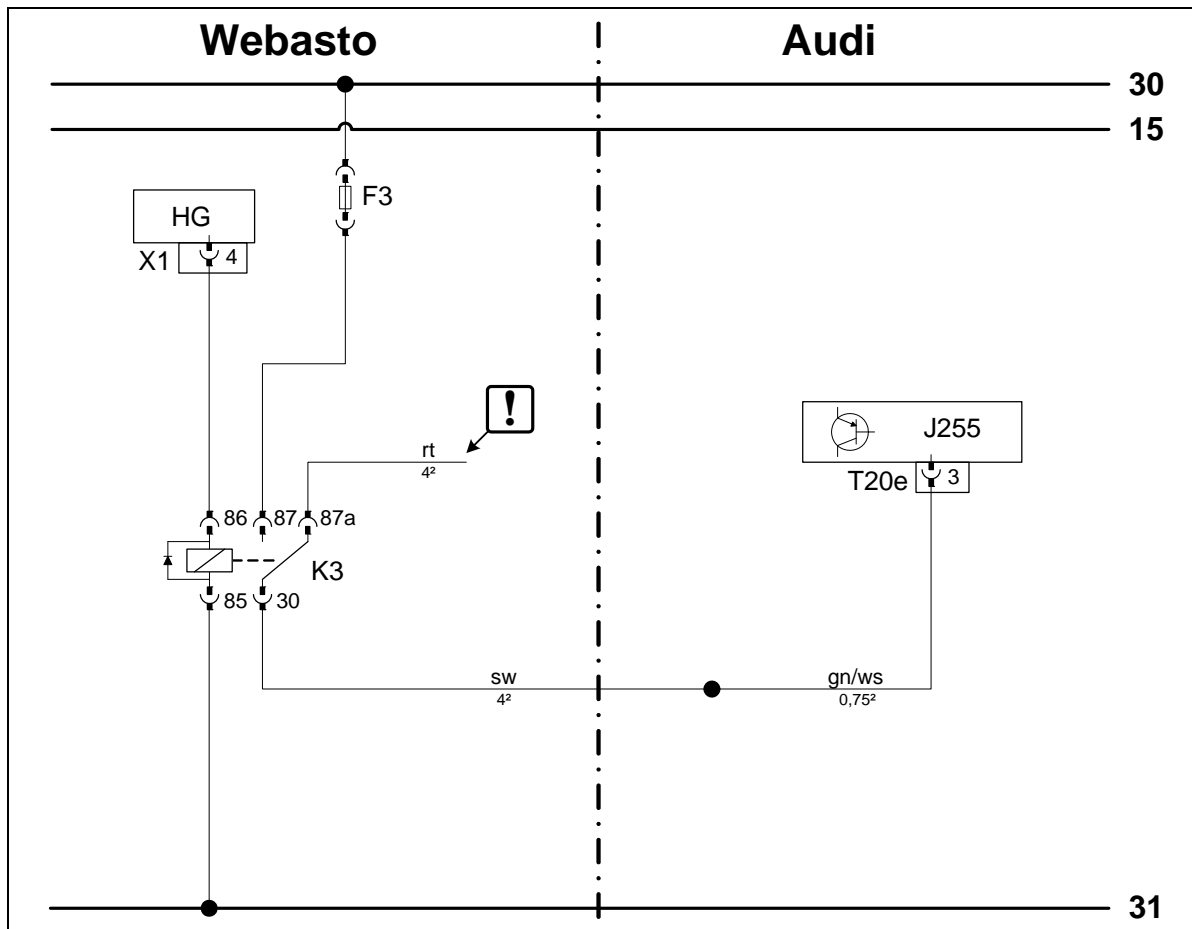

Wiring diagram

Webasto components		Vehicle components		Colours and symbols	
HG	Heater TT-C/E	J255	Air-conditioning control panel	rt	red
X1	6-pin heater connector	T20e	20-pin connector J255	ws	white
F3	Replace 25 A with 1 A fuse.			sw	black
K3	Fan relay			gn	green
					Insulate wire ends and tie back
				X	Cutting point
					Wiring colours may vary.

Legend

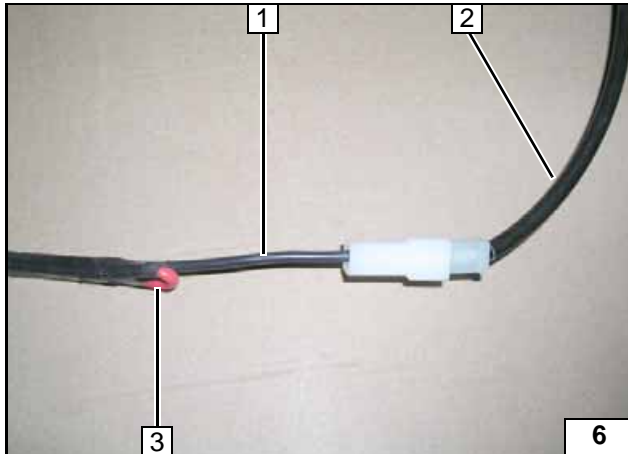

Produce connections as shown in wiring diagram.

- 1 Black (sw) wire from K3/30
- 2 Green/white (gn/ws) additional wire in protective sleeving
- 3 Insulate red (rt) wire K3/87a and tie back



Preparing fan wiring harness

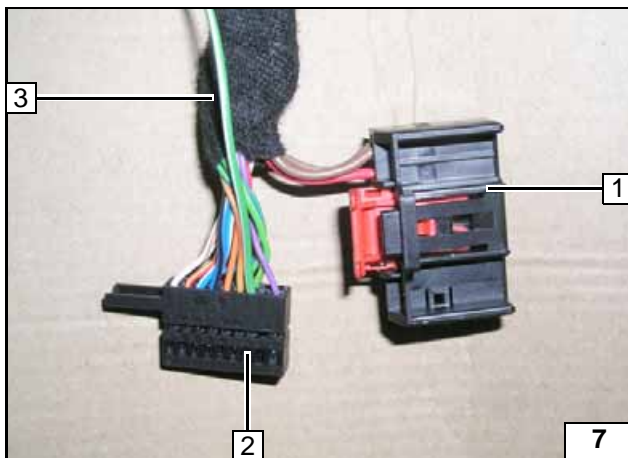

Connection to 20-pin connector T20e 1 from A/C control panel.
Produce connections as shown in wiring diagram.

- 1 Remove connector T20e of A/C control panel
- 2 Free socket, PIN 3
- 3 Green/white (gn/ws) additional line



Connecting A/C control panel

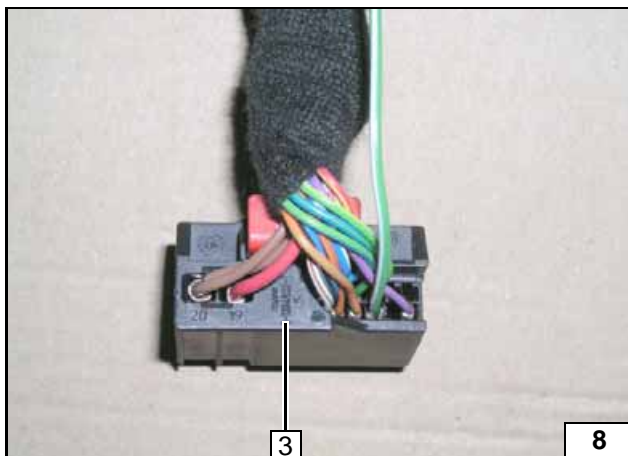

- 1 Complete 20-pin connector of A/C control panel

Reinserting connector



Digital Timer, Summer/Winter Switch Option

- 1 Summer/winter switch, drilled hole 12 mm dia.
- 2 Digital timer

Installing digital timer

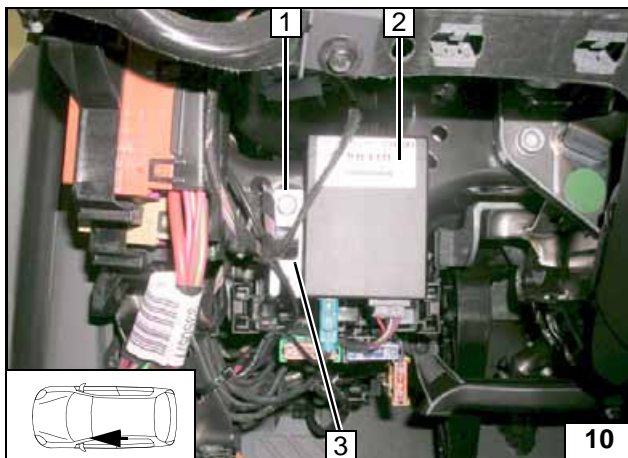

Remote Option (Telestart)

Drill out bracket 3 to 6.5mm dia. at position 1.

- 1 M6x20 bolt, spring lockwasher on existing threaded hole
- 2 Receiver



Installing receiver

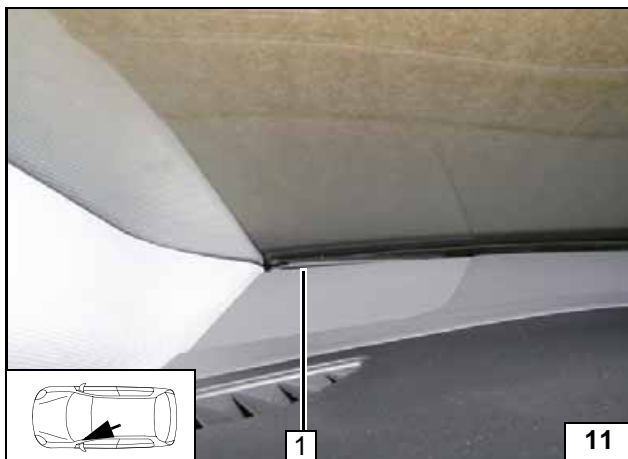

- 1 Antenna

Installing antenna

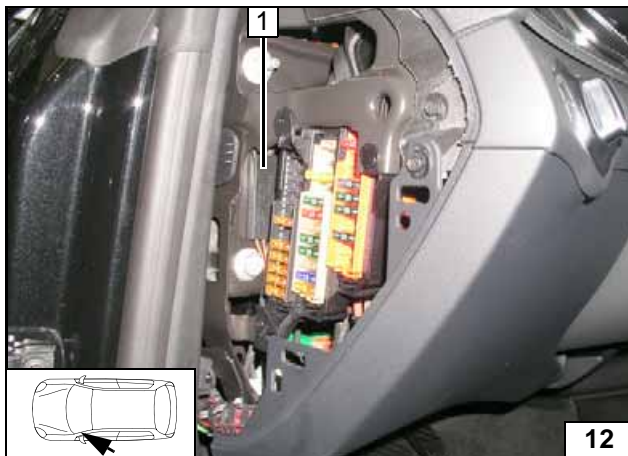

Temperature sensor for HTM100 only

- 1 Fasten temperature sensor with adhesive tape



Installing temperature sensor

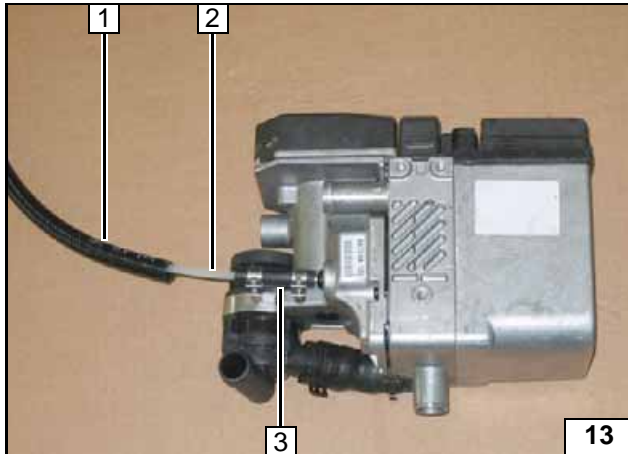
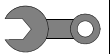

Preparing Heater

- 1 Slide corrugated tube onto fuel line
- 2 Fuel line
- 3 Hose section, 10 mm dia. clamp [2x]

Premounting fuel hose on heater

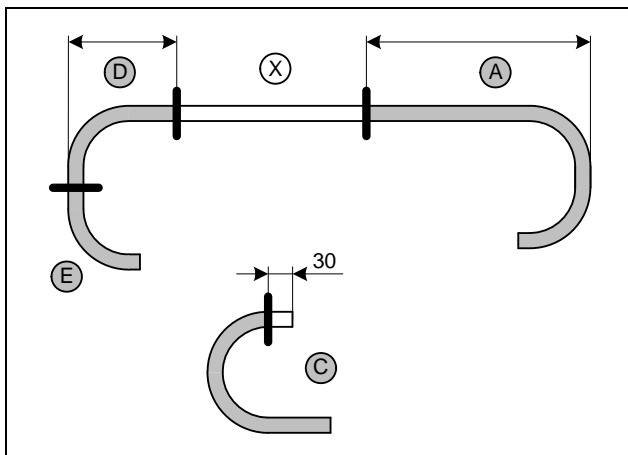

Shorten hose **C** = 180° moulded hose. Cut heat protection hose to 900 mm and slide onto hose **A**.

- A** = 980
- D** = 100

Discard section **X**.



Cutting coolant hose 1 to length

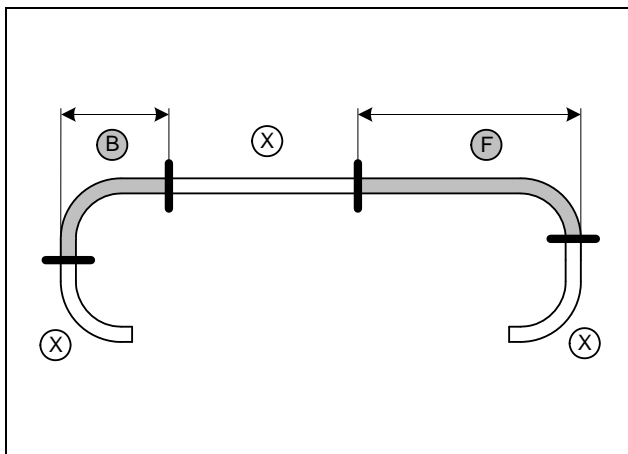

Cut away hose **F** shortly before the elbow. Cut heat protection hose to 950 mm and slide onto hose **F**.

- B** = 115
- F** = 1025

Discard section **X**.



Cutting coolant hose 2 to length

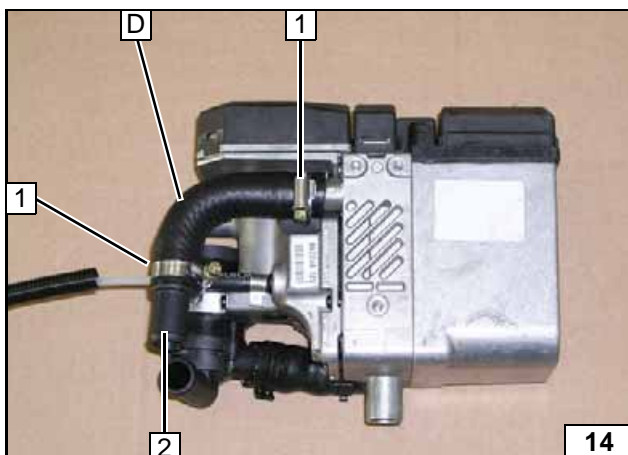

- 1 27 mm dia. clamp [2x]
- 2 20x20 connecting pipe

Premounting hose D

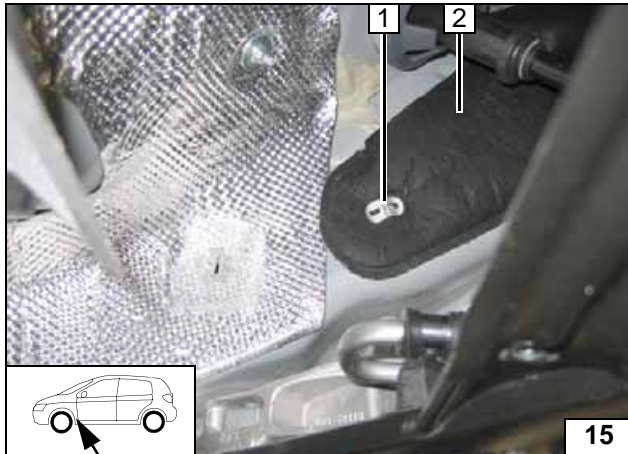
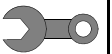

Preparing Installation Location

Remove retaining clip **1**. Lay aside insulation/heat protection mat **2** (if installed).



Removing retaining clip

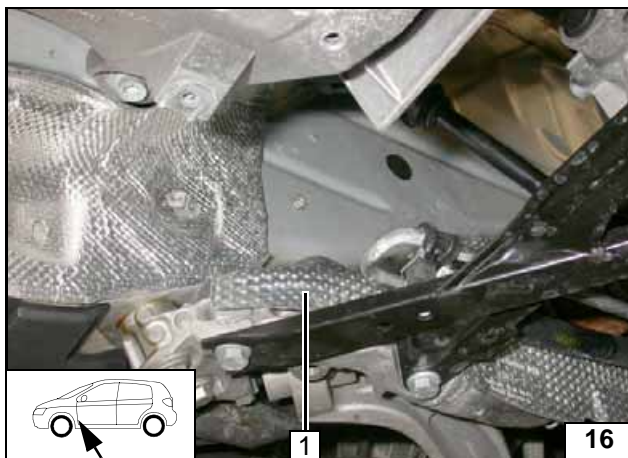

Remove guard plate **1** (if installed).



Removing guard plate

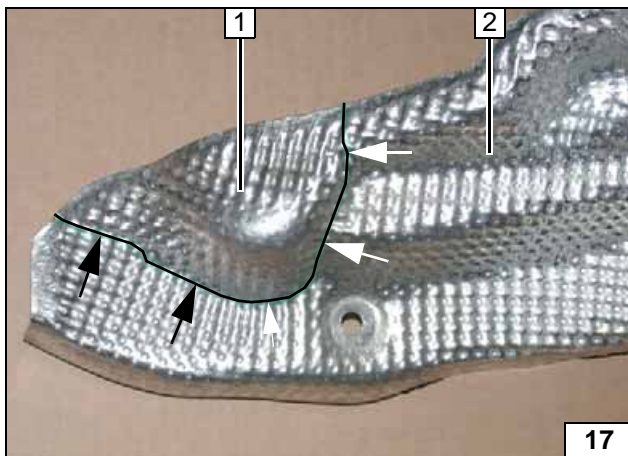

Cut out guard plate **2** at marking. Discard section **1**.



Cutting out guard plate

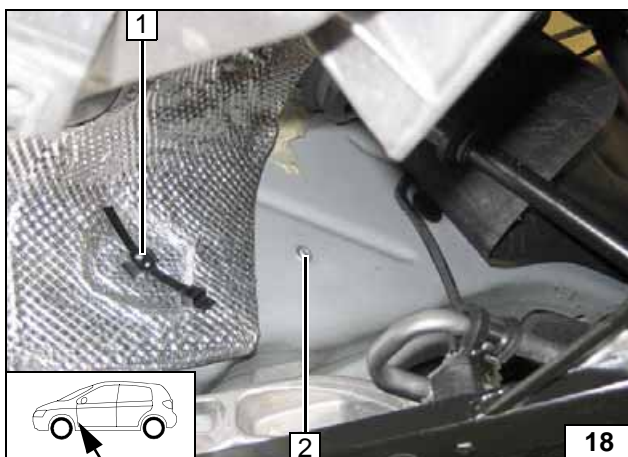

Remove retaining clip at position **1** and install clip-type cable tie.



2 Drill 9.1 mm dia. hole; install rivet nut

Installing rivet nut

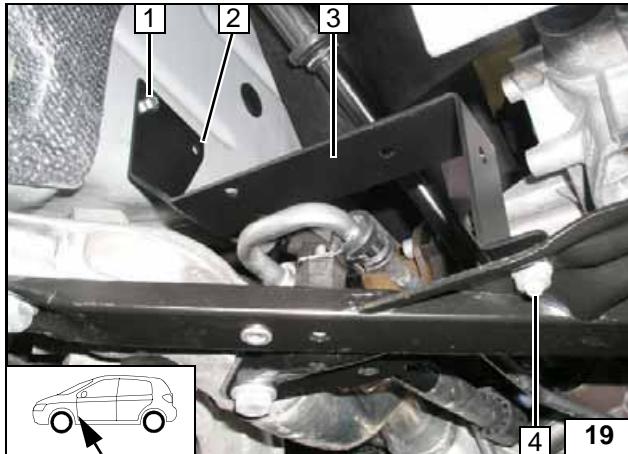
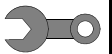

- 1 M6x30 screw, spring lockwasher on rivet nut
- 2 Copy hole pattern
- 3 Bracket
- 4 M8x20 bolt, M8 nut on existing hole

Copying hole pattern

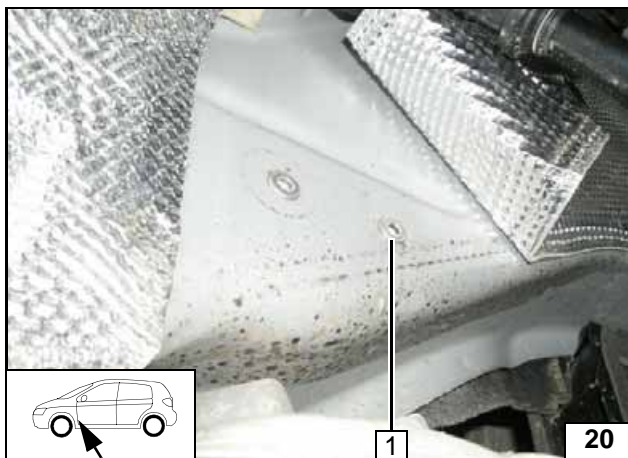

Remove bracket.

- 1 Drill 9.1 mm dia. hole; install rivet nut



Installing rivet nut

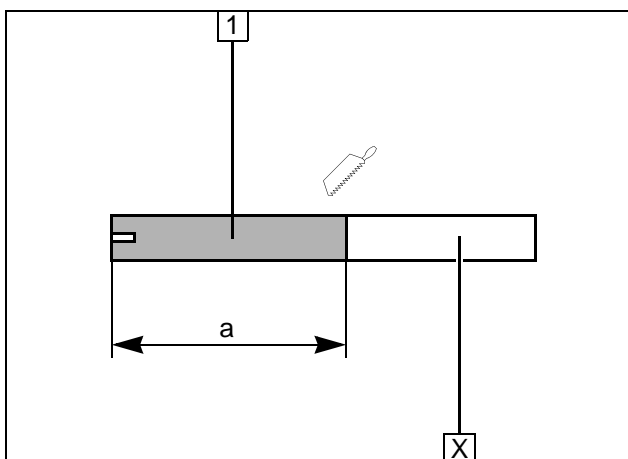

- 1 Combustion air pipe
a = 220

Discard section X.

Cutting combustion air pipe to length

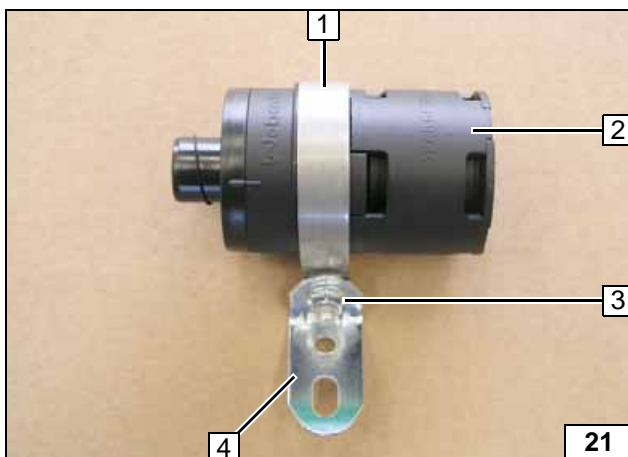

- 1 52 mm dia. p-clamp
- 2 Combustion air silencer
- 3 M6x20 bolt, flanged nut on angle bracket
- 4 Angle bracket



Pre-mounting combustion air silencer

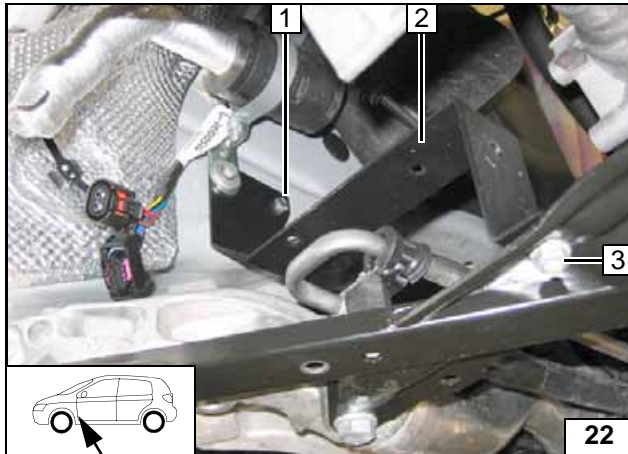
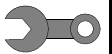

- 1 M6x30 screw, spring lockwasher on rivet nut
- 2 Bracket
- 3 M8x20 bolt, M8 nut on existing hole

Installing bracket

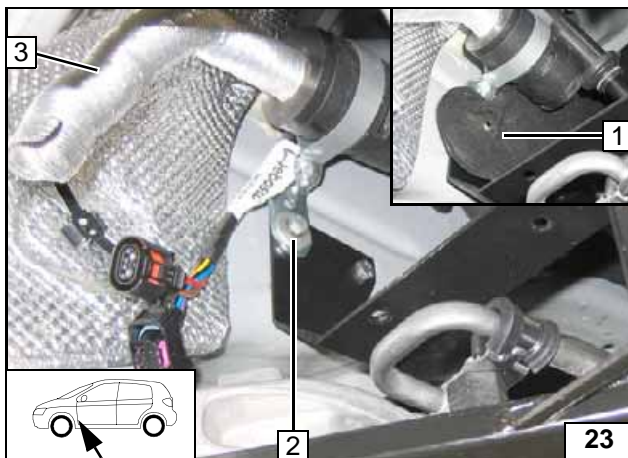

Fold back insulating/heat protection mat 1 after installing.



- 2 M6x30 bolt, spring lockwasher, large diameter washer, angle bracket on rivet nut
- 3 Combustion air pipe

Installing combustion air silencer

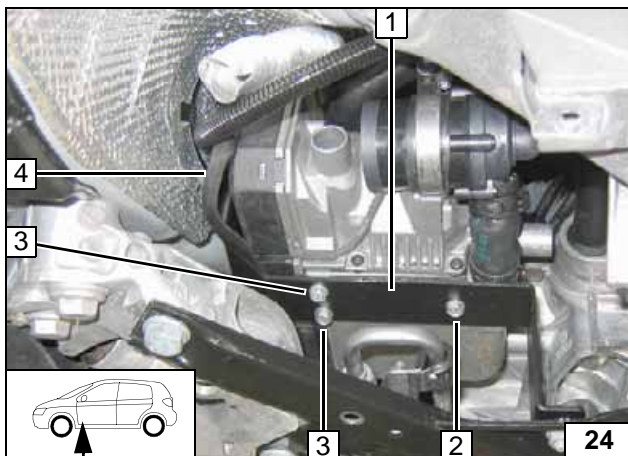

Installing Heater

Before installing, connect wiring harness 4 on heater. Insert two washers between heater and bracket 1 at position 2.



- 2 E-jot screw, washer [2x]
- 3 E-jot screw [2x]

Installing heater

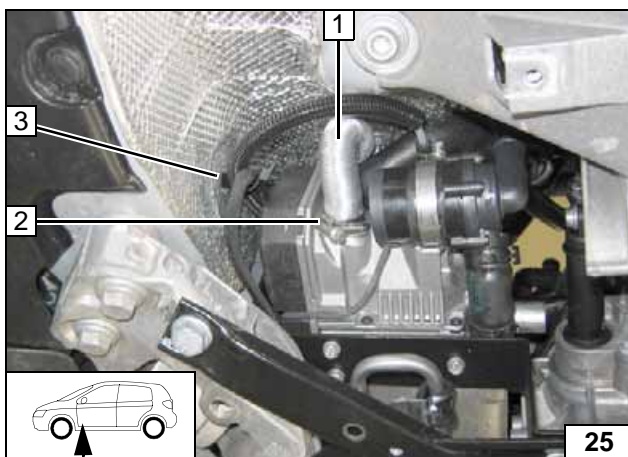

Secure fuel line in corrugated tube and wiring harness of heater with clip-type cable tie 3. Ensure sufficient distance to neighbouring components.



- 1 Combustion air pipe
- 2 Clamp

Connecting combustion air pipe

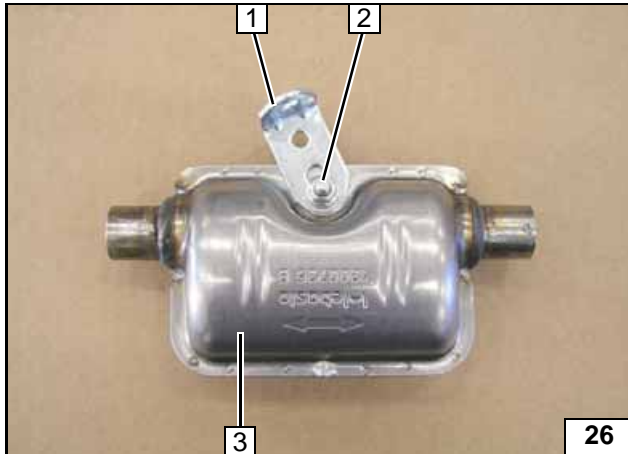
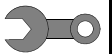

- 1 Angle bracket
- 2 M6x20 bolt, flanged nut
- 3 Silencer

Premounting silencer

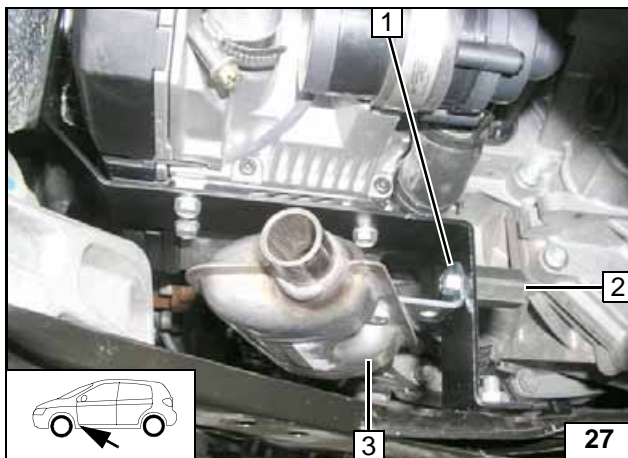

- 1 M6x16 bolt
- 2 30 mm dia. spacer nut
- 3 Preassembled silencer

Installing silencer





Coolant Circuit

WARNING!

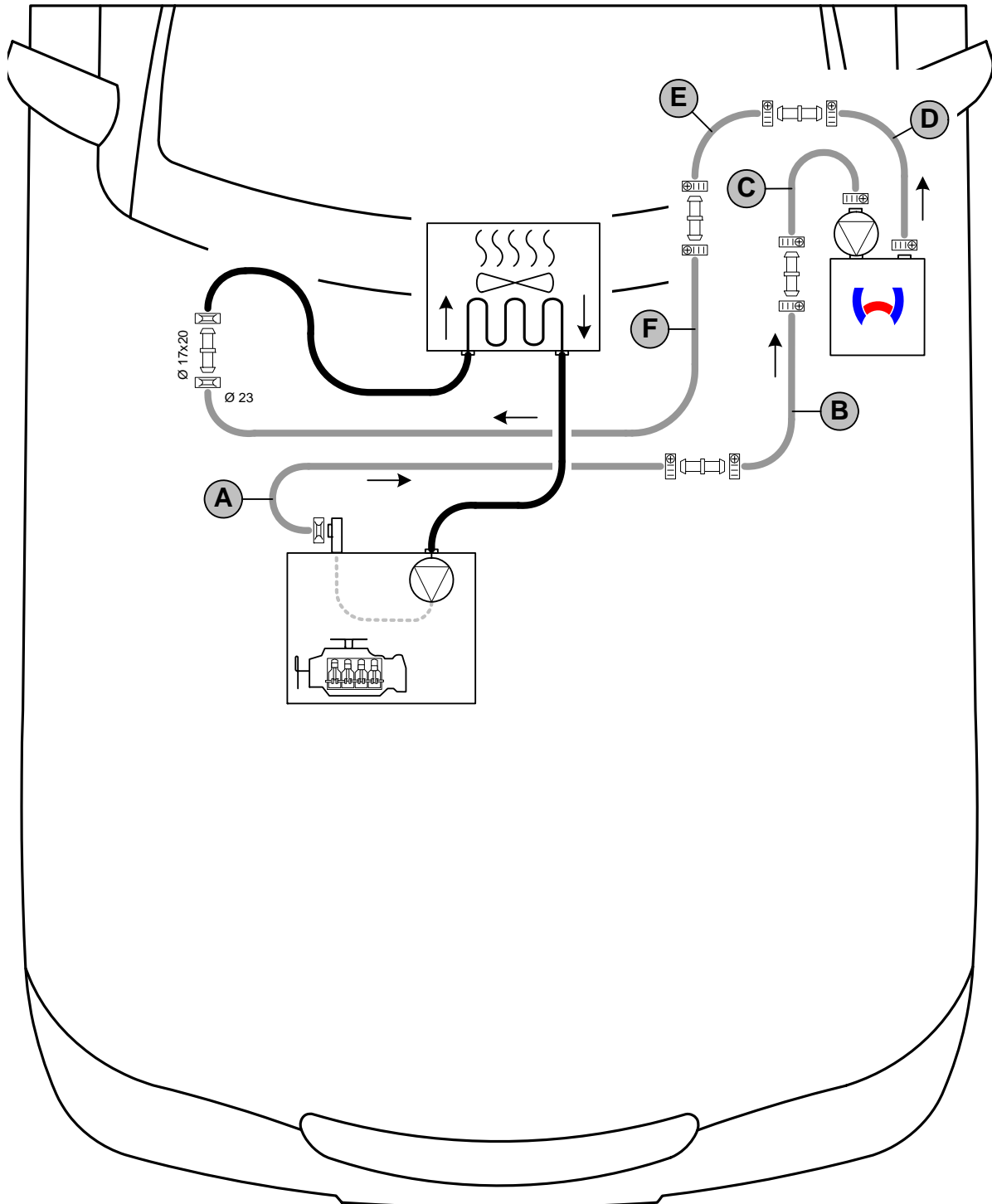
Any coolant running off should be collected using an appropriate container. Install hoses so that they are kink-free. Unless specified otherwise, always fasten using cable ties. Position clamps so that other hoses cannot be damaged. When installing the coolant hose, the heater must be filled with coolant. The connection should be "inline" based on the following diagram:



Coolant routing diagram

All spring clips without a specific designation  = 27 mm dia. All hose clamps  = 20-27 mm dia. All connecting pipes without a specific designation  = dia. 20x20 mm.



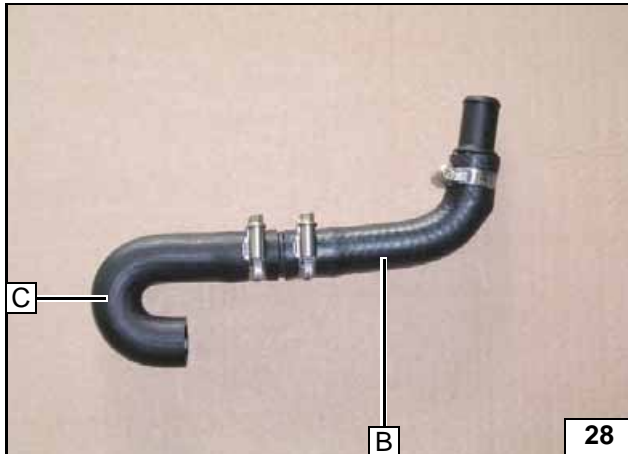

Premounting hose B and C

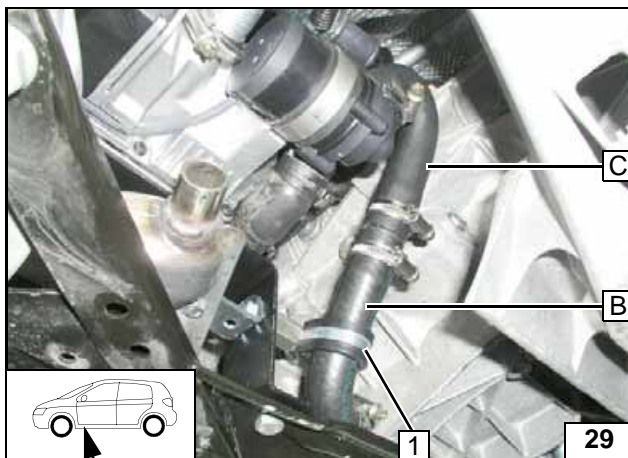

1 29 mm dia. rubber-coated p-clamp, M6x16 bolt, spring lockwasher on 30 mm spacer nut

Mounting hose B and C

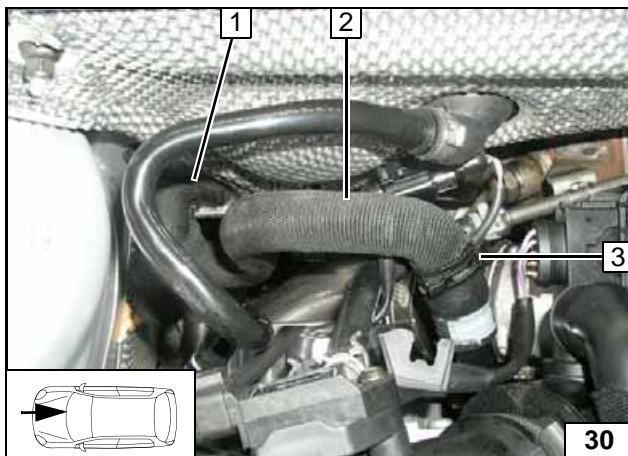

Disconnect hose from engine outlet / heat exchanger inlet 2 at connection piece of engine outlet. Discard original vehicle clamp 3. Push rubber grommet of coolant reservoir 1 inward.



Cutting point

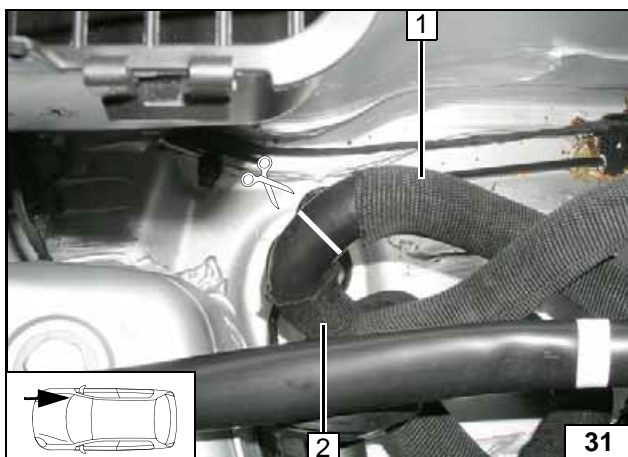

1 Hose section of heat exchanger inlet
2 Hose section on engine outlet (pushed through to inside)

Cutting point

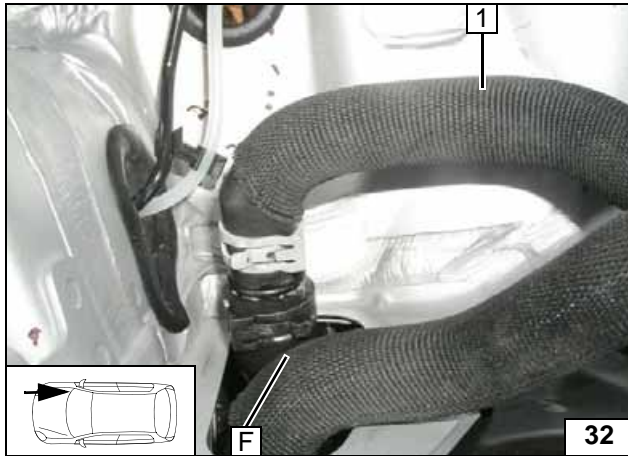

Route hose **F** with short 90° elbow from engine compartment through protective rubber plug and connect to hose section on heat exchanger inlet **1**.



Connection of heat exchanger inlet

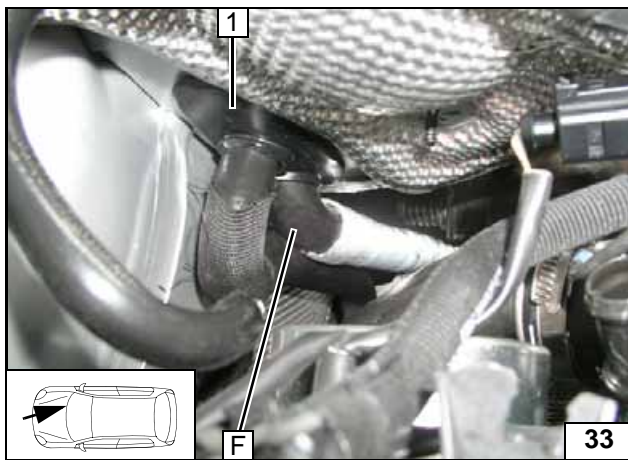

Align hose **F** relative to coolant reservoir. Insert protective rubber plug **1** in pass through.



Routing hose F

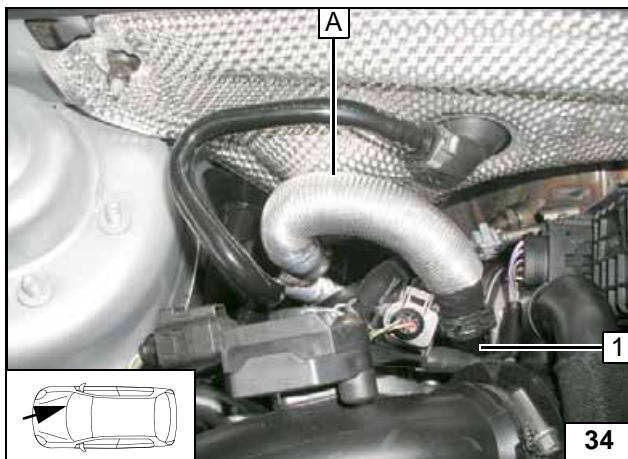

1 Connection piece for engine outlet

Connecting engine outlet

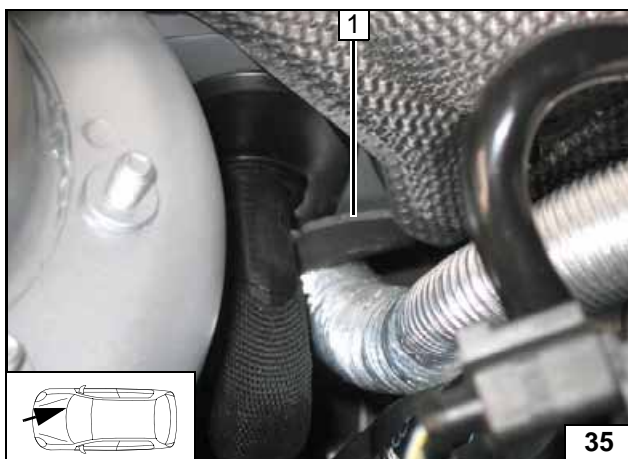

1 Insulating guard

Gluing on insulating guard

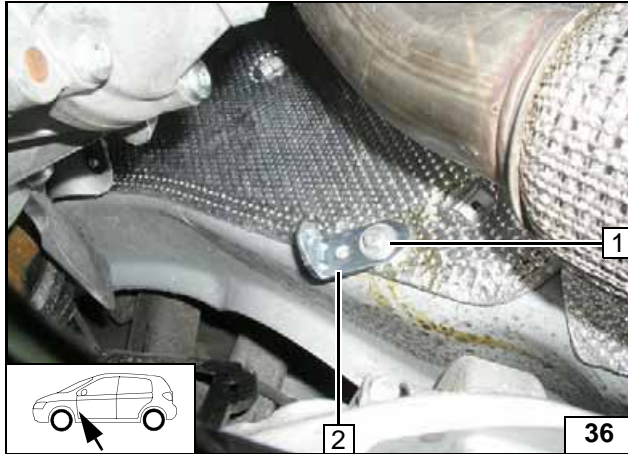

4.8 mm dia. hole at position 1.

- 1 5.5x13 self-tapping screw, large diameter washer
- 2 Angle bracket



Mounting angle bracket

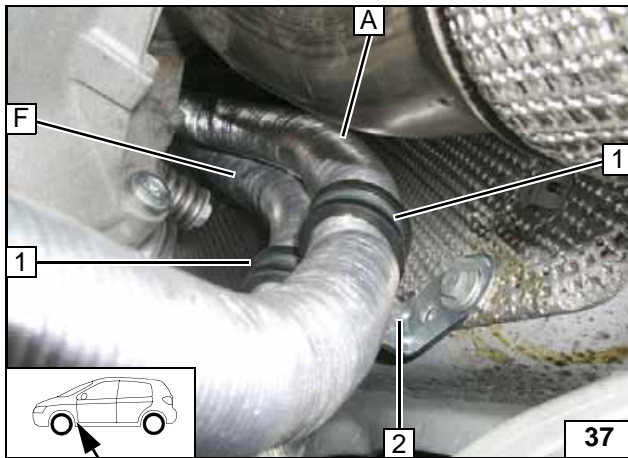

- 1 29 mm dia. rubber-coated p-clamp [2x]
- 2 M6x30 bolt, flanged nut on angle bracket

Fastening hoses A and F

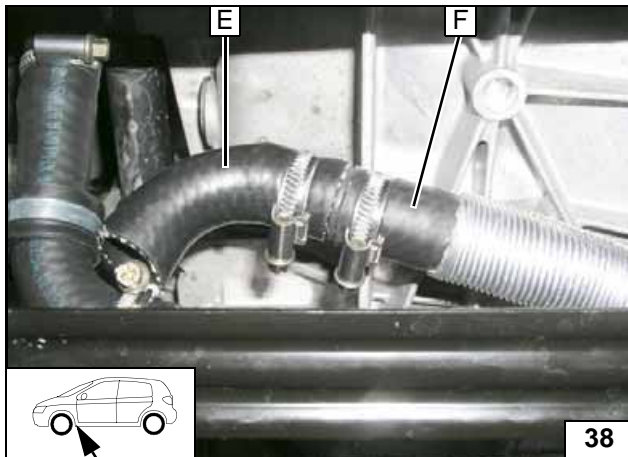

Connect hose E and F and route to heater outlet.



Connecting hoses E and F

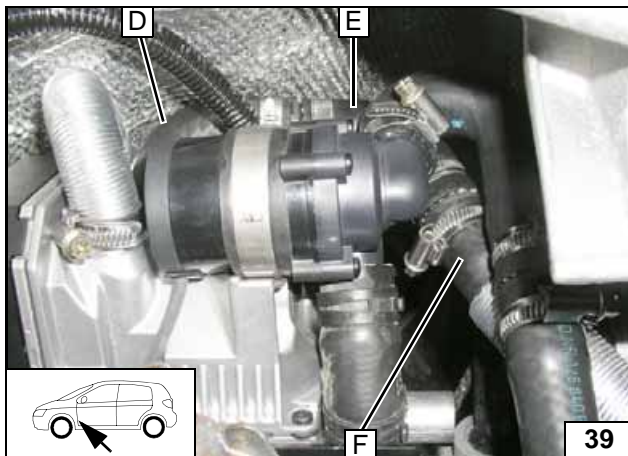

Connecting hoses D and E

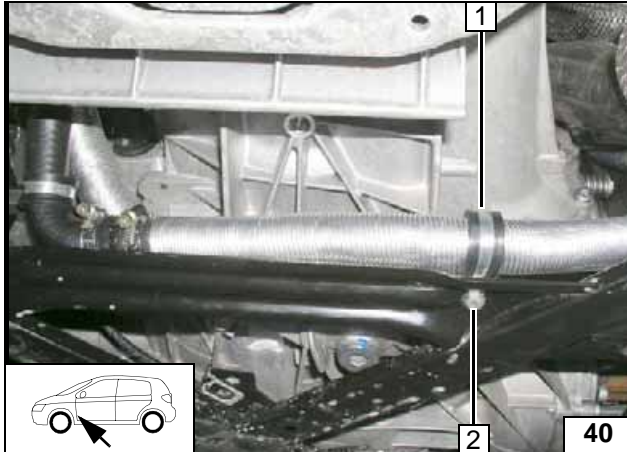

Check the position of the components; adjust if necessary. Check that they have freedom of movement.

- 1 29 mm dia. rubber-coated p-clamp [2x]
- 2 Mount M6x30 bolt, flanged nut in existing hole



Fastening hoses A and F



Fuel

CAUTION!

Open the vehicle's fuel tank cap, ventilate the tank and then re-close the tank lock.

Catch any fuel running off with an appropriate container.

Install fuel line and metering pump wiring harness so that they are protected against stone impact. Unless specified otherwise, always fasten using cable ties. Mount the fuel line and wiring harness with rub protection on sharp edges.

WARNING!

The fuel line and wiring harness are routed to the metering pump as shown in the wiring harness routing diagram.

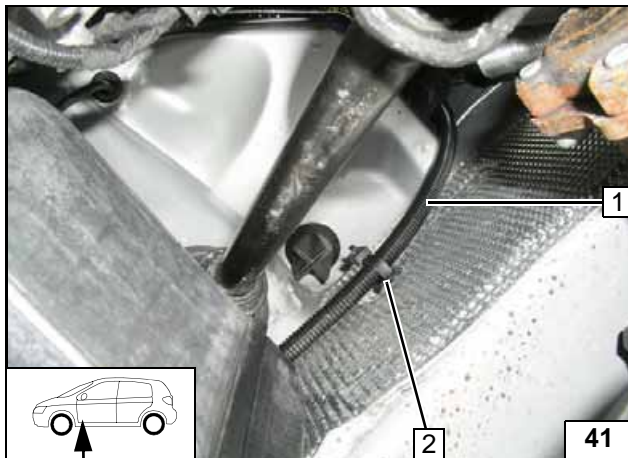

- 1 Fuel line in corrugated tube
- 2 Replace retaining clip (if installed) with clip-type cable tie

Installing lines

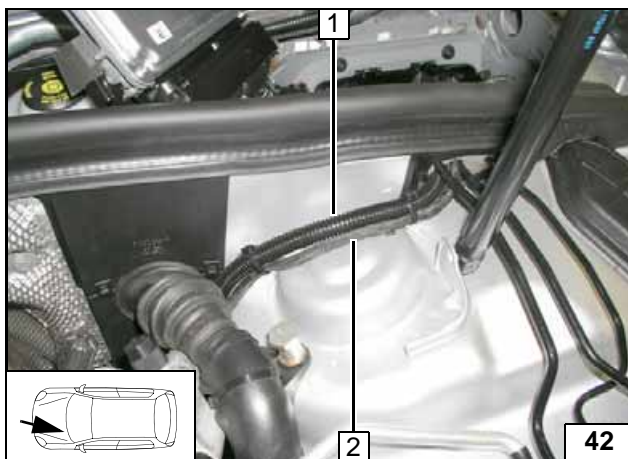

- 1 Fuel line in corrugated tube
- 2 Wiring harness of heater

Installing lines

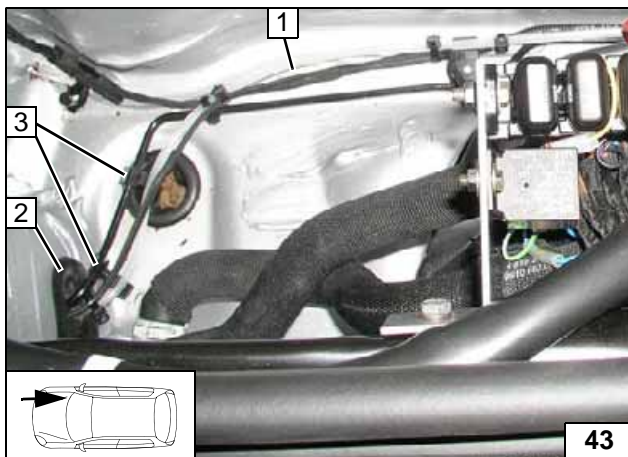

- 1 Fuel line, wiring harness of metering pump
- 2 Original vehicle protective rubber plug on wheel well
- 3 Spacer bracket [2x]

Installing lines

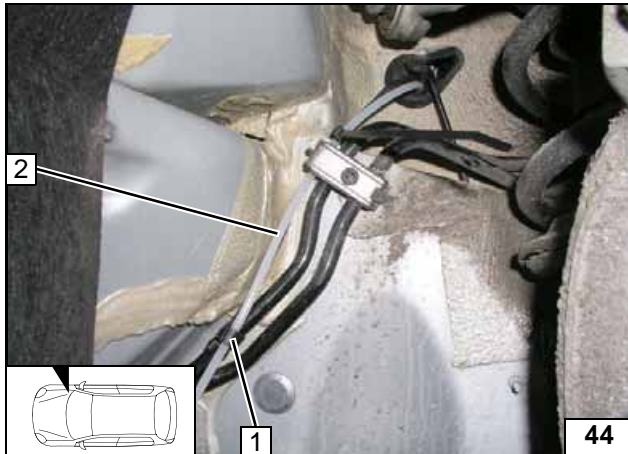

- 1 Spacer bracket
- 2 Fuel line, wiring harness of metering pump

Installing lines

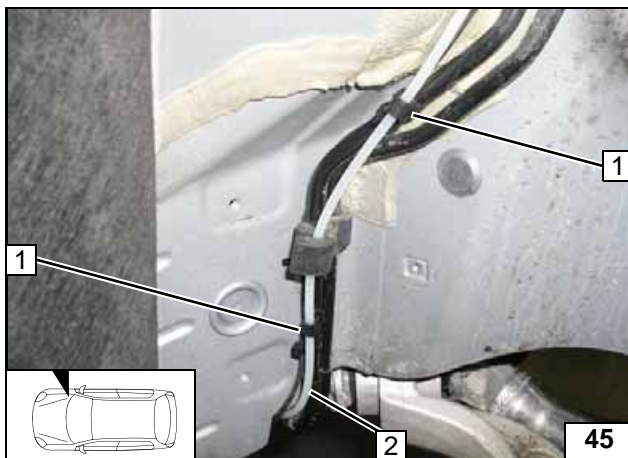

- 1 Spacer bracket [2x]
- 2 Fuel line, wiring harness of metering pump

Installing lines

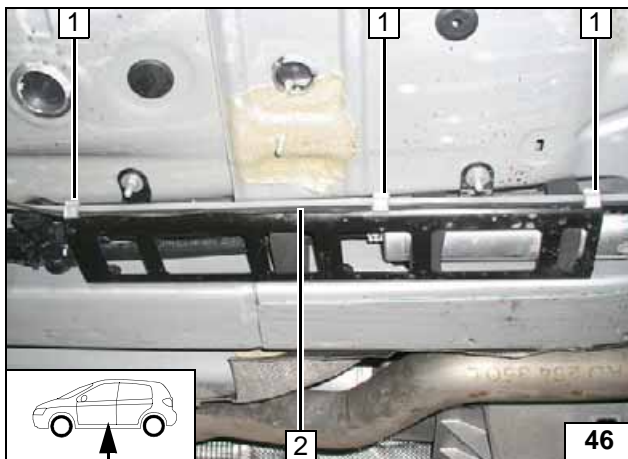

- 1 Clamping bracket [3x]
- 2 Fuel line, wiring harness of metering pump

Installing lines

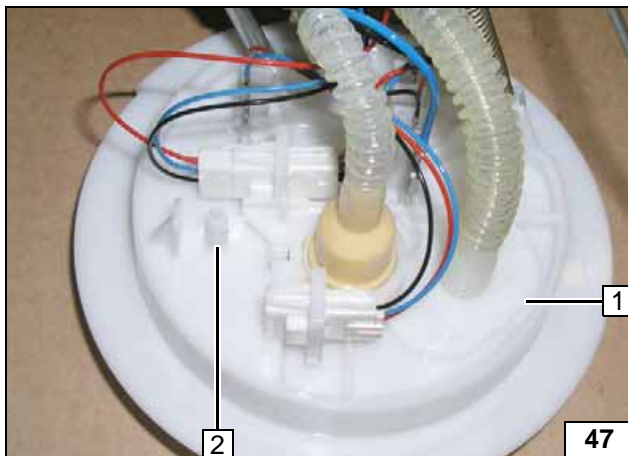

Remove and dismantle fuel-tank sending unit 1 according to manufacturer's instructions. Drill out connection piece 2 at centre with 2.0 mm dia. drill bit. Remove drilling chips.



Fuel extraction

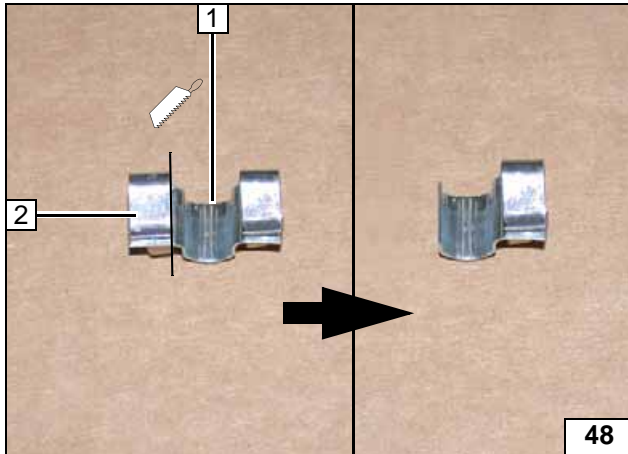

Cut off retaining clamp 1 at marking.

2 Discard section



Cutting retaining clamp to size

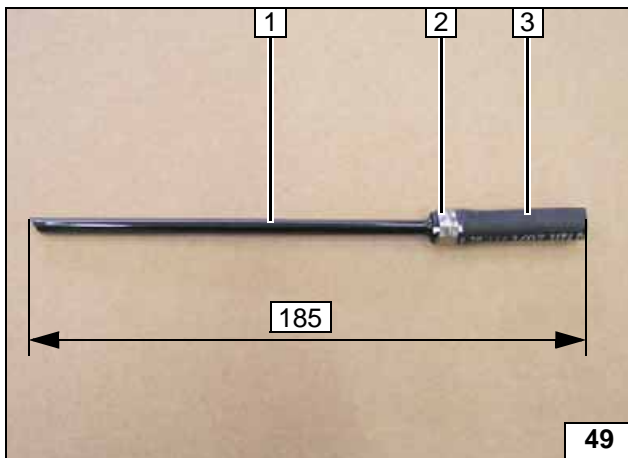

Mount standpipe 1 (with side without beads) in hose section 3 and fasten with 10 mm dia. Caillau clamp 1.
Cut standpipe 1 to length at the end at an angle.



Preparing fuel standpipe

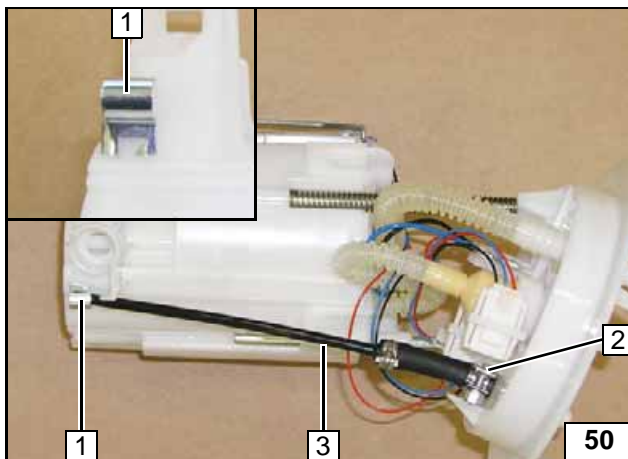

Note

The installation of the retaining clamp depends on the equipment and is not possible with all fuel-tank sending units.

Mount retaining clamp 1 on fuel-tank sending unit.

- 2 10 mm dia. clamp
- 3 Prepared fuel standpipe



Installing fuel standpipe

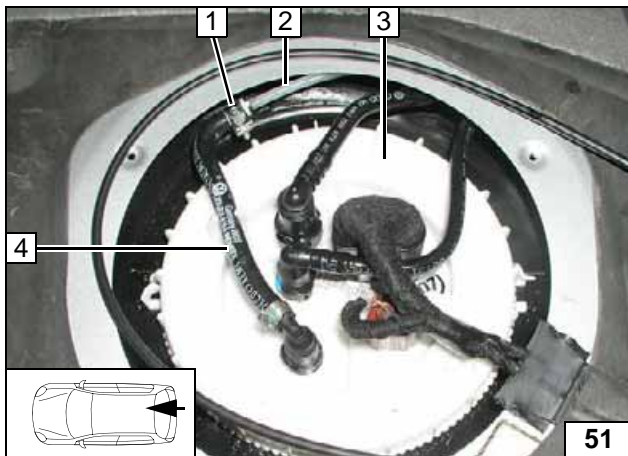

Install fuel-tank sending unit 3 in accordance with manufacturer's instructions. Mount quick-release coupling 4 on connection piece.

- 1 10 mm dia. clamp
- 2 Fuel line



Connecting fuel line

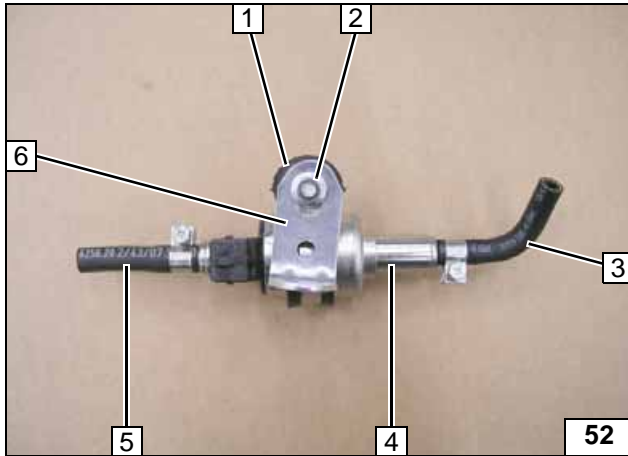

- 1 Silent block
- 2 Flanged nut
- 3 90° moulded hose, 10 mm dia. clamp
- 4 Metering pump
- 5 Hose section, 10 mm dia. clamp
- 6 Angle bracket

Premounting metering pump

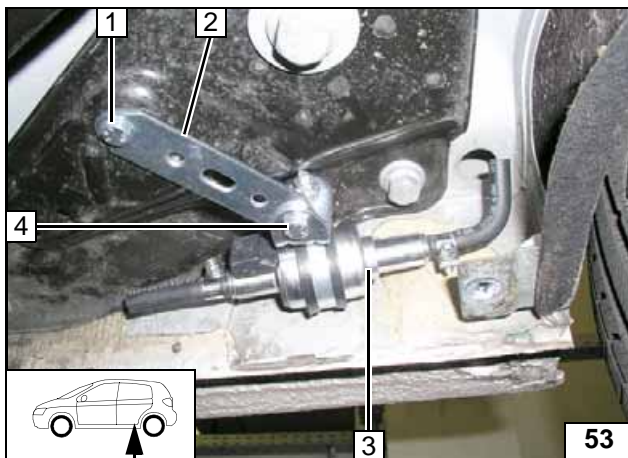

- 1 Mount M6x20 bolt, flanged nut in existing hole
- 2 Perforated bracket
- 3 Premounted metering pump
- 4 M6x20 bolt, flanged nut on angle bracket



Installing metering pump

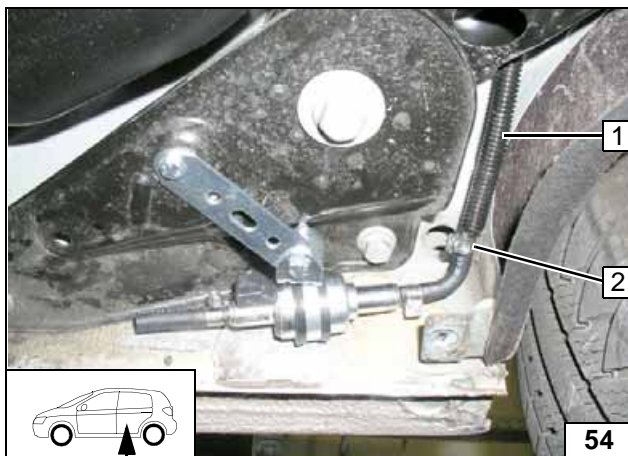

Cut corrugated tube in middle. Slide one end onto the fuel line to the fuel standpipe and the other end onto the fuel line to the heater and the wiring harness of the metering pump.

- 1 Fuel line in corrugated tube
- 2 10 mm dia. clamp



Connecting metering pump

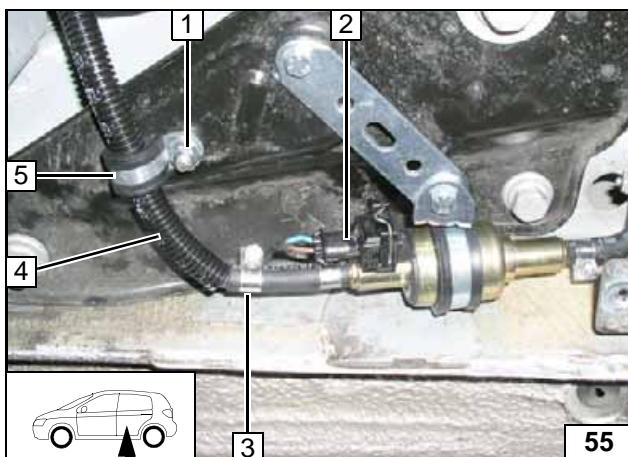

Check the position of the components; adjust if necessary. Check that they have freedom of movement.

- 1 Mount M6x20 bolt, flanged nut in existing hole
- 2 Wiring harness of metering pump, connector mounted
- 3 10 mm dia. clamp
- 4 Fuel line and wiring harness for metering pump in corrugated tube
- 5 15 mm dia. rubber-coated p-clamp



Connecting metering pump

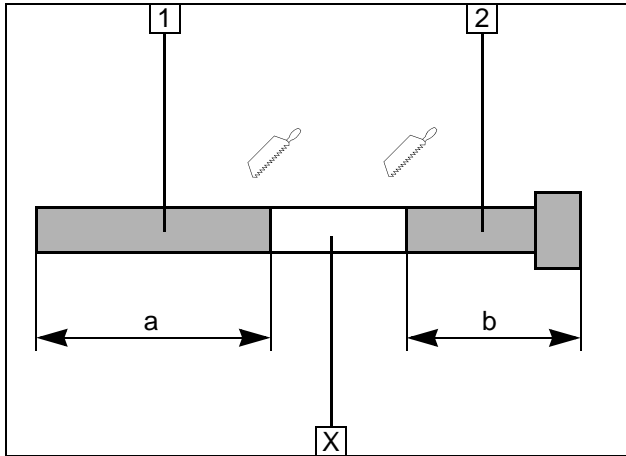

Exhaust Gas

Discard section X

- 1 Exhaust pipe
a = 260
- 2 Exhaust end section
b = 110

Preparing exhaust pipe

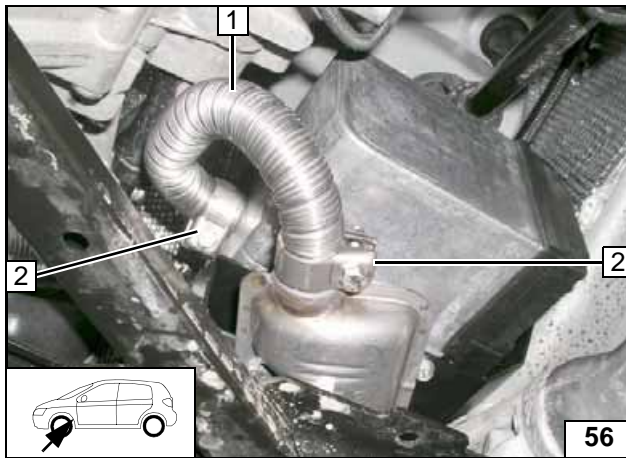

- 1 Exhaust pipe
- 2 Hose clamp [2x]

Installing exhaust pipe

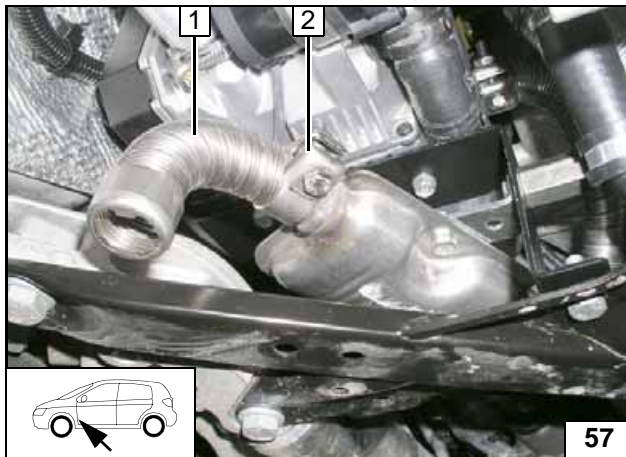

- 1 Exhaust end section
- 2 Hose clamp

Installing exhaust end section

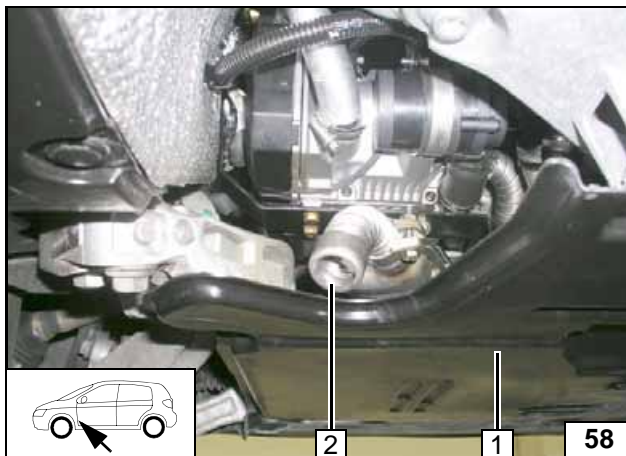

- 1 Underdrive protection
- 2 Exhaust end section

Aligning exhaust end section

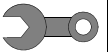

Final Work

WARNING!

Reassemble the disassembled components in reverse order.

Check all hoses, clamps and all electrical connections for firm seating.

Secure all loose lines using cable ties.

Only use manufacturer-approved coolant.

Spray the heater components with anti-corrosion wax (Tectyl 100K, Order No. 111329).

- **Connect the battery.**
- **Fill and bleed the coolant circuit according to the vehicle manufacturer's specifications.**
- **Set the digital timer.**
- **Make settings on A/C control panel according to the "Operating Instructions for End Customer".**
- **Check the proper function of the parking heater, see the operating instructions/installation instructions.**
- **Attach the "Switch off parking heater before refueling" sticker to the left-hand B-pillar.**

Coding of Control Unit of Climatronic J255

in "Guided functions" mode with VAS 5051/52

Function:

- **08** Heating / Air Conditioning
- **10** Adaptation

Code channel **17** - from "**0**" to "**1**"

Save



Operating Instructions for End Customer



Please remove page and add to the vehicle operating instructions.



Note:

We recommend matching the heating time to the driving time.

Heating time = driving time

Example:

For a driving time of approx. 20 min. (in one direction), we recommend not exceeding a switch-on time of 20 min.

If the summer/winter switch option has been installed on the heater, it must be switched in accordance with the time of year. The heater will then heat in the position Winter  and in the position Summer  it will only switch on the vehicle fan to ventilate the vehicle interior.



Before parking the vehicle, make the following settings:



- 1 Air outlet to windscreen
- 2 Set temperature on both sides to "HI".

2 Zone A/C control panel



- 1 Air outlet to windscreen
- 2 Set temperature to "HI"

1 Zone A/C control panel

