

Water Heater

Thermo Top Evo Parking Heater



Installation Documentation

Audi A3 / A3 Convertible

Validity

Manufacturer	Model	Type	EG-BE-No. / ABE
Audi	A3	8V	e1 * 2007 / 46 * 0607 * ...
Audi	A3 Convertible	8V	e1 * 2007 / 46 * 0607 * ...

Motorisation	Fuel	Transmission type	Output in kW	Displacement in cm ³	Engine code
1.4 TFSI	Petrol	SG	90	1395	CMBA
1.4 TFSI	Petrol	SG	103	1395	CPTA
1.4 TFSI	Petrol	S tronic	103	1395	CHPA
1.8 TFSI	Petrol	SG	132	1798	CJSA
1.8 TFSI	Petrol	S tronic	132	1798	CJSA
1.6 TDI	Diesel	SG	77	1598	CLHA
1.6 TDI	Diesel	S tronic	77	1598	CLHA
2.0 TDI	Diesel	SG	110	1968	CRBC

SG = manual transmission

S tronic = dual clutch transmission

From model year 2012

Left-hand drive vehicle

Verified equipment variants: Climatic / Climatronic

Front fog lights

Xenon

Headlight washer system

Start-Stop

Not verified:

Passenger compartment monitoring

quattro

Exclusion:

Rough Road Suspension incl. stoneguard

Total installation time:

about 8.5 hours

Audi A3 / A3 Convertible

Table of Contents

Validity	1	MultiControl CAR Option	14
Necessary Components	2	Remote Option (Telestart)	14
Installation Overview	2	Remote Option (Thermo Call)	15
Information on Total Installation Time	2	Preparing Installation Location	16
Information on Operating and Installation Instructions	3	Preparing Heater	16
Information on Validity	4	Installing Heater	20
Technical Instructions	4	Fuel	22
Explanatory Notes on Document	4	Combustion Air	28
Preliminary Work	5	Coolant Circuit FSI	29
Heater Installation Location	5	Coolant Circuit TDI	35
Preparing Electrical System	6	Final Work	39
Elektrical System Variant A	9	Operating Instructions for Climatic	41
Elektrical System Variant B	10	Operating Instructions for Climatronic	43
Fan Controller	12		

Necessary Components

- Basic delivery scope of *Thermo Top Evo* based on price list
- Installation kit for Audi A3 / A3 Convertible 2012 Petrol and diesel: **1318914B**
- For **1.8 TFSI** also required: Additional kit exhaust gas MQB 1.8 TSi/TFSi: **1321303A**
- Heater control in accordance with price list and upon consultation with end customer
- In case of Telestart, Indicator lamp in accordance with price list and upon consultation with final customer

Installation instructions:

- Arrange for the vehicle to be delivered with the tank only about $\frac{1}{4}$ full!
- The installation location of the push button in the case of Telestart or Thermo Call should be confirmed with the end customer.
- Depending on the available space and manufacturer's instructions, we recommend the use of a vehicle battery with more electrical capacity.

Installation Overview

Legend:

1. Heater
2. Fuse holder engine compartment
3. Passenger compartment relay and fuse holder
4. Circulating pump
5. MultiControl CAR
6. Metering pump

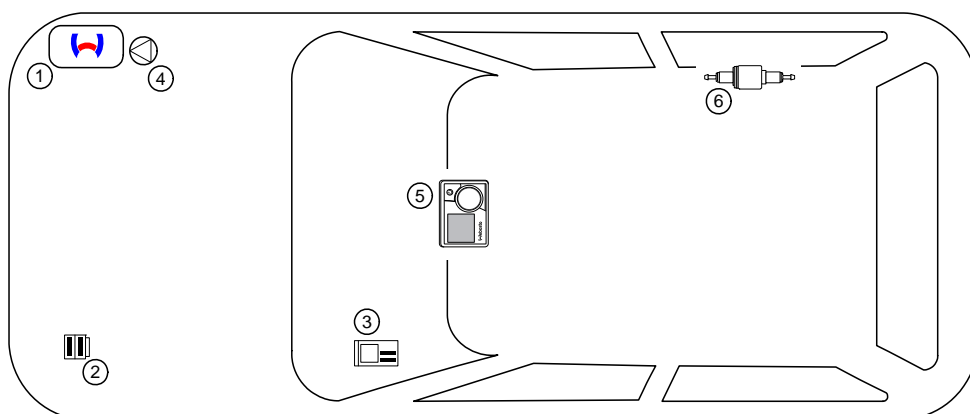

Information on Total Installation Time

The total installation time includes the time needed for mounting and demounting of the vehicle-specific components, the heater specific installation time and all other times required for the system integration and initial start-up of the heater.

The total installation time may vary for vehicle equipment other than provided.

Information on Operating and Installation Instructions

1 Important information (not complete)

1.1 Installation and repair



The improper installation or repair of Webasto heating and cooling systems can cause fire or the leakage of deadly carbon monoxide, leading to serious injury or death.



To install and repair Webasto heating and cooling systems you need to have completed a special company training course and have the appropriate technical documentation, special tools and special equipment.



Installation and repair may ONLY be carried out by persons trained and certified in a Webasto training course. NEVER try to install or repair Webasto heating or cooling systems if you have not completed a Webasto training course, you do not have the necessary technical skills and you do not have the technical documentation, tools and equipment available to ensure that you can complete the installation and repair work properly.

Only use genuine Webasto parts. See the Webasto air and water heaters accessories catalogue for this purpose.

1.2 Operation

To ensure safe operation, we recommend having the heater checked every two years by an authorised Webasto dealer, especially when used over a long period and/or under extreme environmental conditions.

Do not operate the heater in closed rooms due to the danger of poisoning and suffocation.

Always switch off the heater before refuelling.

The heater may only be used with the prescribed fuel Diesel (DIN EN 590) or petrol (DIN EN 227).

The heater may not be cleaned with a high-pressure cleaner.

1.3 Please note

ALWAYS follow all Webasto installation and operating instructions and observe all warnings.

To become familiar with and understand all functions and properties of the heater, the operating instructions must be read carefully and observed at all times.

For proper, safe installation and repair work, the installation instructions with all warnings and safety information must be carefully read and observed at all times. Please always contact a workshop authorised by Webasto for all installation and repair work.

Important

Webasto shall assume no liability for defects, damage and injuries resulting from a failure to observe the installation, repair and operating instructions of the information contained in them.

This liability exclusion particularly applies to improper installations and repairs, installations and repairs by untrained persons or in the case of a failure to use genuine spare parts.

The liability due to culpable disregard to life, limb or health and due to damage or injuries caused by a wilful or reckless breach of duty remain unaffected, as does the obligatory product liability.

Installation should be carried out according to the general, standard rules of technology. Unless specified otherwise, fasten hoses, lines and wiring harnesses to original vehicle lines and wiring harnesses using cable ties. Insulate loose wire ends and tie back. Connectors on electronic components must audibly click into place during installation.

Sharp edges should be fitted with rub protection. Spray unfinished body areas, e.g. drilled holes, with anti-corrosion wax (Tectyl 100K, Order No. 111329).

Observe the instructions and guidelines of the respective vehicle manufacturer for demounting and mounting vehicle specific components!

The initial start-up is to be executed with the Webasto Thermo Test Diagnosis.

When installing a programmable control module (e.g. a PWM Gateway), the corresponding settings must be checked or adjusted.

2 Statutory regulations governing installation

Guidelines	Thermo Top Evo
Heating Directive ECE R122	E1 00 0258
EMC Directive ECE R10	E1 04 5627

Note

The regulations of these guidelines are binding in the scope of the Directive 70/156/EEC and/or 2007/46/EC (for new vehicle models from 29/04/2009) and should also be observed in countries in which there are no special regulations.

Important

Failure to follow the installation instructions will result in the invalidation of the type approval for the heater and therefore invalidation of the general **homologation of the vehicle**.

Note

The heater is licensed in accordance with paragraph 19, section 3, No. 2b of the StVZO (German Road Traffic Licensing Authority).

2.1 Excerpt from the directive 122 (heater) section 5 for the installation of the heater.

Beginning of excerpt.

ANNEX VII

REQUIREMENTS FOR COMBUSTION HEATERS AND THEIR INSTALLATION

1. GENERAL REQUIREMENTS

1.7.1. A clearly visible tell-tale in the operator's field of view shall inform when the combustion heater is switched on or off.

2. VEHICLE INSTALLATION REQUIREMENTS

2.1. Scope

2.1.1. Subject to paragraph 2.1.2. combustion heaters shall be installed according to the requirements of this Annex.

2.1.2. Vehicles of category O having liquid fuel heaters are deemed to comply with the requirements of this Annex.

2.2. Positioning of the heater

2.2.1. Body sections and any other components in the vicinity of the heater must be protected from excessive heat and the possibility of fuel or oil contamination.

2.2.2. The combustion heater shall not constitute a risk of fire, even in the case of overheating. This requirement shall be deemed to be fulfilled if the installation ensures an adequate distance to all parts and suitable ventilation, by the use of fire resistant materials or by the use of heat shields.

2.2.3. In the case of M2 and M3 vehicles, the heater must not be positioned in the passenger compartment. However, an installation in an effectively sealed envelope which also complies with the conditions in paragraph 2.2.2 may be used.

2.2.4. The label referred to in paragraph 1.4 or a duplicate, must be positioned so that it can be easily read when the heater is installed in the vehicle.

2.2.5. Every reasonable precaution should be taken in positioning the heater to minimise the risk of injury and damage to personal property.

2.3. Fuel supply

2.3.1. The fuel filler must not be situated in the passenger compartment and must be provided with an effective cap to prevent fuel spillage

2.3.2. In the case of liquid fuel heaters, where a supply separate to that of the vehicle is provided, the type of fuel and its filler point must be clearly labelled

2.3.3. A notice, indicating that the heater must be shut down before refuelling, must be affixed to the filler neck. In addition a suitable instruction must be included in the manufacturer's operating manual.

2.4. Exhaust system

2.4.1. The exhaust gas outlet must be located so as to prevent emissions from entering the vehicle through ventilators, heated air inlets or opening windows.

2.5. Combustion air inlet

2.5.1. The air for the combustion chamber of the heater must not be drawn from the passenger compartment of the vehicle.

2.5.2. The air inlet must be so positioned or guarded that blocking by rubbish or luggage is unlikely.

2.6. Heating air inlet

2.6.1. The heating air supply may be fresh or recirculated air and must be drawn from a clean area not likely to be contaminated by exhaust fumes emitted either by the propulsion engine, the combustion heater or any other vehicle source.

2.6.2. The inlet duct must be protected by mesh or other suitable means.

2.7. Heating air outlet

2.7.1. Any ducting used to route the hot air through the vehicle must be so positioned or protected that no injury or damage could be caused if it were to be touched.

2.7.2. The air outlet must be so positioned or guarded that blocking by rubbish or luggage is unlikely.

End of excerpt.

In multilingual versions the German language is binding.

Audi A3 / A3 Convertible

Information on Validity

This installation documentation applies to Audi A3 / A3 Convertible Petrol and diesel vehicles - for validity, see page 1 - from model year 2012 and later, assuming technical modifications to the vehicle do not affect installation, any liability claims excluded. Depending on the vehicle version and equipment, modifications may be necessary during installation with respect to this installation documentation.

Vehicle and engine types, equipment variants and other specifications not listed in this installation documentation have not been tested. However, installation according to this installation documentation may be possible.

Technical Instructions

Special Tools

- Hose clamp pliers for self-clamping hose clamps
- Hose clamp pliers for Clic hose clamps of type W
- Automatic wire stripper 0.2 - 6mm²
- Crimping pliers for cable lug / tab connector 0.5 - 6mm²
- Torque wrench for 2.0 - 10 Nm
- Hose clamping pliers
- Webasto Thermo Test diagnosis with current software

Measurements

- All measurements are in mm!

Tightening torque values

- Tightening torque values of 5x13 heater bolts = 8Nm.
- Tightening torque value of 5x15 water connection piece retaining plate bolt = 7Nm.
- Tighten other screw connections in accordance with manufacturer's instructions or in accordance with state-of-the-art-technology.

Explanatory Notes on Document

You will find an identification mark on the outside top right corner of the page in question to provide you with a quick overview of the individual working steps.

Special features are highlighted using the following symbols:

Mechanical system



Electrical connection



Coolant circuit



Combustion air

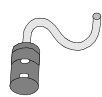

Fuel

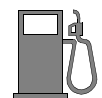

Exhaust gas



Software



Specific risk of injury or fatal accidents



Specific risk of damage to components



Specific risk of fire or explosion



Reference to general installation instructions of the Webasto components or to the manufacturer's vehicle-specific documents



Reference to a special technical feature.



The arrow in the vehicle icon indicates the position on the vehicle and the viewing angle

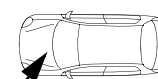
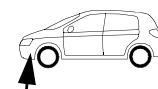

Tightening torque according to the manufacturer's vehicle-specific documents



Audi A3 / A3 Convertible

Preliminary Work

Vehicle

- Open the fuel tank cap.
- Ventilate the fuel tank.
- Close the fuel tank cap again.
- Depressurise the cooling system.
- Disconnect the battery and remove it completely, including the carrier.
- Remove the underride protection.
- Remove the right-hand front wheel.
- Remove the right-hand front wheel well trim.
- Remove the air filter box completely with the radiator intake hose.
- Remove the instrument panel trim on the driver's side.
- Remove the A/C control panel.
- Remove the rear bench seat.
- Open the right-hand tank-fitting service lid.

The following work should only be performed during the corresponding installation sequence:

- Remove the fuel-tank sending unit in accordance with the manufacturer's instructions.

Heater

- Remove years that do not apply from the type and duplicate label.
- Attach the duplicate label (type label) visibly in the appropriate place in the engine compartment.

Note:

The installation steps for the TFSI and the TDI are nearly identical. Deviations were documented, apart from that all images show a 2.0 TDI.

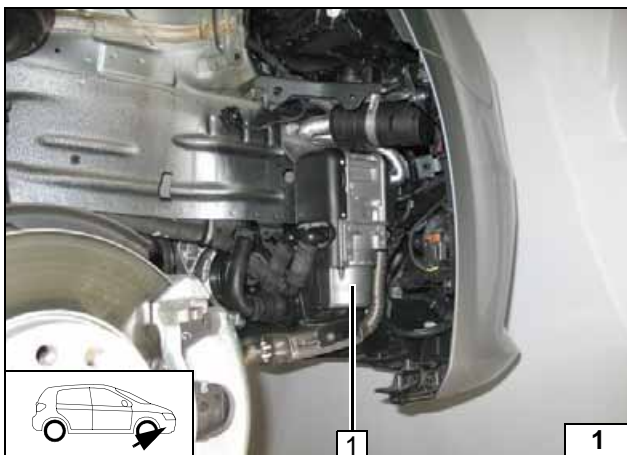

Heater Installation Location

1 Heater

Installation
location

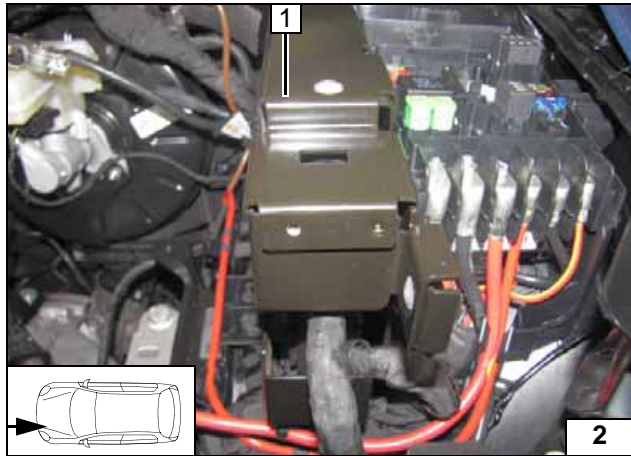
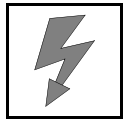

Preparing Electrical System

Wire sections retain their numbering throughout the whole document.

Produce all following electrical connections as shown in wiring diagram.

The installation of the engine compartment fuse holder depends on the equipment.

Variant **A** with protective housing 1
 Variant **B** without protective housing (see following image)



View with protective housing



View without protective housing

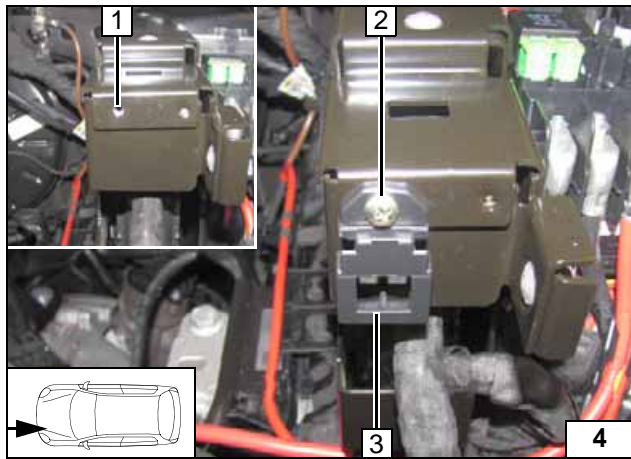

Variant A!

Drill out hole at position 1 to 4mm dia.

- 2 4.8x13 self-tapping screw
- 3 Retaining plate of engine compartment fuse holder



Preparing fuse holder of engine compartment Variant A

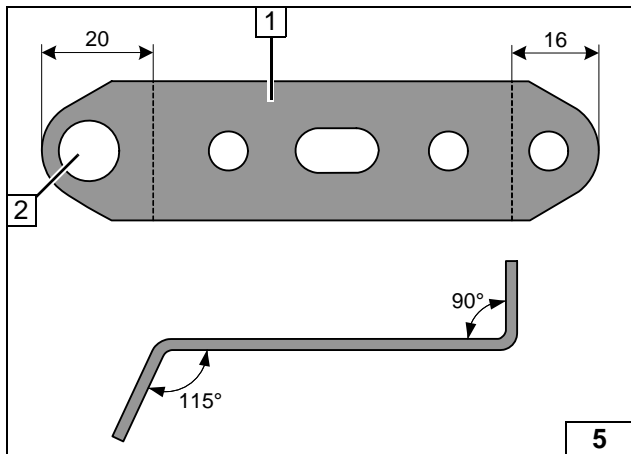

Variant B!

- 1 Perforated bracket
- 2 12.5mm dia. hole



Preparing perforated bracket

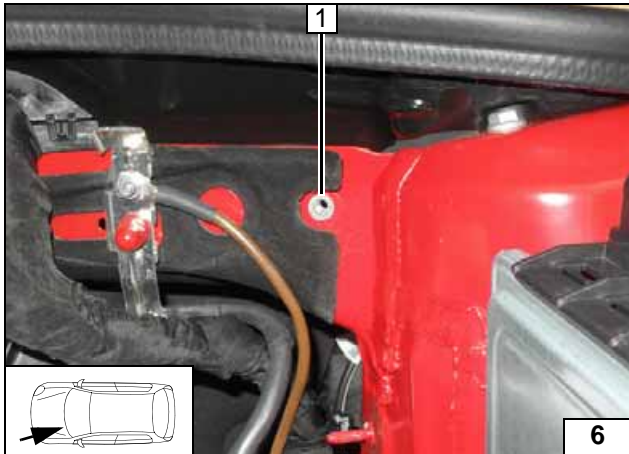

- 1 Drill out existing hole to 9.1mm dia.; rivet nut

Installing rivet nut

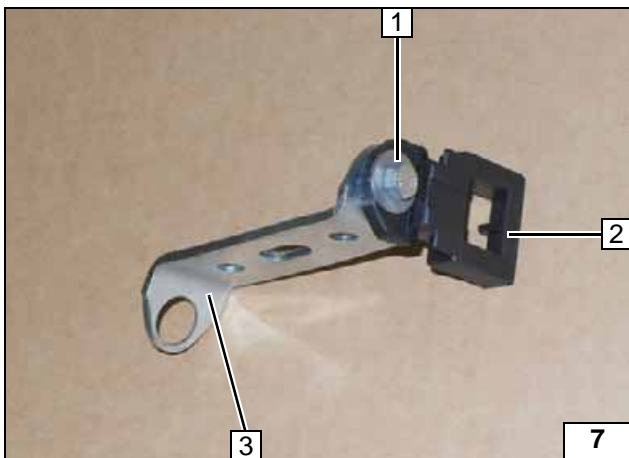

- 1 M5x16 bolt, washer [2x], nut
- 2 Retaining plate of fuse holder
- 3 Perforated bracket

Preparing perforated bracket

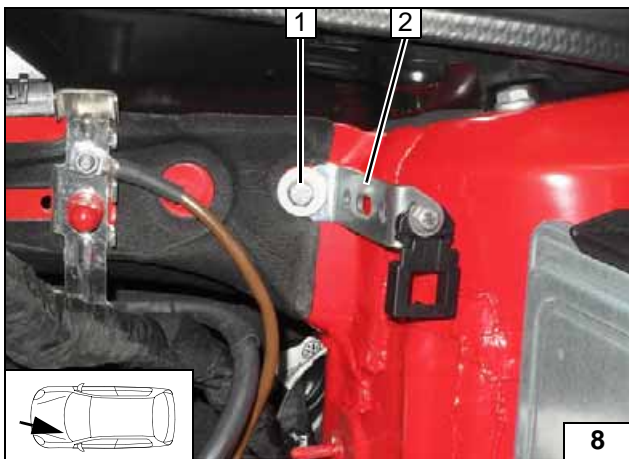

- 1 M6x20 bolt, spring lockwasher, large diameter washer
- 2 Perforated bracket

Installing perforated bracket

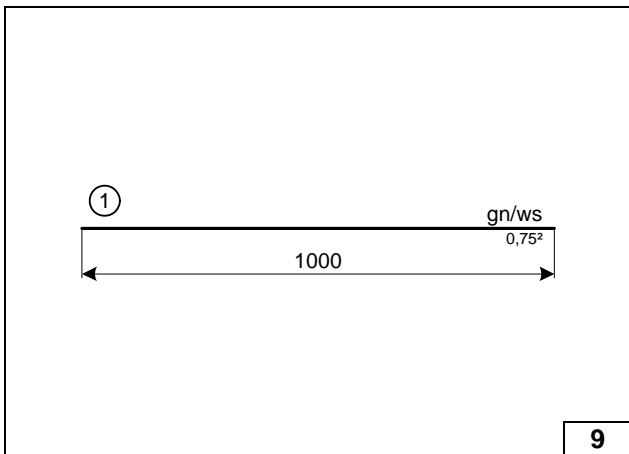

All vehicles

Wire sections retain their numbering throughout the whole document.

Produce all following electrical connections as shown in wiring diagram.

Pull green/white(gn/ws) wire ① into provided protective sleeving.



Assigning / preparing wires

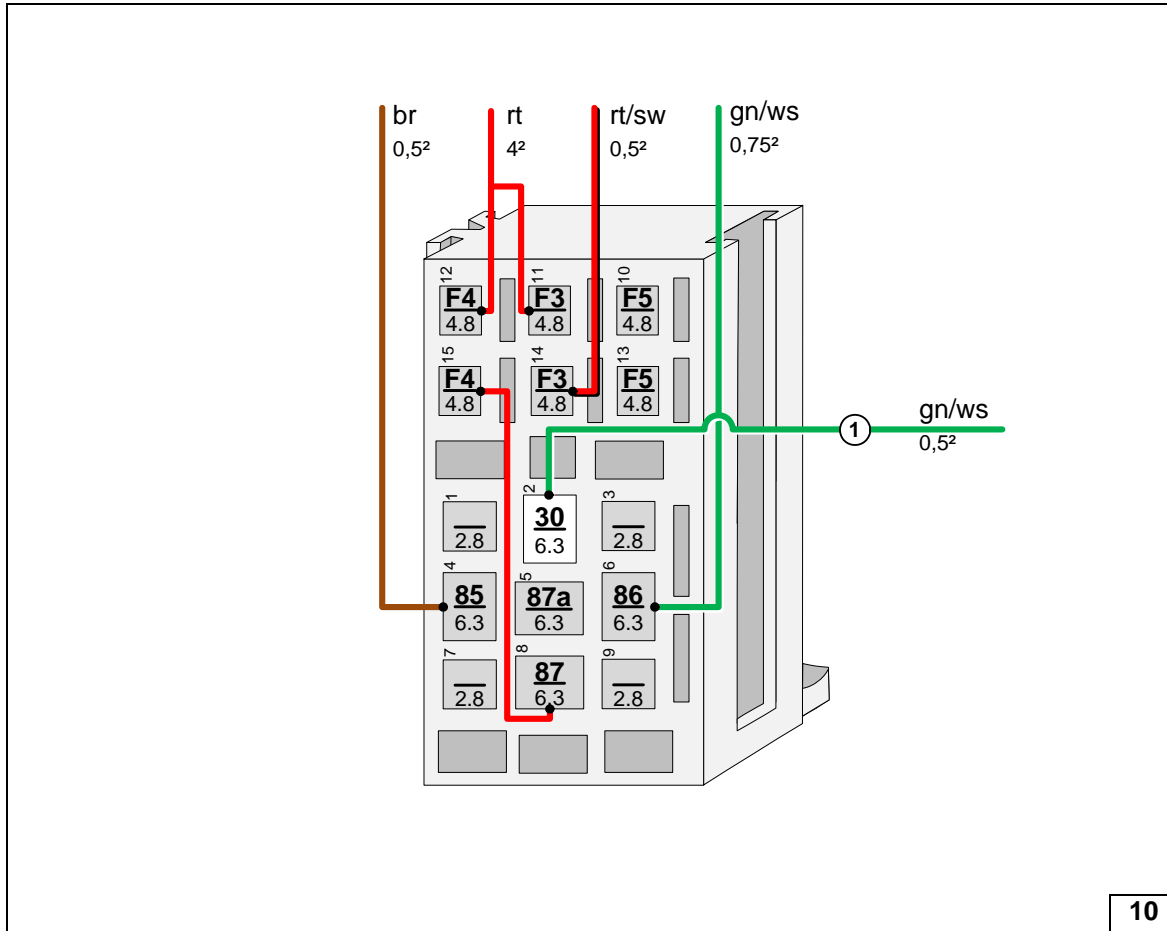

Connecting wire with passenger compartment relay and fuse holder

10

Connector X7

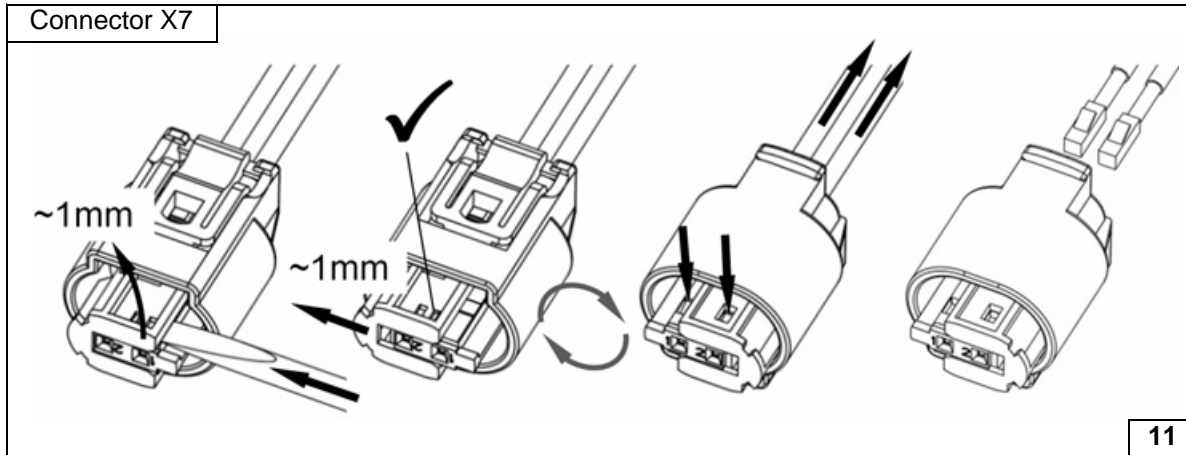

Dismantling connector of metering pump

11



Elektrical System Variant A

Fuse holder of engine compartment - Variant A

See page 11 for wiring harness routing.

- 1 Fuses F1-2
- 2 Diagnosis connector

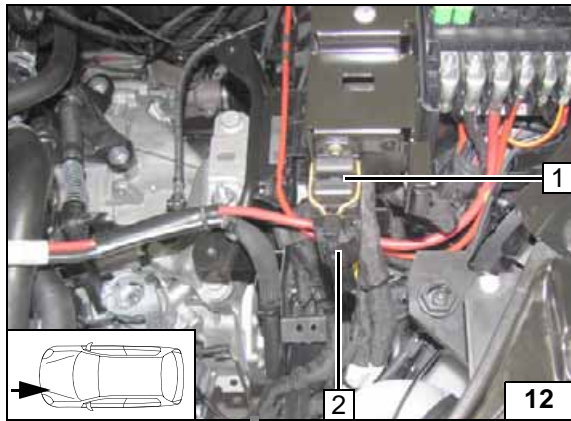

Earth wire

- 1 Earth wire on original vehicle earth support point

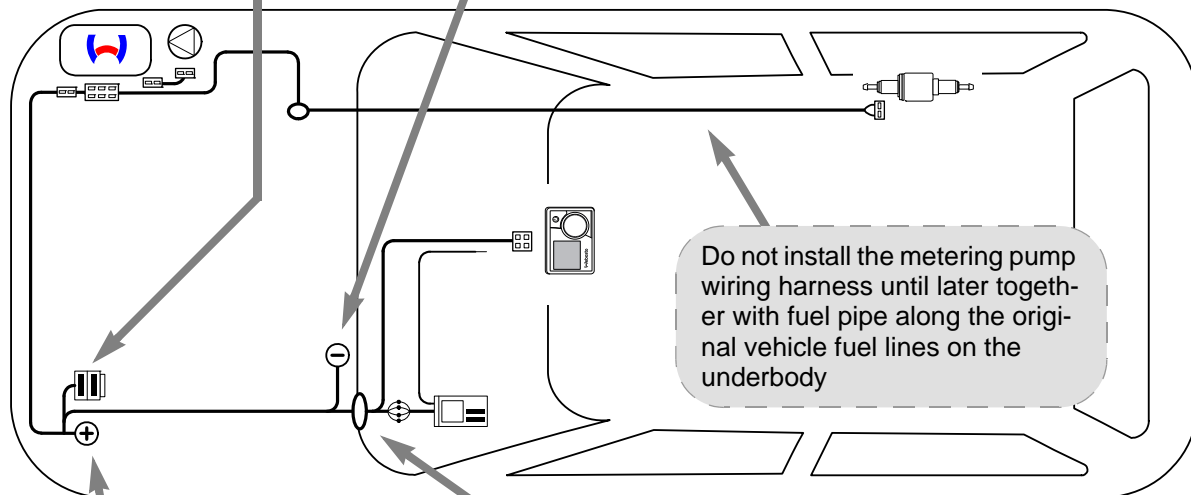
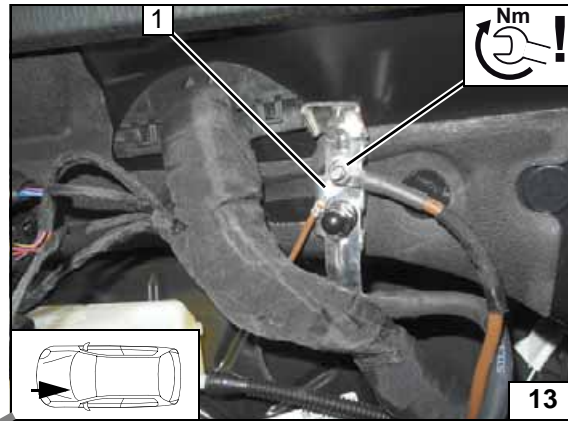

Wiring harness routing diagram

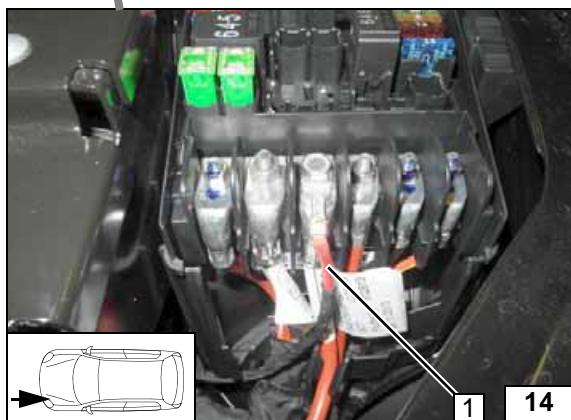

Positive wire

- 1 Positive wire on positive distributor

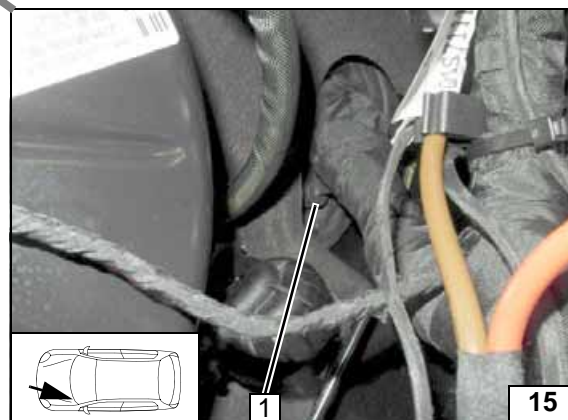

Wiring harness pass through

- 1 Protective rubber plug



Elektrical System Variant B

Fuse holder of engine compartment - Variant B

See page 11 for wiring harness routing.

- 1 Fuses F1-2
- 2 Diagnosis connector

Earth wire

- 1 Earth wire on original vehicle earth support point

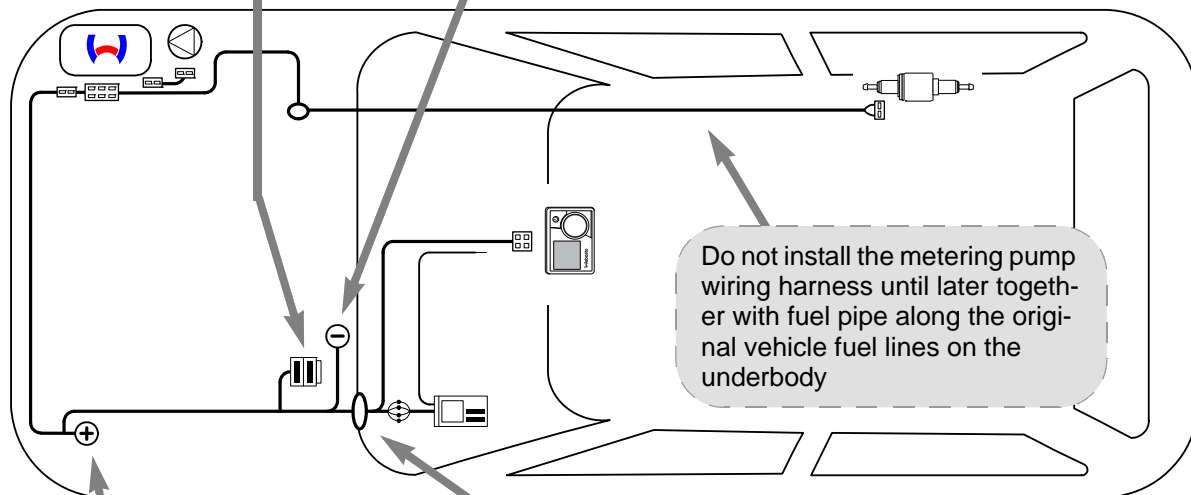
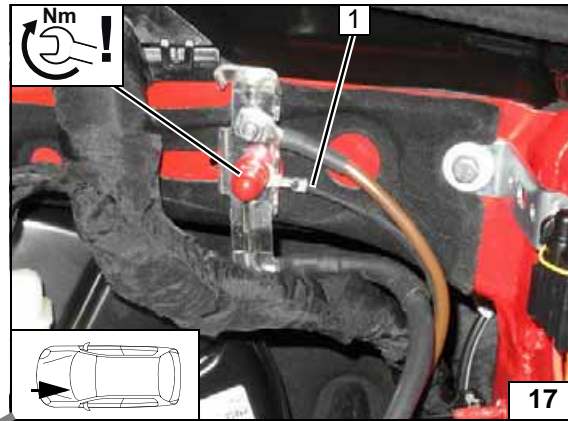
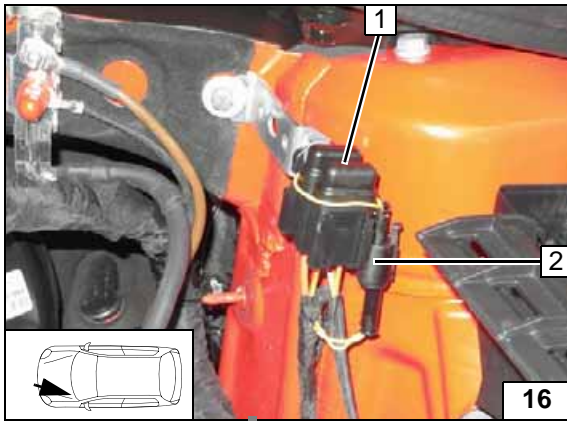

Wiring harness routing diagram

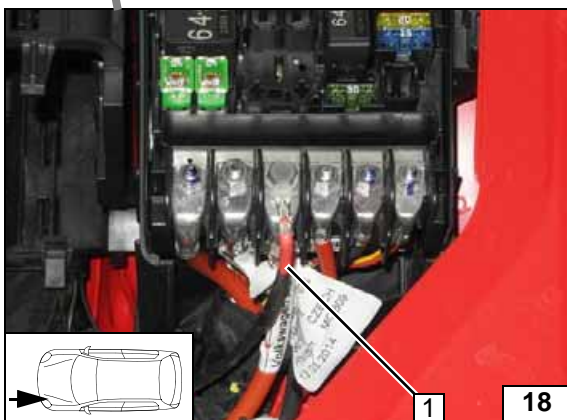

Positive wire

- 1 Positive wire on positive distributor

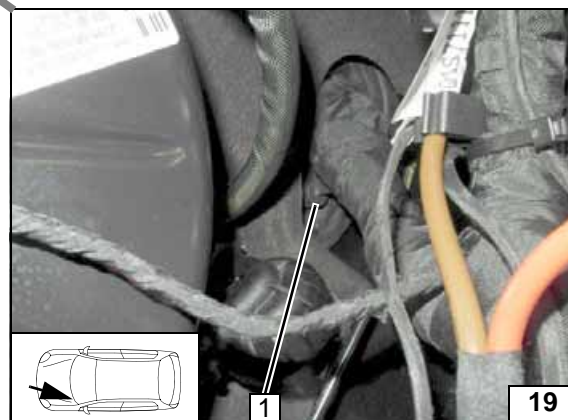

Wiring harness pass through

- 1 Protective rubber plug

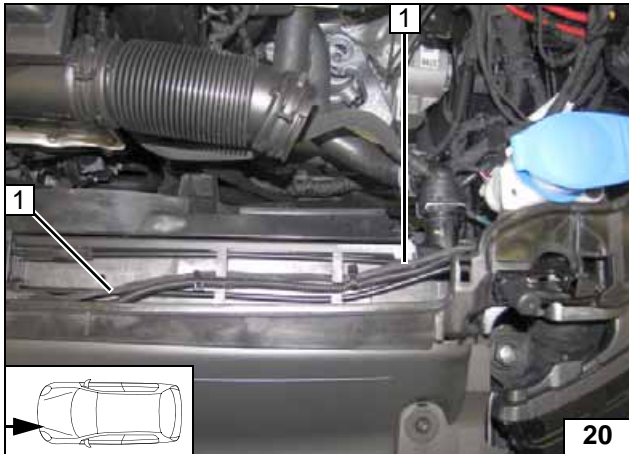

Route wiring harness of heater 1 with cable tie on original vehicle wiring harness to the installation location of the heater.

**Wiring Har-
ness Rout-
ing**

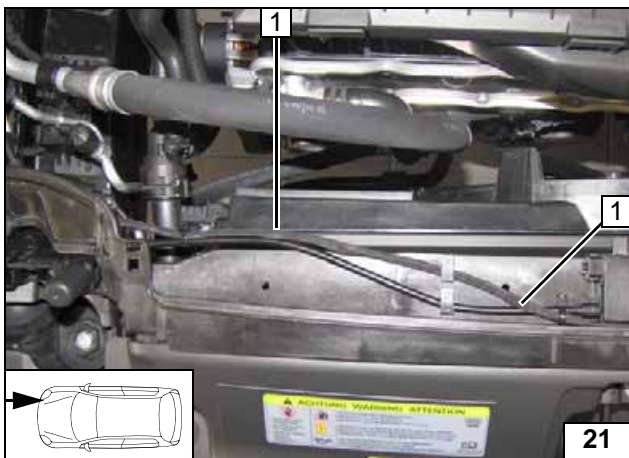

1 Wiring harness of heater

**Wiring Har-
ness Rout-
ing**



Variant A

Route wiring harnesses of heater and heater control 1 in original vehicle line duct to the firewall.



**Wiring Har-
ness Rout-
ing**

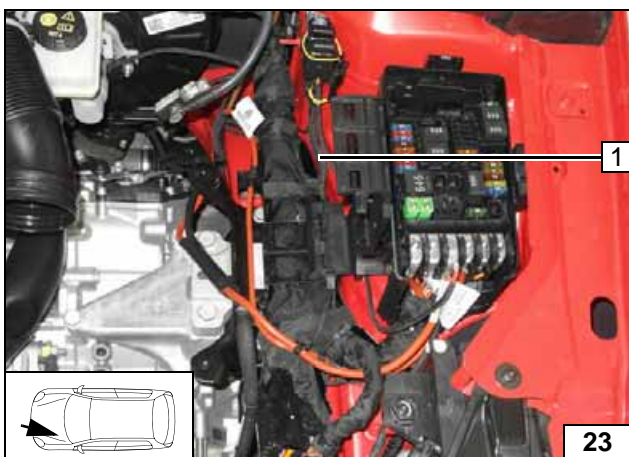

Variant B

Route wiring harnesses of heater and heater control 1 in original vehicle line duct to the firewall.



**Wiring Har-
ness Rout-
ing**



Fan Controller

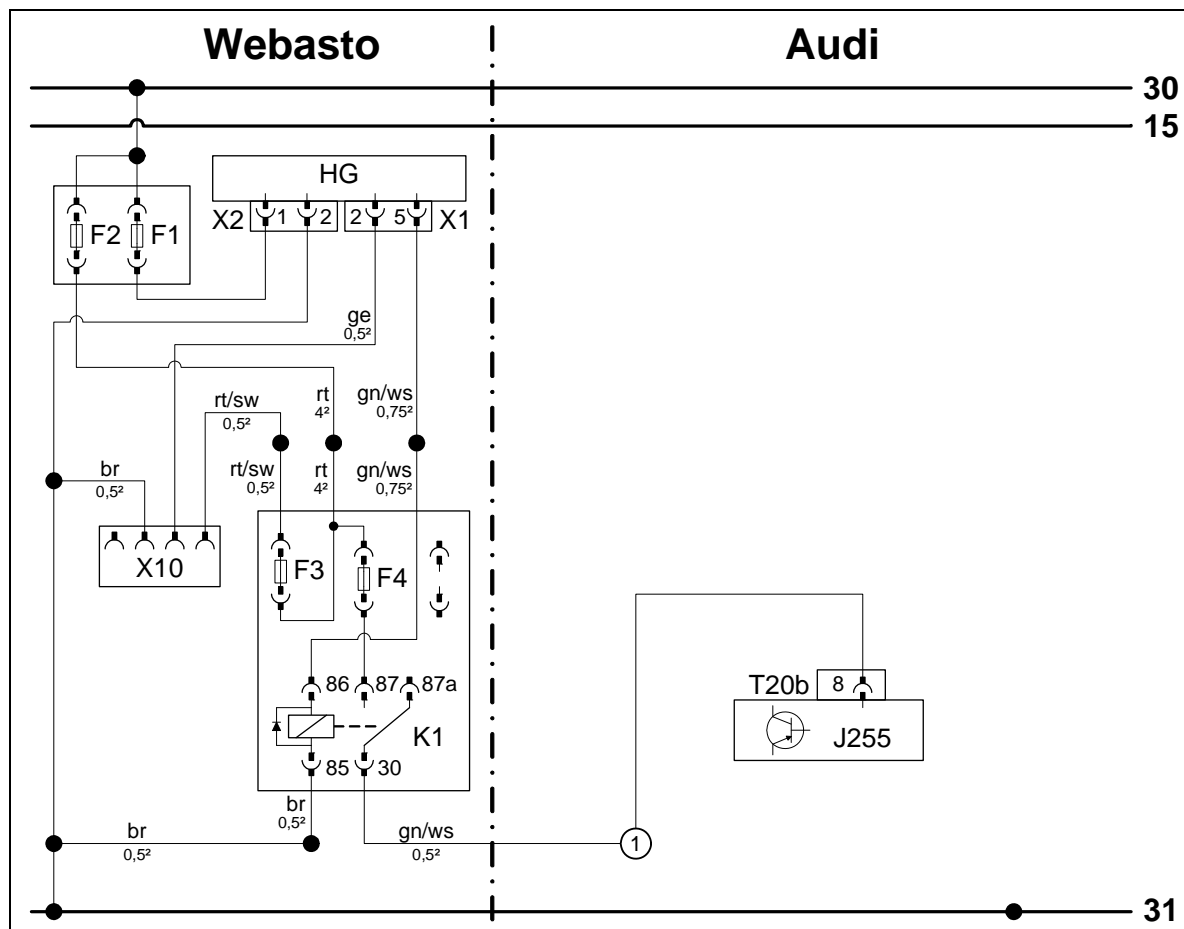

Wiring diagram

Webasto components		Vehicle components		Colours and symbols	
HG	Heater TT-Evo	T20b	20-pin connector J255	rt	red
X1	6-pin heater connector	J255	A/C control unit	sw	black
X2	2-pin heater connector			ge	yellow
X10	4-pin connector Heater control			gn	green
K1	Fan relay			br	brown
F1	Fuse 20A			ws	white
F2	Fuse 30A				
F3	Fuse 1A			X	Cutting point
F4	Fuse 1A			Wiring colours may vary.	

Legend

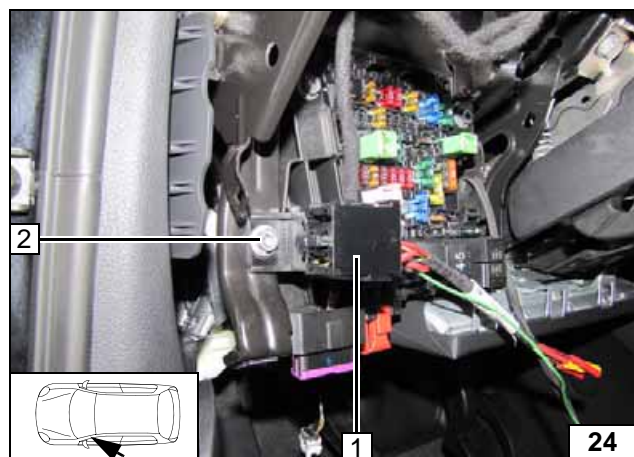

- 1 Relay and fuse holder of passenger compartment
- 2 Original vehicle bolt

Installing relay and fuse holder of passenger compartment

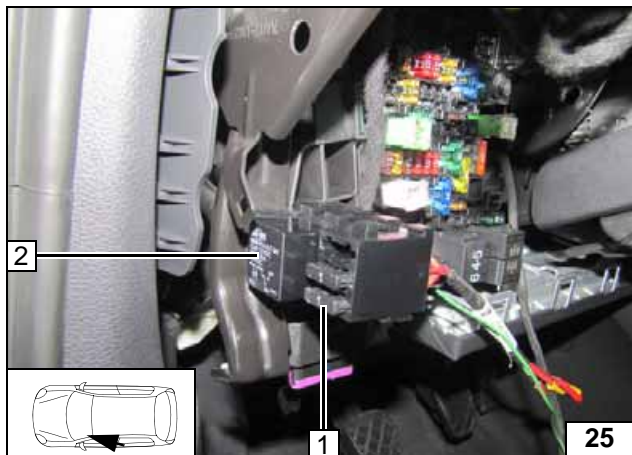

- 1 1A fuse F4
- 2 K1 relay

Installing K1 relay and fuse F4

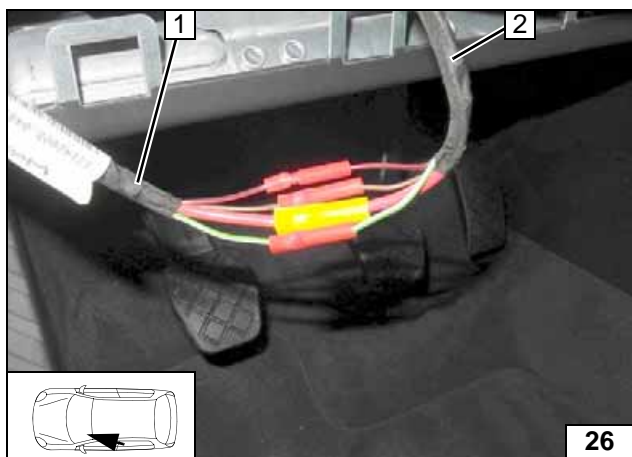

- 1 Wiring harness of passenger compartment relay and fuse holder
- 2 Wiring harness of heater

Connecting same colour wires of wiring harnesses

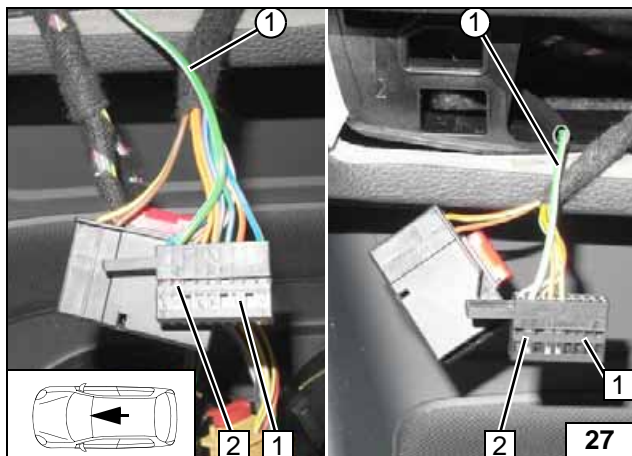

Image on the left shows Climatronic. Image on the right shows Climatic. Detach 20-pin connector 1 from A/C control unit and dismantle. Crimp socket contact on green/white (gn/ws) wire ① and insert it into free socket 2, Pin 8.



Connection of A/C control unit

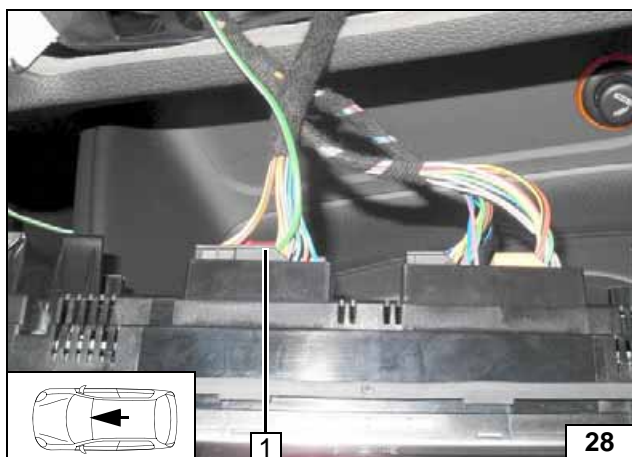
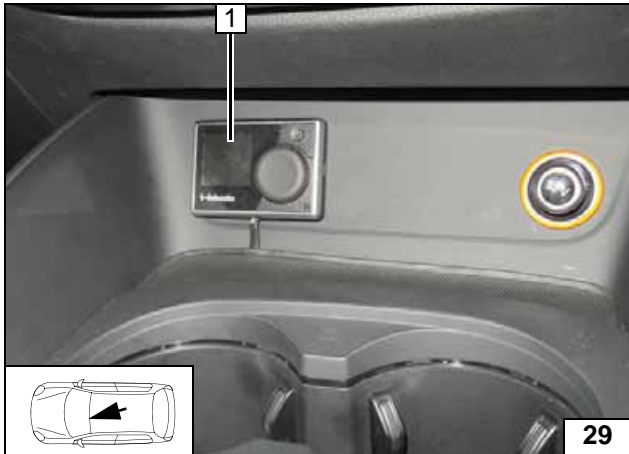

Image shows Climatronic. Complete 20-pin connector 1 and insert it.



Completing A/C control unit



MultiControl CAR Option

1 MultiControl CAR



Installing MultiControl CAR

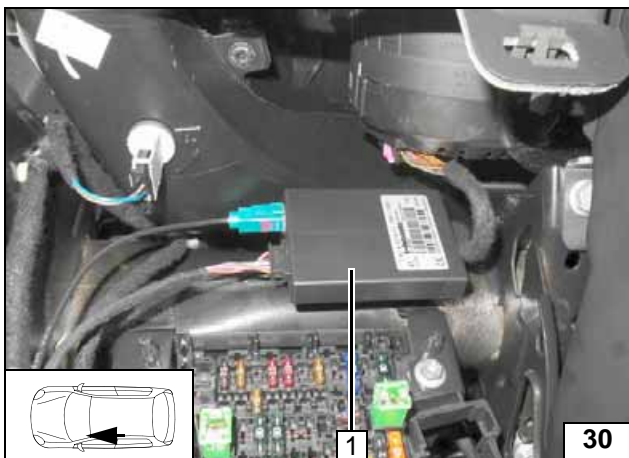

Remote Option (Telestart)

Fasten receiver 1 with adhesive tape.



Installing receiver

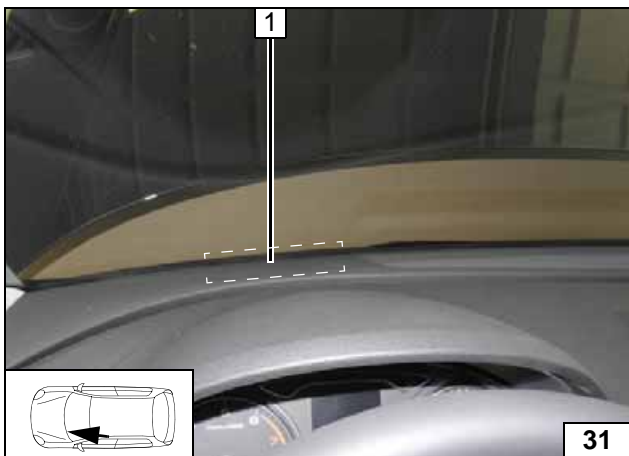

Glue antenna 1 onto the windscreen in the area of the marking.



Installing antenna

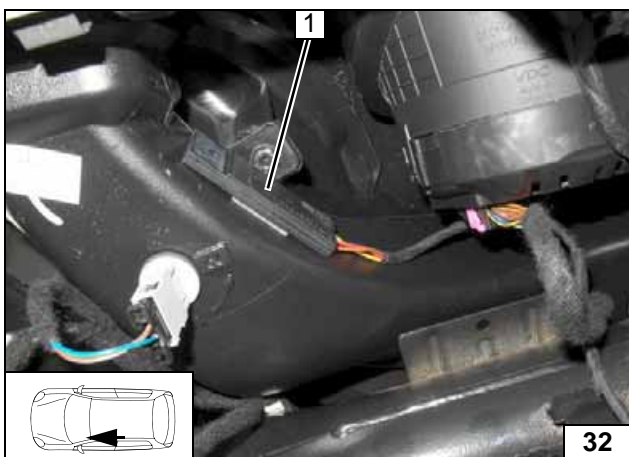

Temperature sensor T100 HTM

Fasten temperature sensor 1 with adhesive tape.



Installing temperature sensor

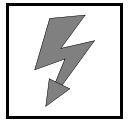

Remote Option (Thermo Call)

- 1 M5x20 bolt, large diameter washer, flanged nut, existing hole

Installing receiver

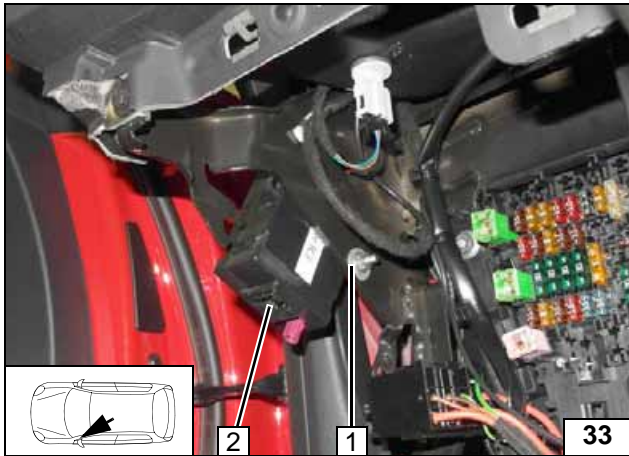

Glue antenna 1 onto the windscreen in the area of the marking.



Installing antenna

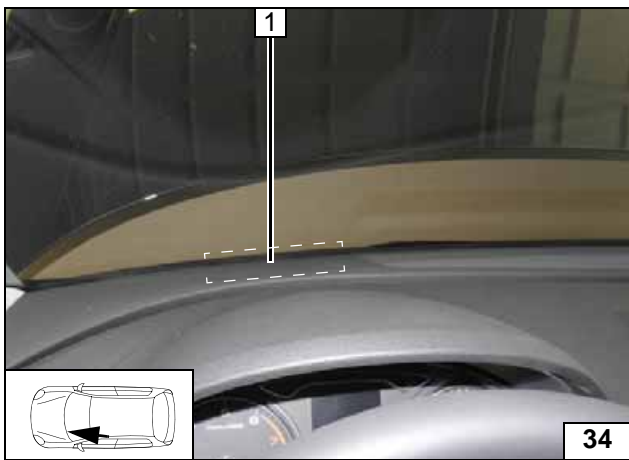

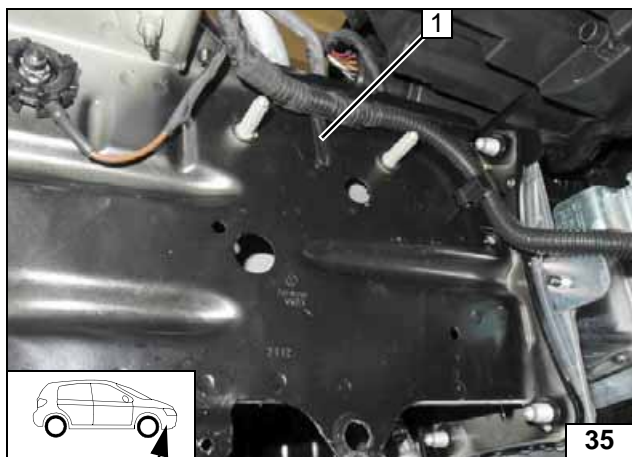

Preparing Installation Location

Remove retaining clip 1 from original vehicle wiring harness and discard it.



Removing retaining clip

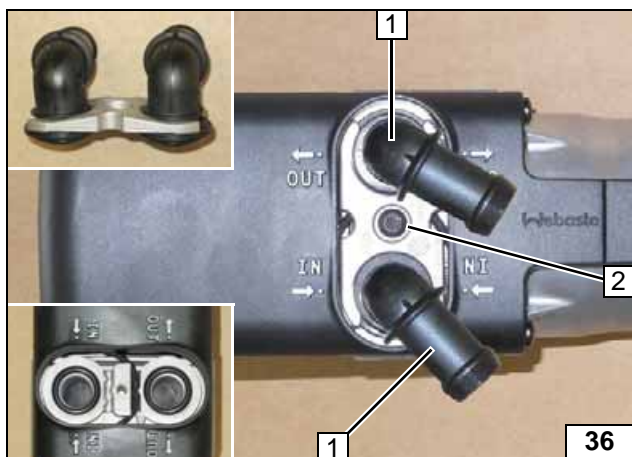

Preparing Heater

- 1 Water connection piece, sealing ring [2x each]
- 2 Self-tapping bolt 5x15, retaining plate, water connection piece



Assembling water connection piece

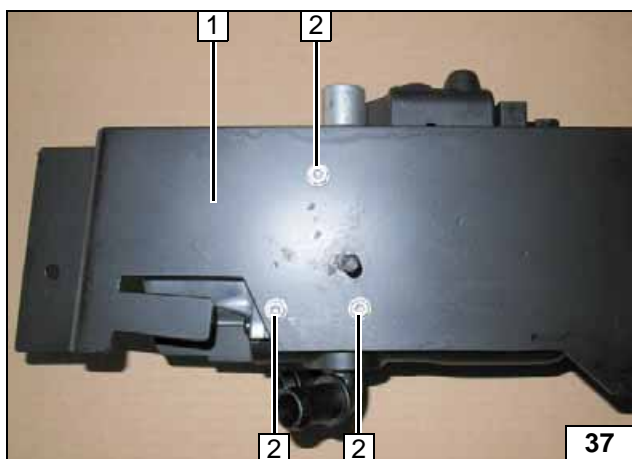

- 1 Bracket
- 2 Self-tapping bolt 5x13 [3x]

Installing bracket

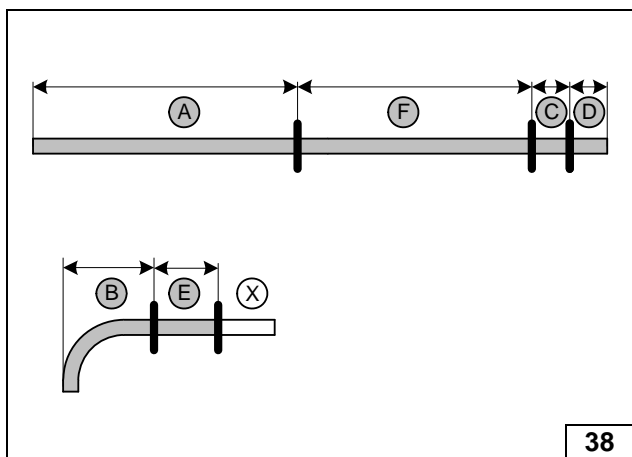

1.4 and 1.8 TFSI

Discard section X.
Hose B/E = 18mm dia. 90° moulded hose



Cutting hoses to length

	1.4 TFSI	1.8 TFSI
A =	1070	1000
B =	125	110
C =	60	60
D =	80	80
E =	110	110
F =	990	990

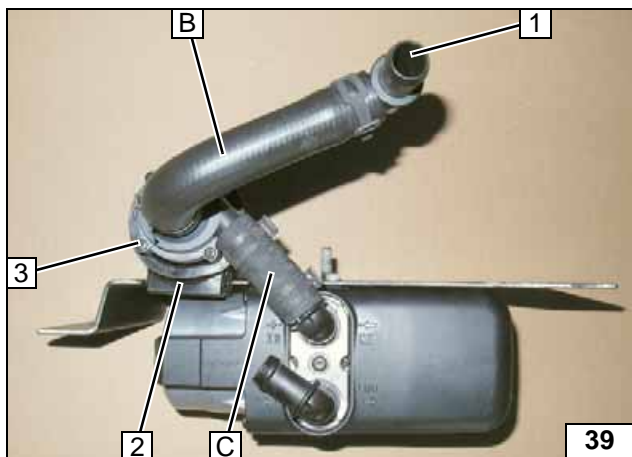

All spring clips = 25 mm dia.
Slide circulating pump mounting 2 onto tab of bracket.

- 1 90° connecting pipe
- 3 Circulating pump



Premounting hoses

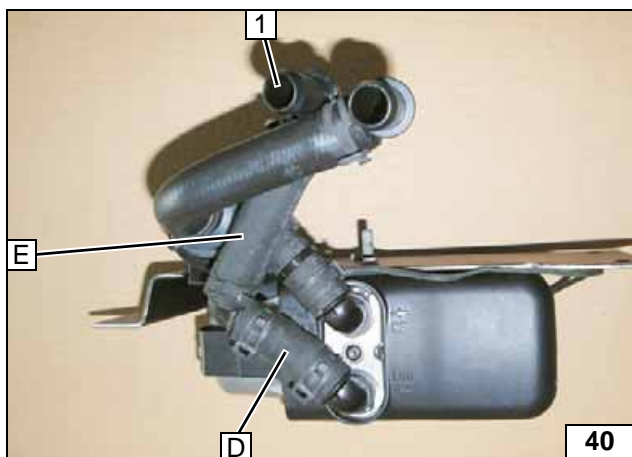

All spring clips = 25 mm dia.

- 1 90° connecting pipe



Premounting hoses

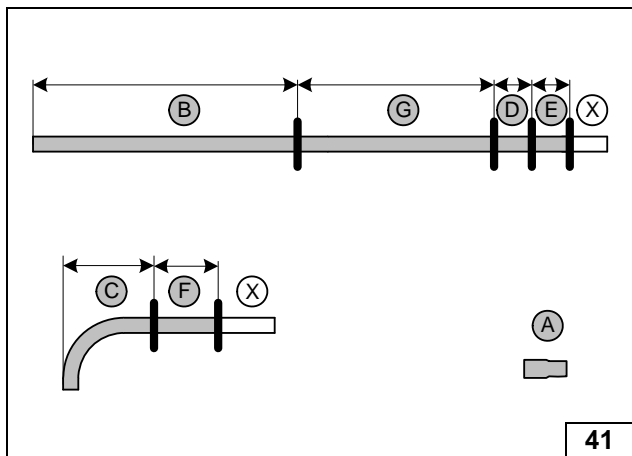

1.6 and 2.0 TDI

Discard section X.
Hose A = 18x20 mm dia. straight moulded hose
Hose C/F = 90°, 18mm dia. moulded hose

- B = 1020
- C = 125
- D = 80
- E = 60
- F = 110
- G = 980



Cutting hoses to length

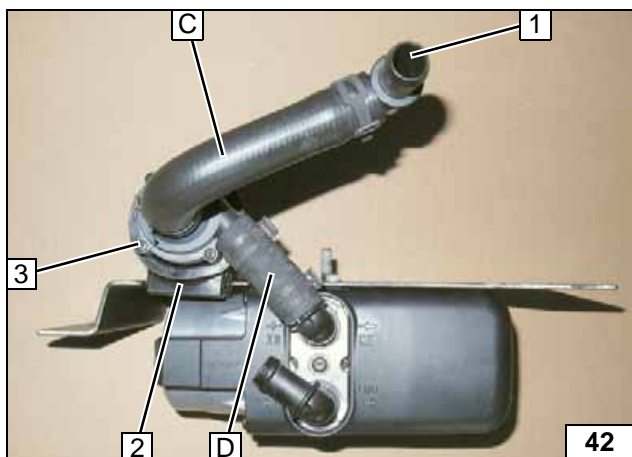

All spring clips = 25 mm dia.
Slide circulating pump mounting 2 onto tab of bracket.

- 1 90° connecting pipe
- 3 Circulating pump



Premounting hoses

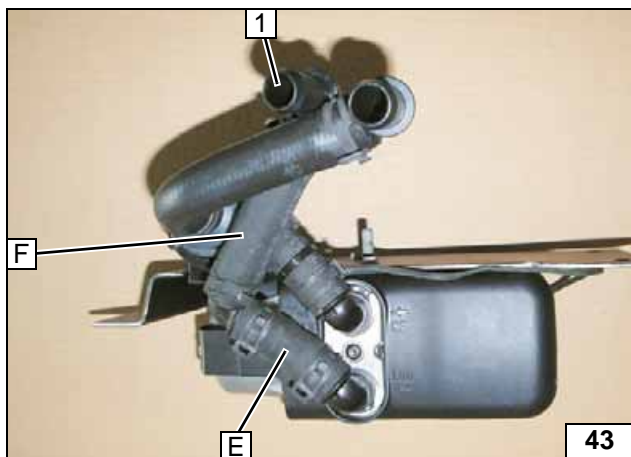

All spring clips = 25 mm dia.

- 1 90° connecting pipe



Premounting hoses

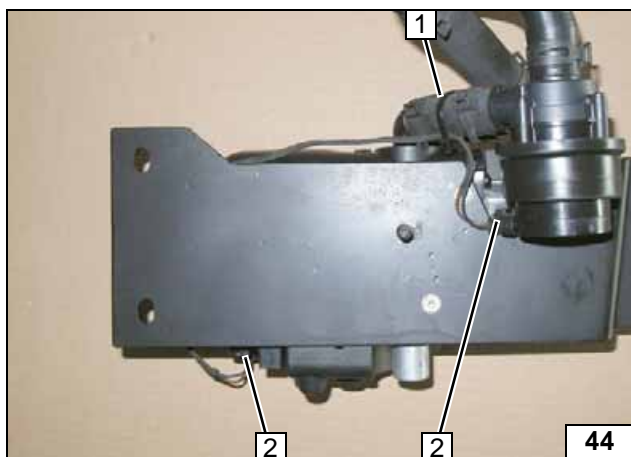

All vehicles

- 1 Cable tie
- 2 Connector of circulating pump wiring harness [2x]

Installing wiring harness

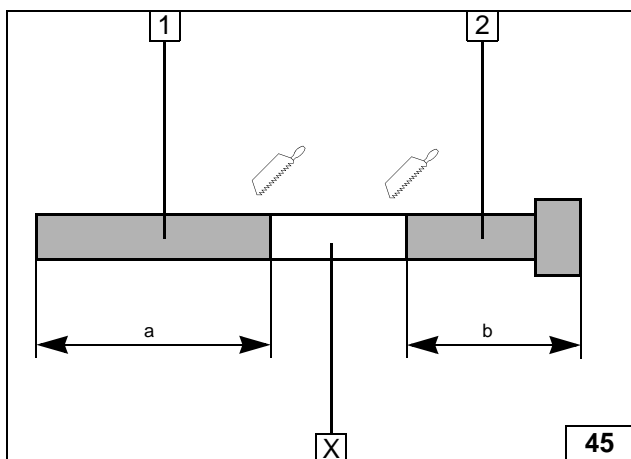

Discard section X.

- 1 Exhaust pipe
- 2 Exhaust end section



Preparing exhaust pipe

	1.4 TFSI / TDI	1.8 TFSI
a =	195	210
b =	80	90

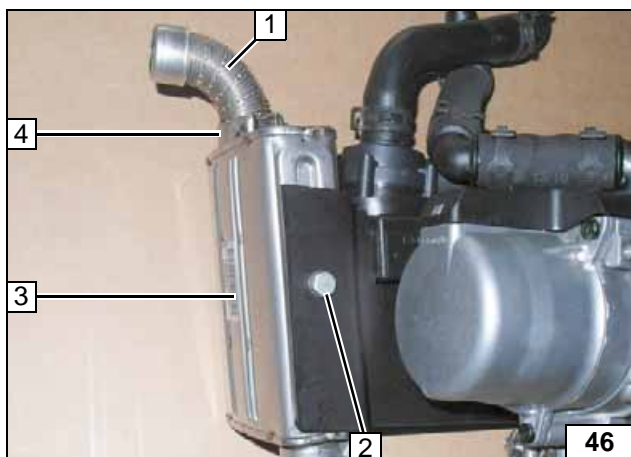

Only 1.4 TFSI / TDI

- 1 Exhaust end section
- 2 M6x16 bolt, spring lockwasher
- 3 Silencer
- 4 Hose clamp

Installing silencer and exhaust end section

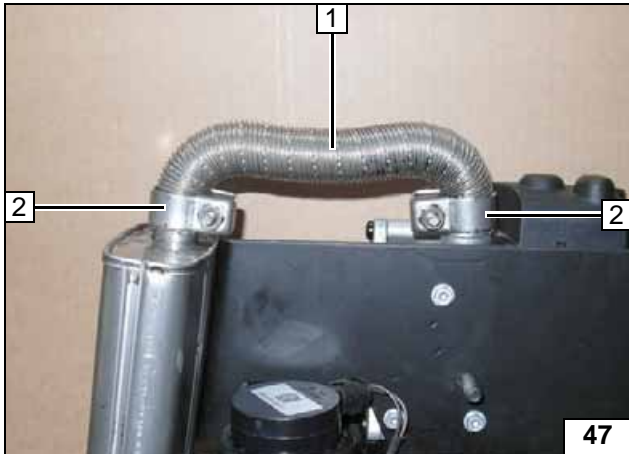

- 1 Exhaust pipe
- 2 Hose clamp [2x]

Installing exhaust pipe

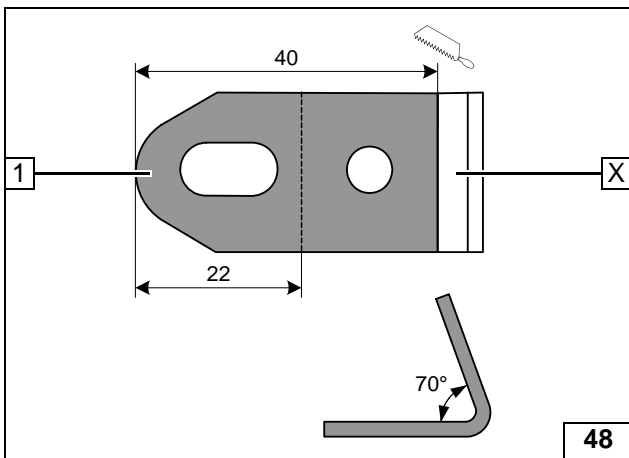

Only 1.8 TFSI

Discard section X.

- 1 Angle bracket



Preparing angle bracket

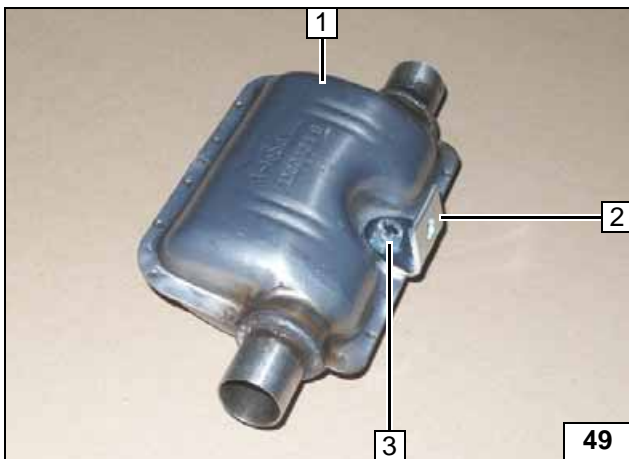

- 1 Silencer
- 2 Angle bracket
- 3 M6x16 bolt, flanged nut

Premounting silencer



- 1 Exhaust end section
- 2 Hose clamp
- 3 M6x12 bolt, flanged nut
- 4 Bracket of heater

Installing silencer / exhaust end section

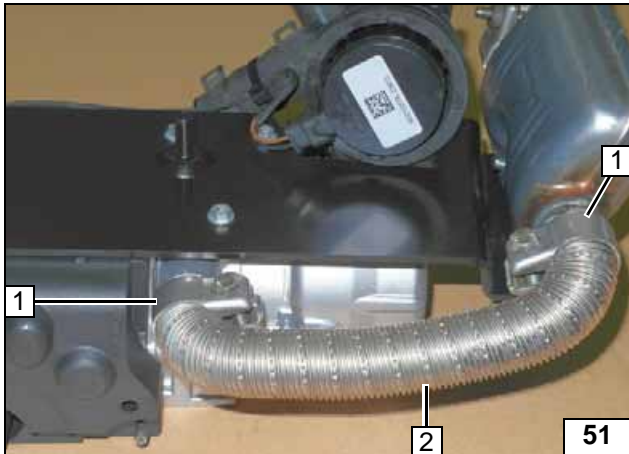

- 1 Hose clamp [2x]
- 2 Exhaust pipe

Installing exhaust pipe

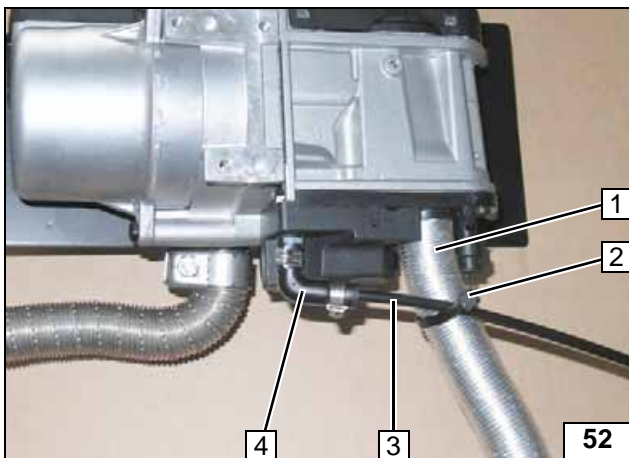

All vehicles

Shorten combustion air pipe 1 to 320mm.

- 2 Cable tie
- 3 Fuel line
- 4 90° short moulded hose, 10 mm dia. clamp [2x]



Premounting combustion air pipe and fuel line

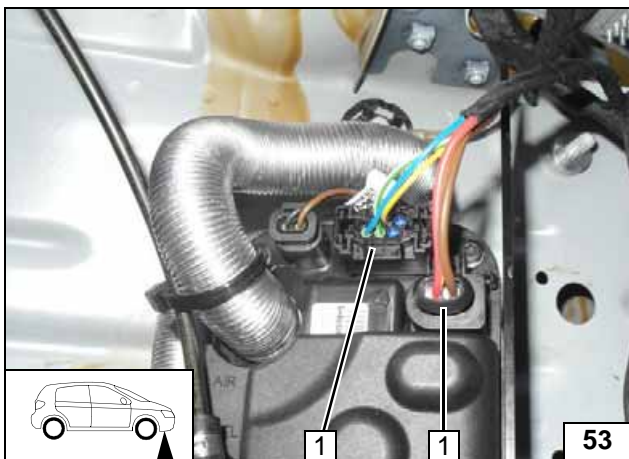

Installing Heater

- 1 Heater wiring harness connector [2x]

Installing wiring harness

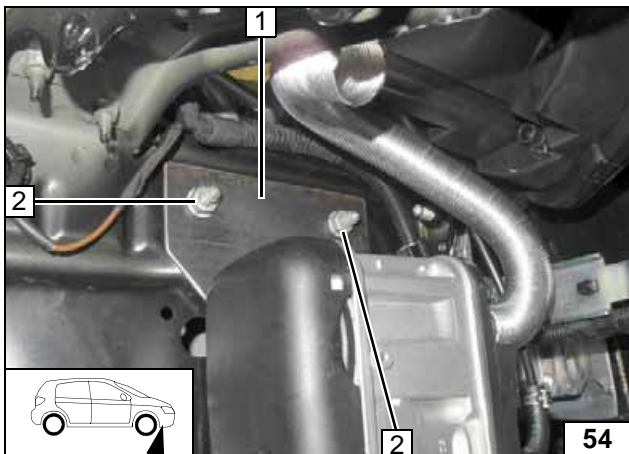

Insert one 5 mm shim each between bracket 1 and frame side member.

- 2 Original vehicle stud bolt, 5 mm shim, M8 flanged nut [2x each]



Installing Heater

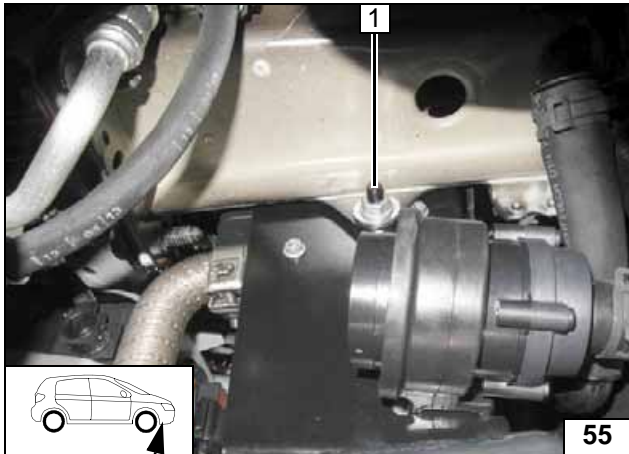
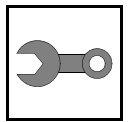

- 1 Stud bolt of bracket, large diameter washer, M8 flanged nut



**Installing
Heater**

Audi A3 / A3 Convertible



Fuel

CAUTION!

Open the vehicle's fuel tank cap, ventilate the tank and then re-close the tank lock.

Catch any fuel running off in an appropriate container.

Install fuel line and metering pump wiring harness so that they are protected against stone impact. Unless specified otherwise, always fasten using cable ties. Provide rub protection for fuel line and wiring harness in areas where there are sharp edges.

WARNING!

The fuel line and wiring harness are routed to the metering pump as shown in the wiring harness routing diagram.



Installing lines



Shorten 10mm dia. corrugated tube by 1200mm. Pull fuel line and wiring harness of the metering pump into 10mm dia., 1200mm long corrugated tube 1 and route it to the engine compartment.

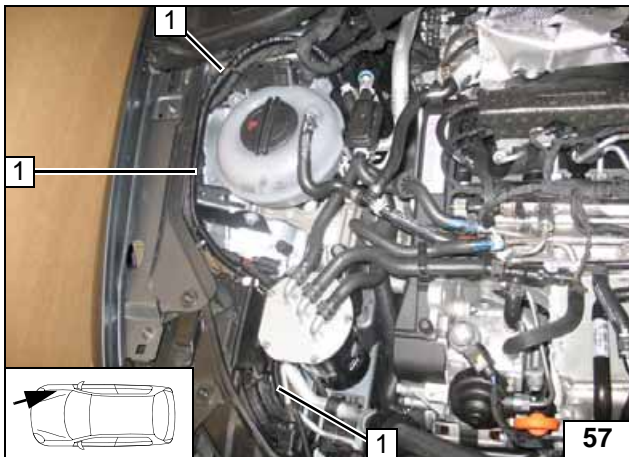

Route fuel line and wiring harness of metering pump in corrugated tube 1 to the firewall on original vehicle lines.



Installing lines

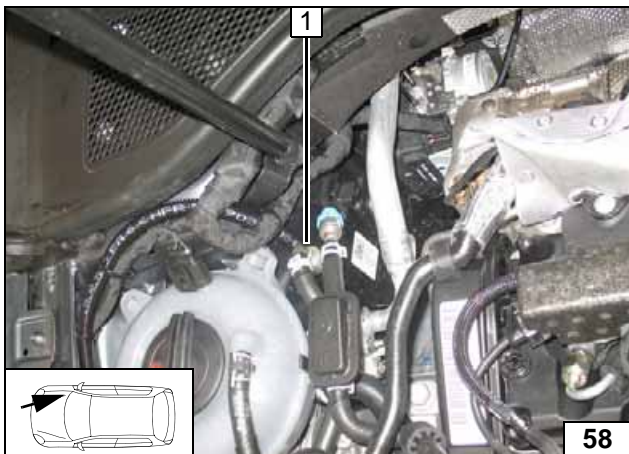

Route fuel line and wiring harness of metering pump in original vehicle line duct 1 to the underbody.



Installing lines

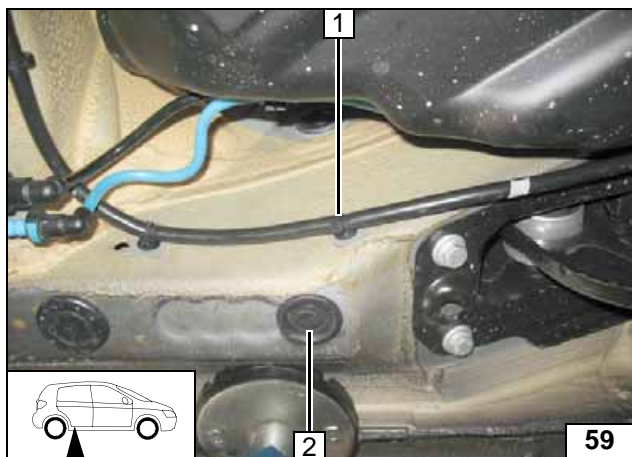

Remove cover cap 2. When a 2 piece plug is available at position 2, remove it according to following image.
Cover cap 2 and 2 piece plug will be re-installed later.



- 1 Remove retaining clip from hole

Preparing installation location of metering pump

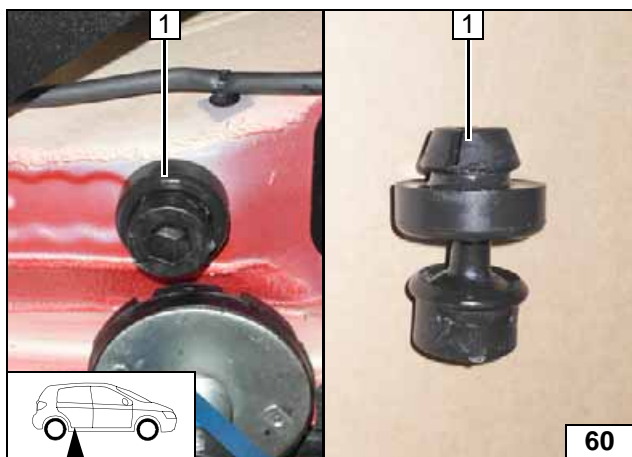

- 1 2 piece plug

Removing plug

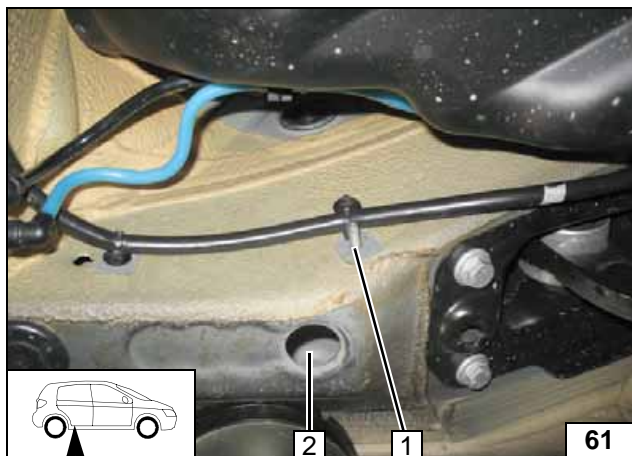

All vehicles

Insert M6x20 bolt 1 into hole through assembly opening 2.



Preparing installation location of metering pump

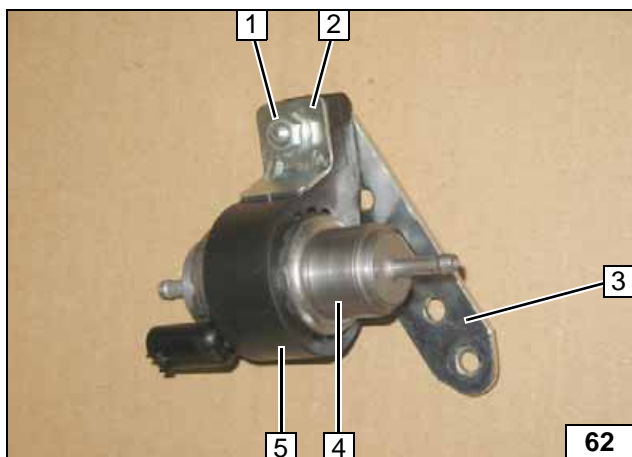

- 1 M6x25 bolt, flanged nut
- 2 Support angle bracket
- 3 Perforated bracket
- 4 Metering pump
- 5 Mounting of metering pump

Premounting metering pump

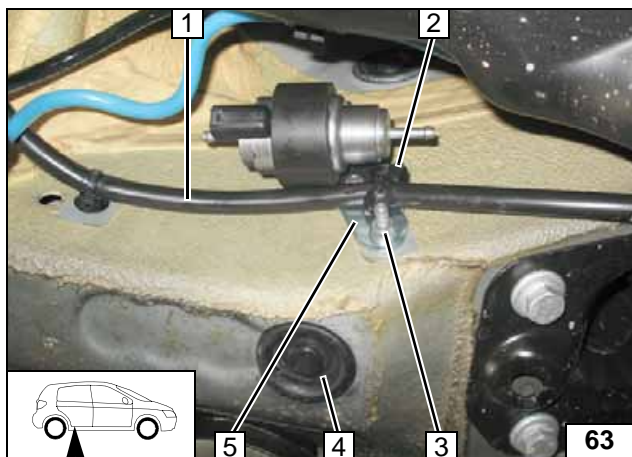

Fasten original vehicle wiring harness 1 using cable tie 2 to perforated bracket 5 . Re-install lifting platform on vehicles with lifting platform mounting

- 3 M6 flanged nut
- 4 Mount cover cap or plug

Installing metering pump

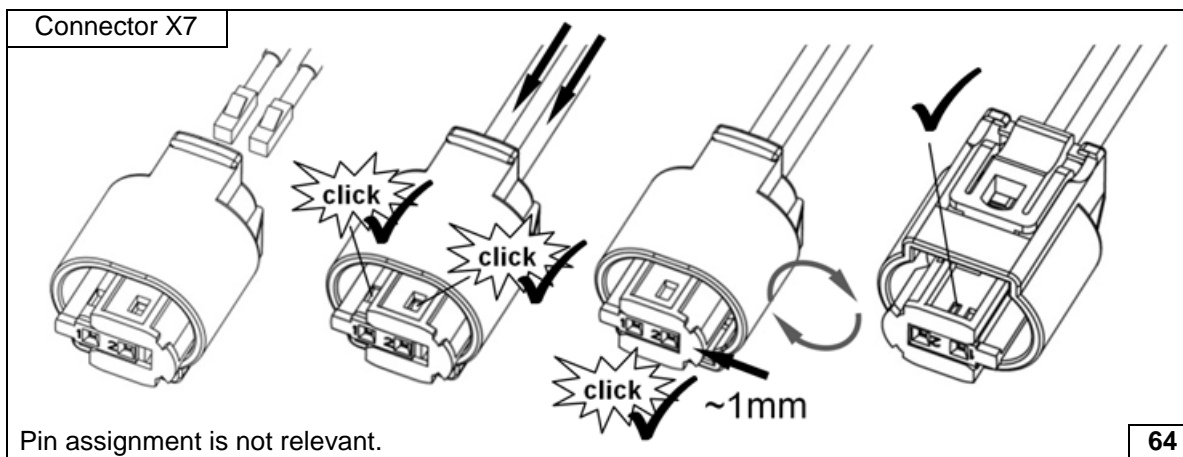

Completing connector of metering pump

Pin assignment is not relevant.

64

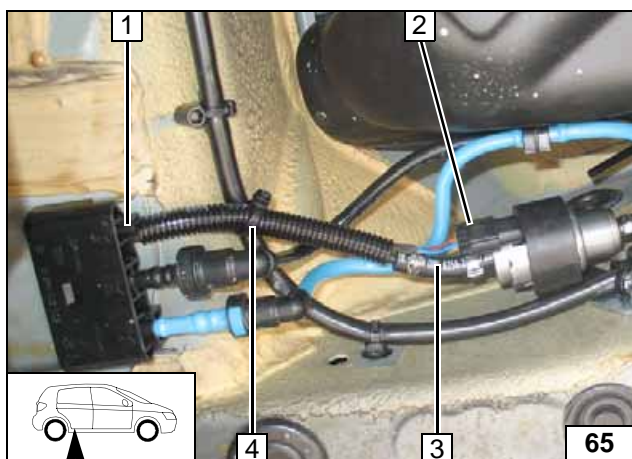

Shorten 10mm dia. corrugated tube by 130mm. Route fuel line and wiring harness of metering pump of original vehicle pass through 1 and pull them into 130mm corrugated tube.

- 2 Wiring harness of metering pump, connector X7 mounted
- 3 Fuel line of heater, hose section, 10mm dia. clamp [2x]
- 4 Cable tie

Connecting metering pump

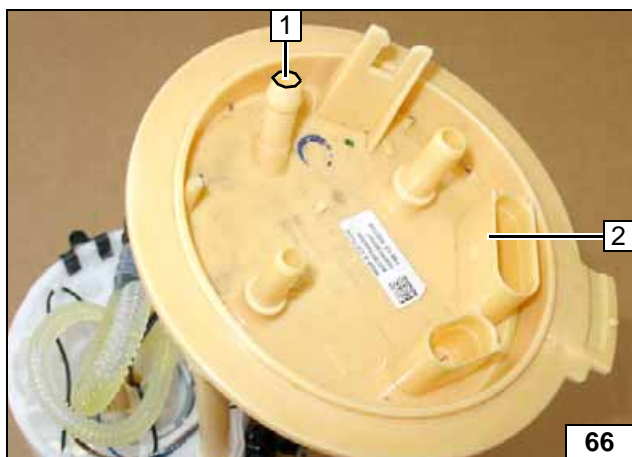

Version 1

Remove fuel-tank sending unit 2 in accordance with manufacturer's instructions. Cut off the tip of connection piece 1 using the appropriate tools. Warning, risk of breakage!

Fuel extraction



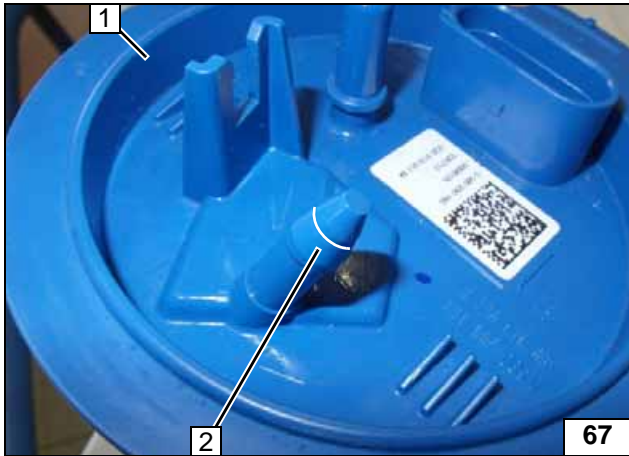
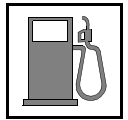

Version 2

Remove fuel-tank sending unit 1 in accordance with manufacturer's instructions. Cut off the tip of connection piece 2 along the perforation using the appropriate tools. Warning, risk of breakage!



Fuel extraction

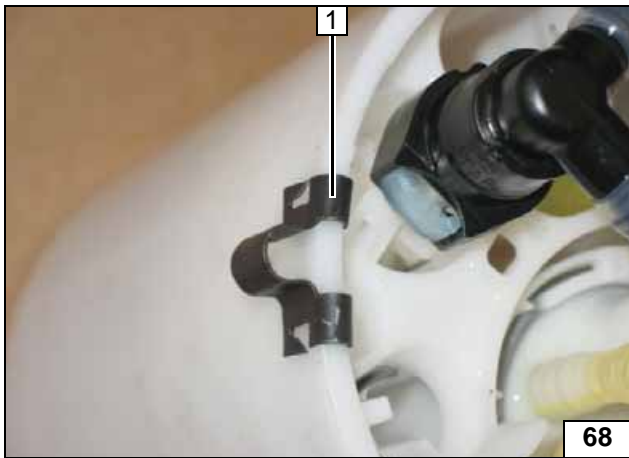

All vehicles

Slightly bend open retaining clamp 1 and insert it into fuel-tank sending unit.



Inserting retaining clamp

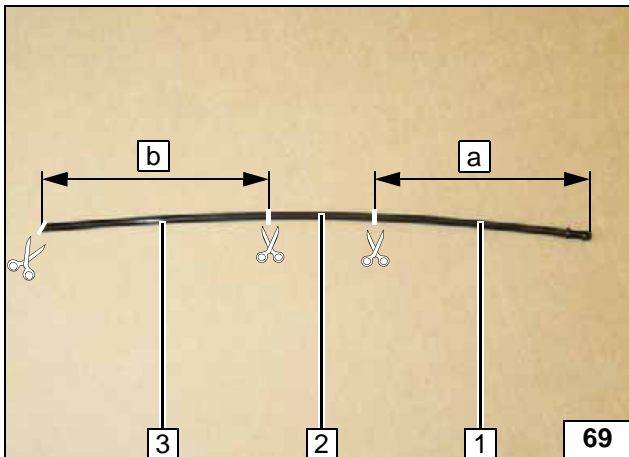

Obliquely cut off standpipe B 3 at the end.

- 1 Standpipe A
- 2 Discard section



Cutting standpipes to length

	TFSI	TDI
a =	120	145
b =	130	140

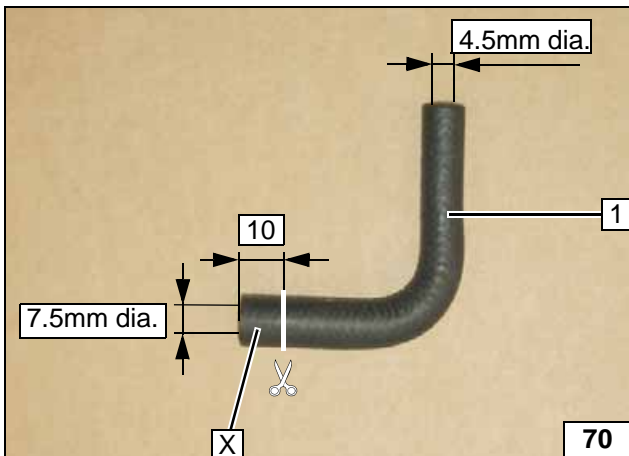

Discard section X.

- 1 90° moulded hose with inner dia. $d_i = 4.5 \times 7.5 \text{mm}$



Cutting moulded hose to length

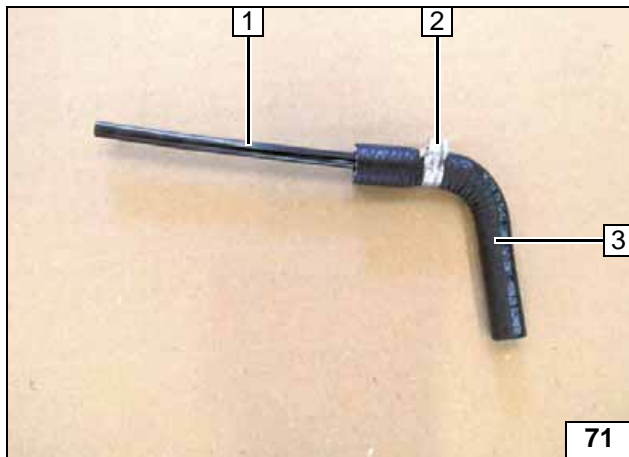

- 1 Standpipe A
- 2 10 mm dia. clamp
- 3 90° moulded hose with inner dia. $d_i = 4.5 \times 7.5 \text{ mm}$

Premounting moulded hose

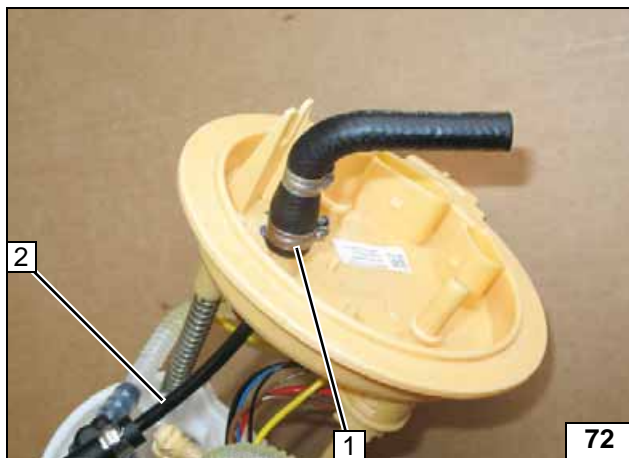

- 1 13.5mm dia. clamp
- 2 Standpipe A

Mounting standpipe A

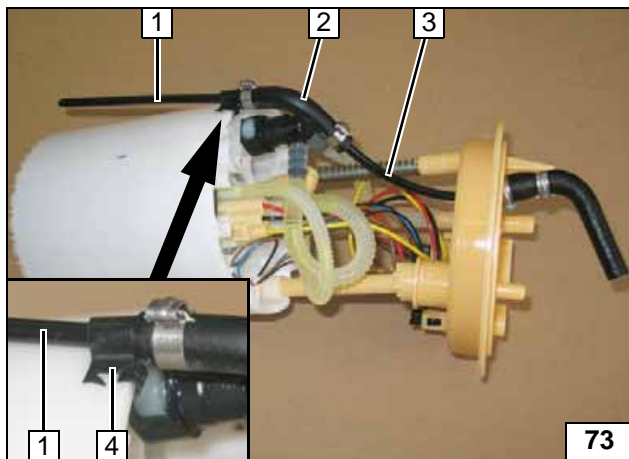

Version 1

Route standpipe B 1 through retaining clamp 4.

- 2 90° moulded hose, 10mm dia. clamp [2x]
- 3 Standpipe A

Mounting standpipe B

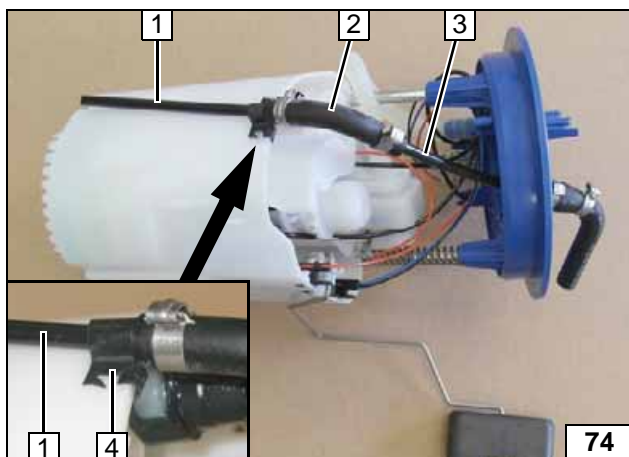

Version 2

Route standpipe B 1 through retaining clamp 4.

- 2 90° moulded hose, 10mm dia. clamp [2x]
- 3 Standpipe A

Mounting standpipe B

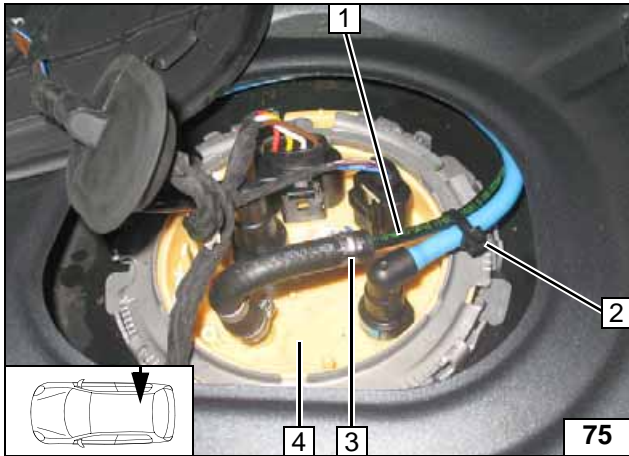
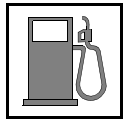

All vehicles

Figure shows TDI.
Install fuel-tank sending unit **4** in accordance with manufacturer's instructions.

- 1** Fuel line
- 2** Cable tie
- 3** 10 mm dia. clamp



**Connect-
ing fuel line**

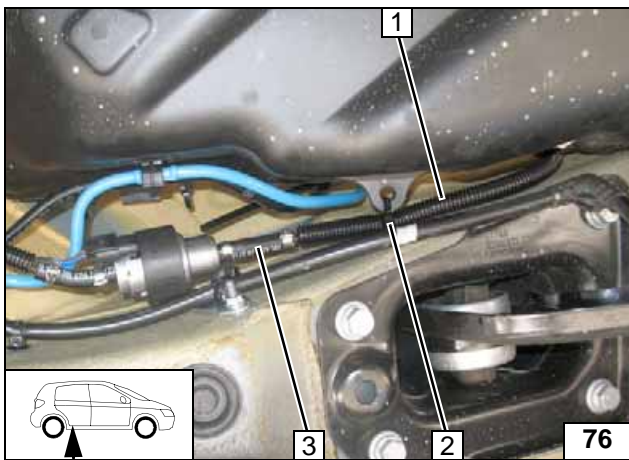

Slide 10mm dia. corrugated tube **1** onto fuel line. Check the position of the components; adjust if necessary. Check that they have freedom of movement.

- 2** Cable tie
- 3** Fuel line, hose section, 10 mm dia. clamp [2x]



**Connect-
ing meter-
ing pump**

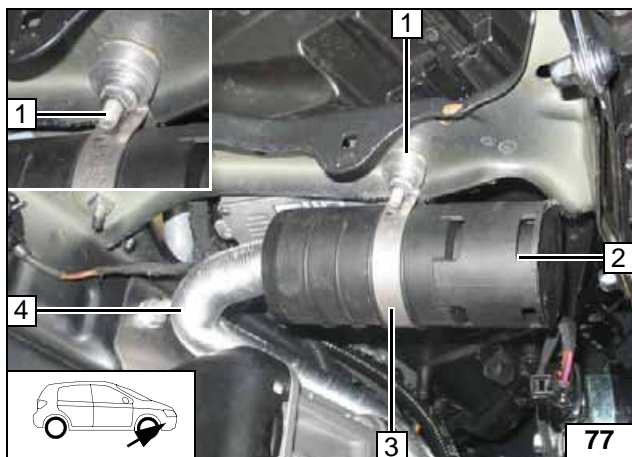
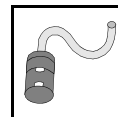

Combustion Air

- 1 M5x25 bolt, large diameter washer, 10mm shim, flanged nut, existing hole
- 2 Silencer
- 3 51mm dia. clamp
- 4 Combustion air pipe



**Installing
silencer**



Coolant Circuit FSI



WARNING!

Any coolant running off should be collected using an appropriate container. Install hoses so that they are kink-free. Unless specified otherwise, always fasten using cable ties. Position clamps so that other hoses cannot be damaged. The heater must be filled with coolant when installing the hoses. The connection should be modelled on an "inline" circuit and based on the following diagram:

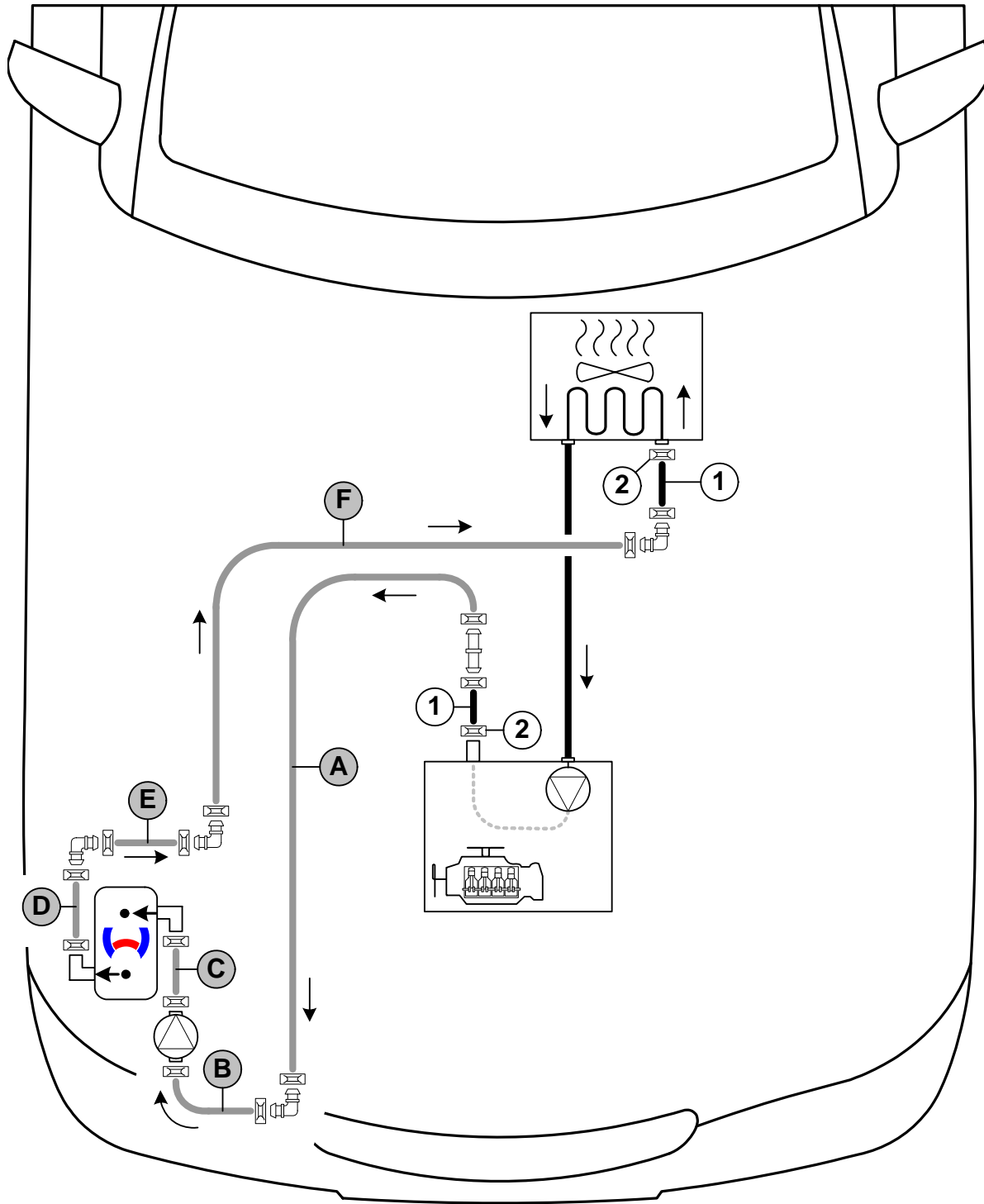



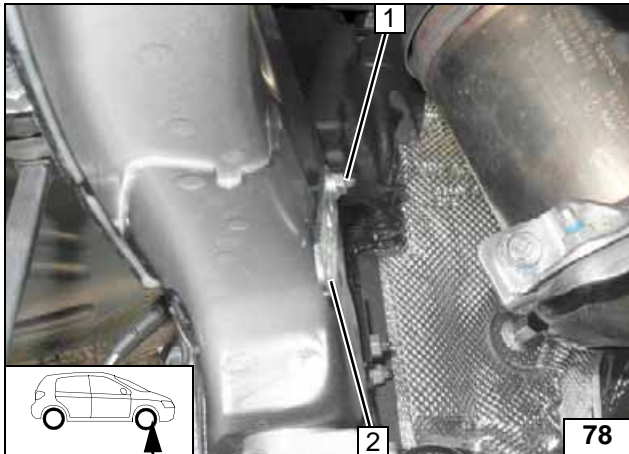

Diagram of hose routing

All spring clips without a specific designation  = 25 mm dia. **2** = Original vehicle spring clip . **1** = Original vehicle hose. All connecting pipes  and  = 18x18 mm dia.





- 1 M6 flanged nut, original vehicle stud bolt
- 2 Perforated bracket

Installing perforated bracket

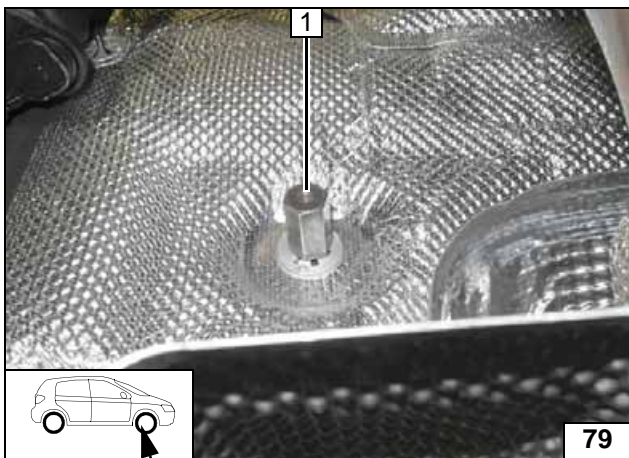

- 1 M6x30 spacer nut, original vehicle stud bolt

Installing spacer nut

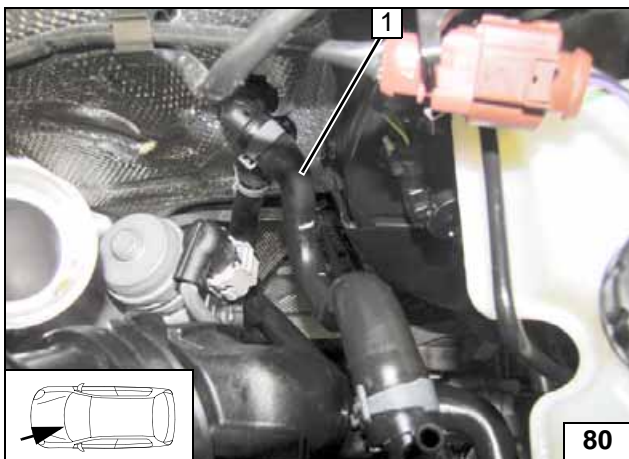

1.4 TFSI

Remove hose 1 from engine outlet/heat exchanger inlet. Spring clips will be reused.



Cutting point

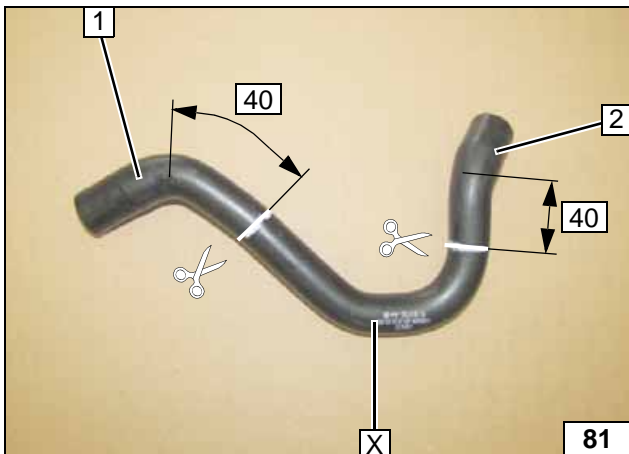

Discard section X.

- 1 Hose section on engine outlet
- 2 Hose section on heat exchanger inlet



Cutting point

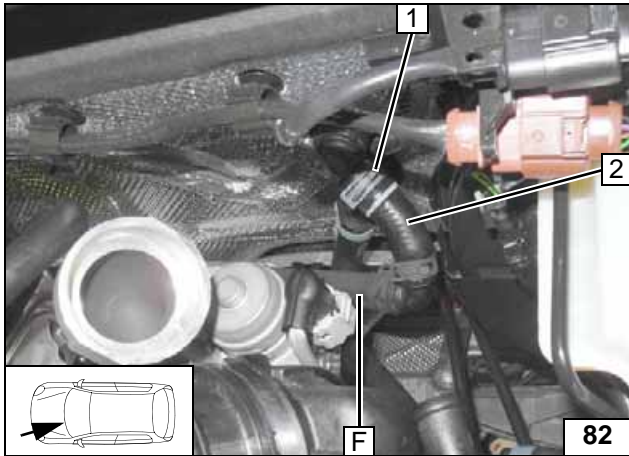

- 1 Original vehicle spring clip
- 2 Hose section on heat exchanger inlet

Connect-
ing heat ex-
changer
inlet

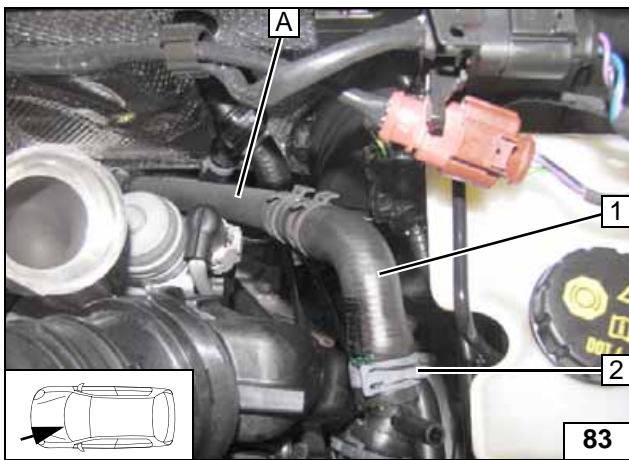

- 1 Hose on engine outlet
- 2 Original vehicle spring clip

Connect-
ing engine
outlet

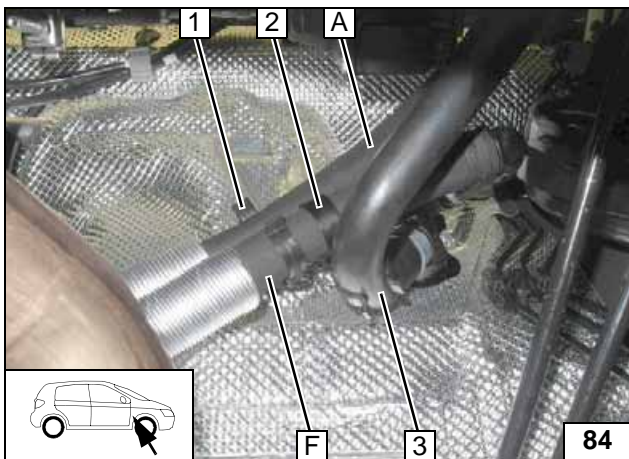

Push one 600mm long heat protection hose each onto hoses **A** and **F**!

- 1 Spacer bracket
- 2 Spacer bracket twistable
- 3 Hose on heat exchanger outlet



Routing on
firewall

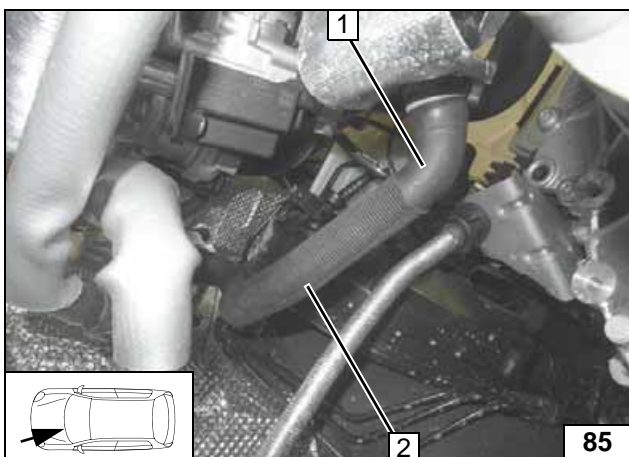

1.8 TFSI

Remove hose 1 from engine outlet/heat exchanger inlet. Spring clips will be reused. Remove rub protection 2.



Cutting
point

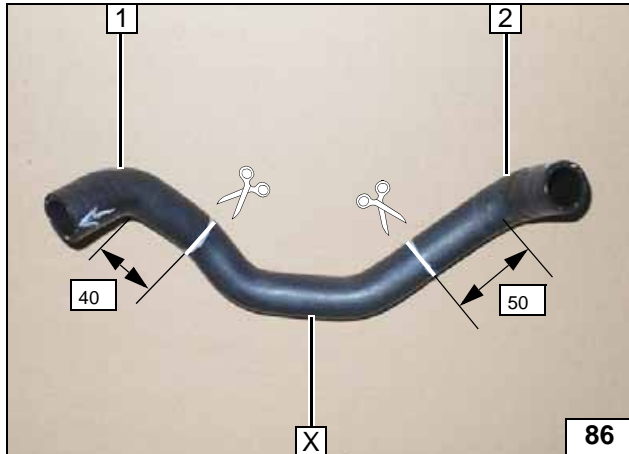

Discard section X.

- 1 Hose section on heat exchanger inlet
- 2 Hose section of engine inlet

Cutting point

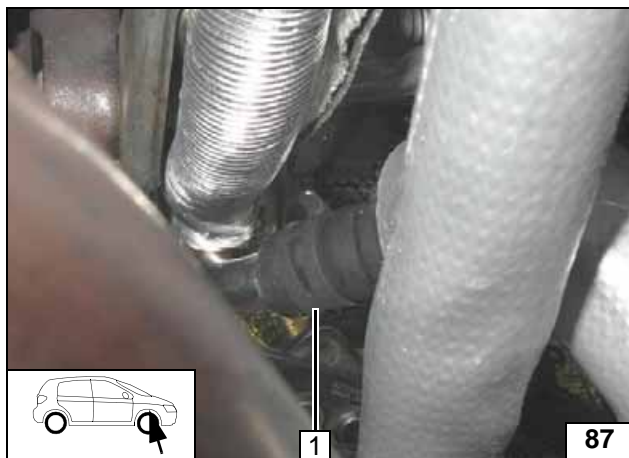

Rotate upper spring clip 1 from turbo hose/y-piece of heat exchanger outlet by 180° (see image for final position).



Connecting heat exchanger inlet

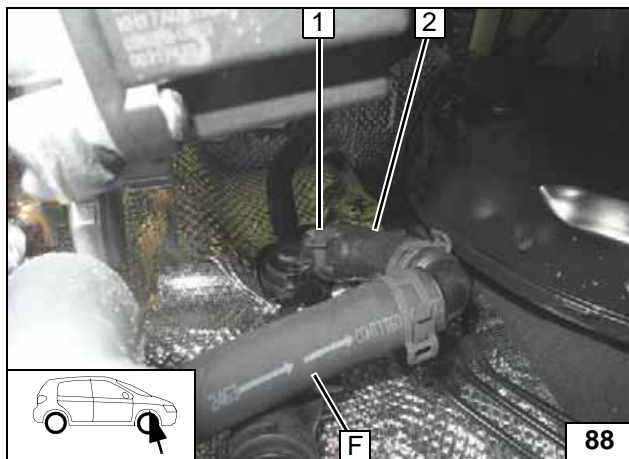

- 1 Original vehicle spring clip
- 2 Hose section on heat exchanger inlet

Connecting heat exchanger inlet

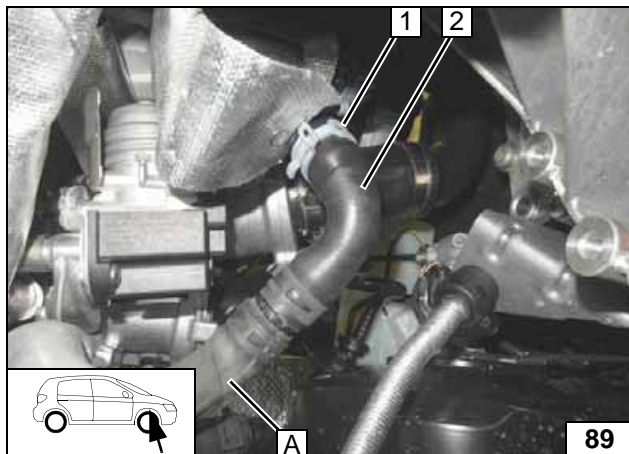

- 1 Original vehicle spring clip
- 2 Hose section on engine outlet

Connecting engine outlet

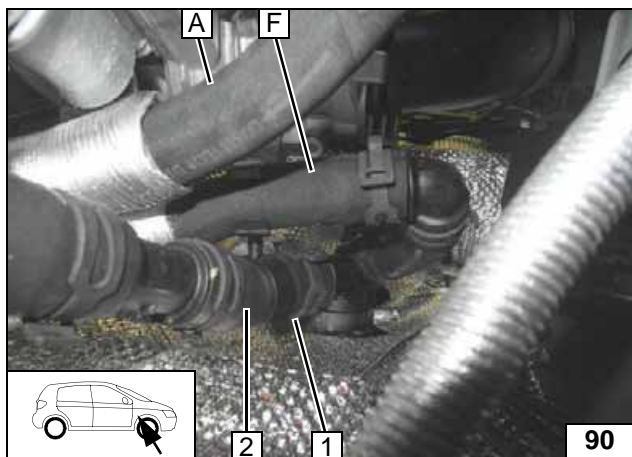

Push one 600mm long heat protection hose each onto hoses **A** and **F**!



- 1 Spacer bracket twistable
- 2 Hose on heat exchanger outlet

Routing on firewall

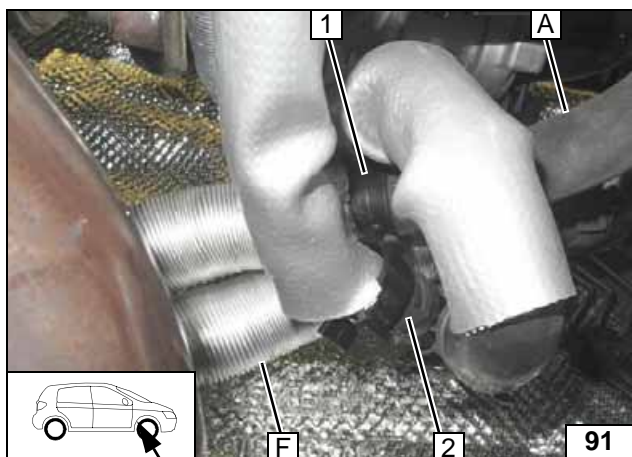

Align hose **A** and **F** and make sure there is sufficient distance to exhaust pipe.



- 1 Spacer bracket twistable
- 2 Original vehicle hose

Routing on firewall

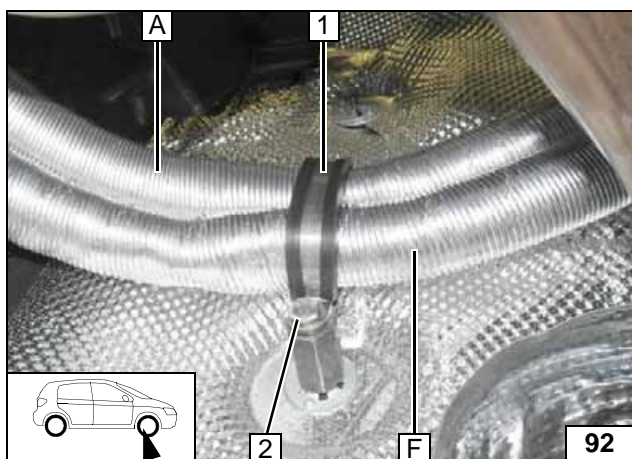

All vehicles

- 1 48 mm dia. rubber-coated p-clamp
- 2 M6x20 bolt, spring lockwasher

Fastening on firewall

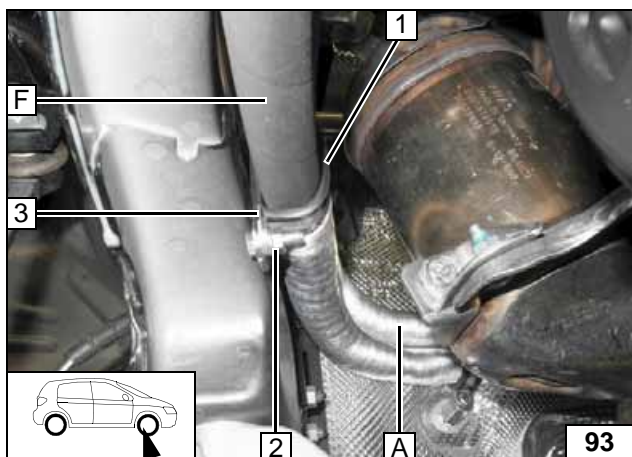

Align hoses. Ensure sufficient distance to catalytic converter, correct if necessary.



- 1 38 mm dia. rubber-coated p-clamp
- 2 M6x20 bolt, flanged nut
- 3 Perforated bracket

Routing on frame side member

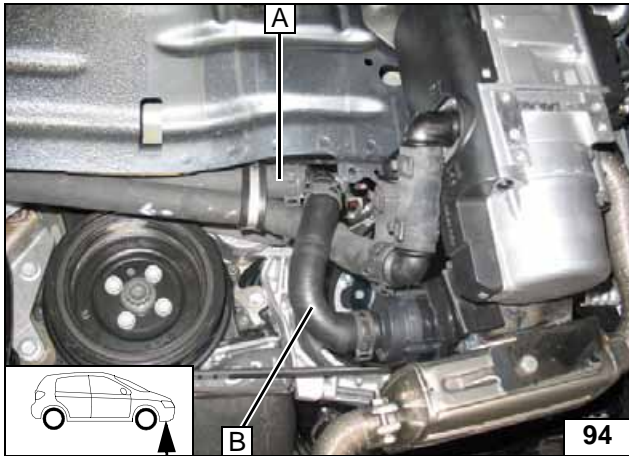

Connect-
ing heater
inlet

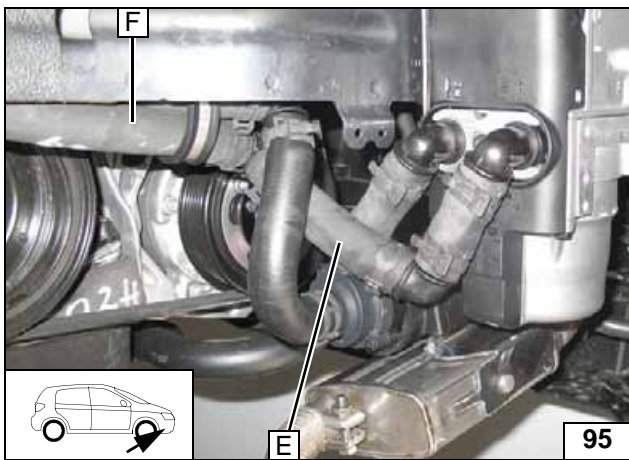

Connect-
ing heater
outlet

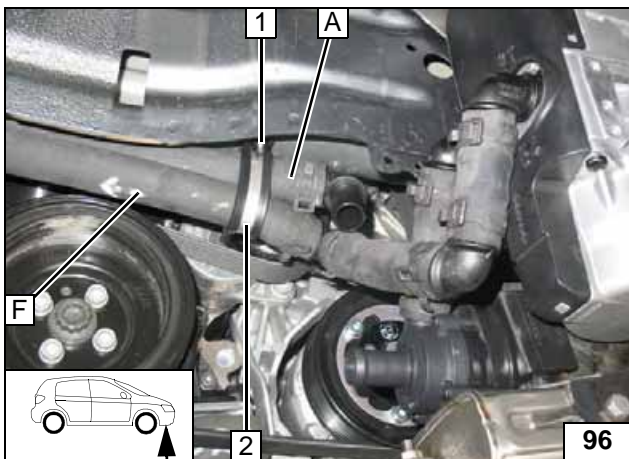

Hose **B** removed to improve depiction. En-
sure sufficient distance to neighbouring com-
ponents, adjust, if necessary.

- 1 Original vehicle stud bolt, plastic nut
- 2 38 mm dia. rubber-coated p-clamp



Aligning
and fasten-
ing hoses



Coolant Circuit TDI



WARNING!

Any coolant running off should be collected using an appropriate container. Install hoses so that they are kink-free. Unless specified otherwise, always fasten using cable ties. Position clamps so that other hoses cannot be damaged. The heater must be filled with coolant when installing the hoses. The connection should be "inline" based on the following diagram:

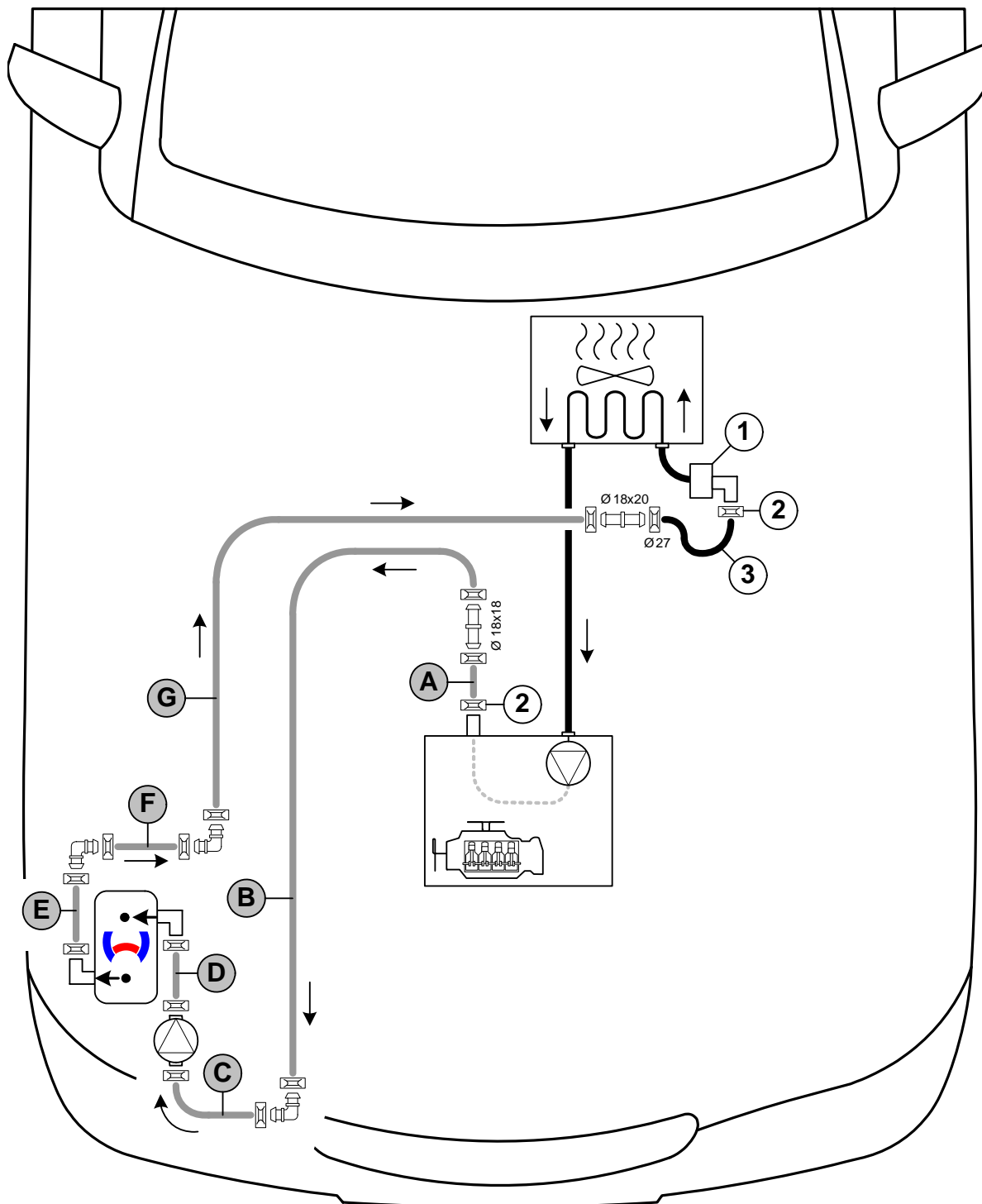



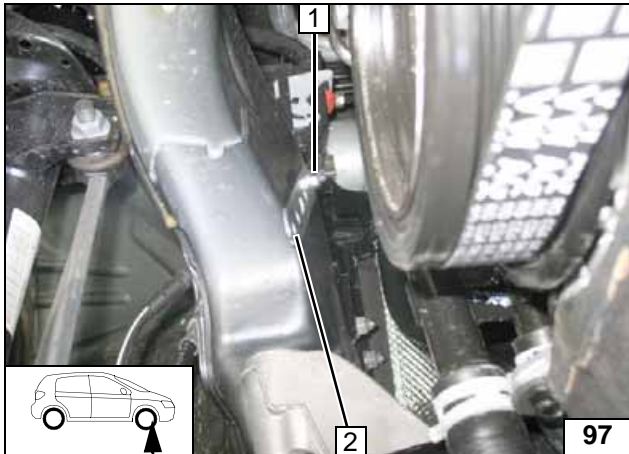

Diagram of hose routing

All spring clips without a specific designation  = 25 mm dia. **2** = Original vehicle spring clip .
1 = EGR! **3** = original vehicle hose.
 All connecting pipes  = 18x18mm dia.





- 1 M6 flanged nut, original vehicle stud bolt
- 2 Perforated bracket

Installing perforated bracket

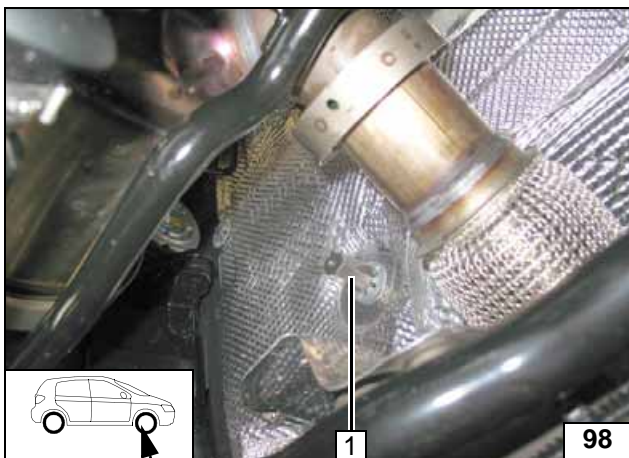

- 1 M6x30 spacer nut, original vehicle stud bolt

Installing spacer nut

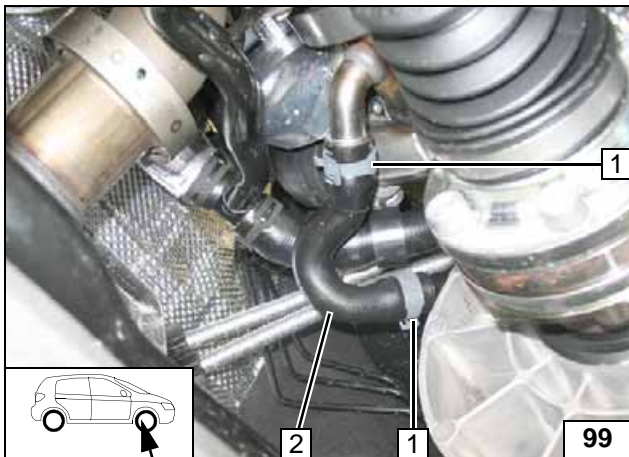

Remove hose of engine outlet / EGR inlet 2. Spring clips 1 will be reused.



Cutting point

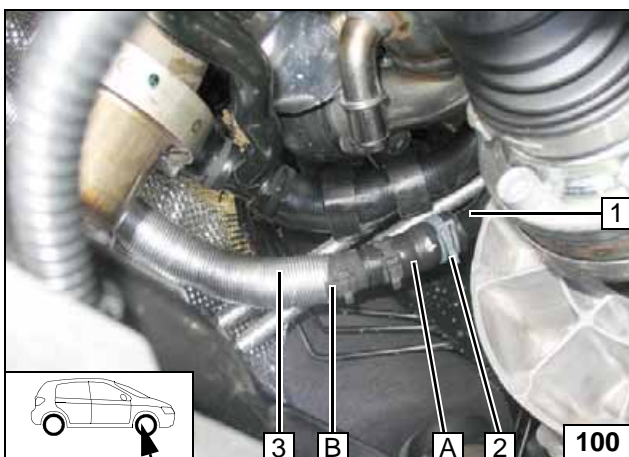

Slide 800mm long heat protection hose 3 onto hose B.

- 1 Pipe of engine outlet
- 2 Original vehicle spring clip



Connecting engine outlet

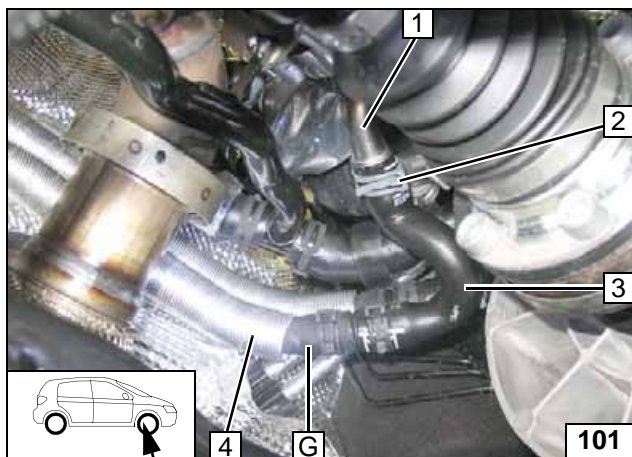

Slide 800mm long heat protection hose 4 onto hose G.

- 1 Pipe of EGR inlet
- 2 Original vehicle spring clip
- 3 Original vehicle hose mounted in the opposite direction



**Connect-
ing heat ex-
changer
inlet**

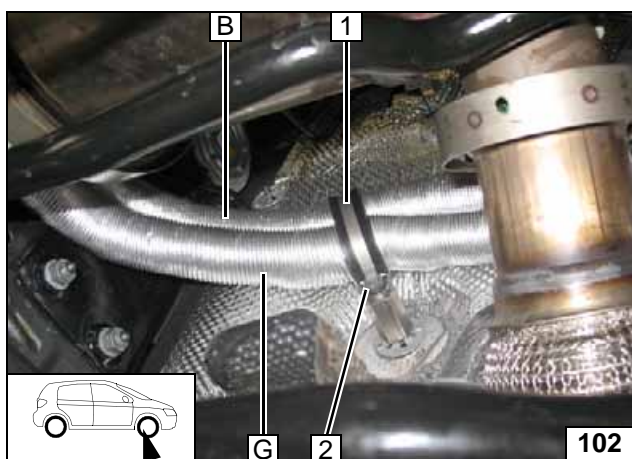

- 1 48 mm dia. rubber-coated p-clamp
- 2 M6x20 bolt, spring lockwasher

**Fastening on
firewall**



Align hoses. Ensure sufficient distance to catalytic converter at position 1, correct if necessary.



**Routing in
engine
compartment**

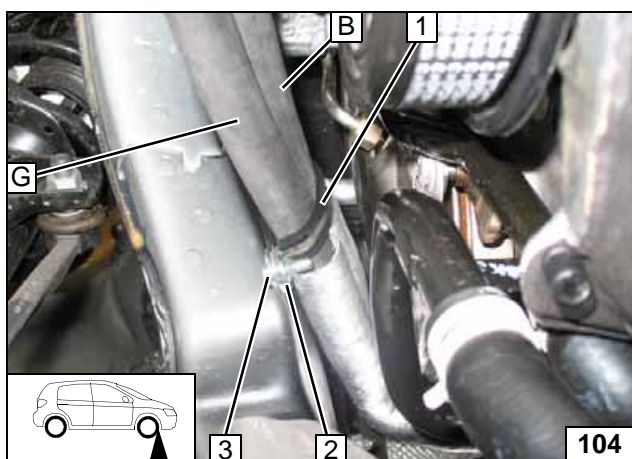

- 1 38 mm dia. rubber-coated p-clamp
- 2 Perforated bracket
- 3 M6x20 bolt, flanged nut

**Routing on
frame side
member**

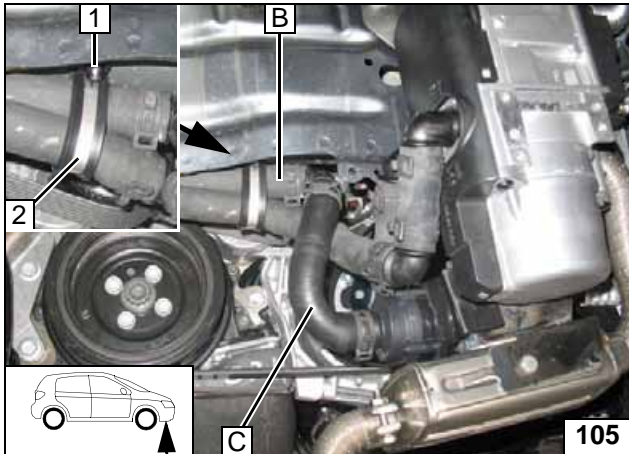

- 1 Original vehicle stud bolt, plastic nut
- 2 38 mm dia. rubber-coated p-clamp

**Connect-
ing heater
inlet**

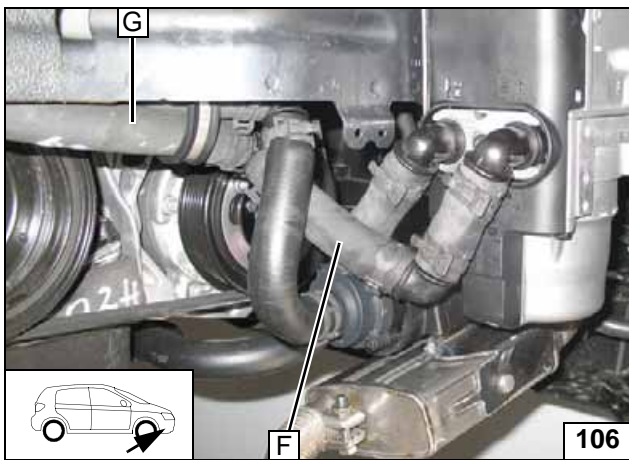

Align hoses. Ensure sufficient distance to neighbouring components, adjust, if necessary.



**Connect-
ing heater
outlet**

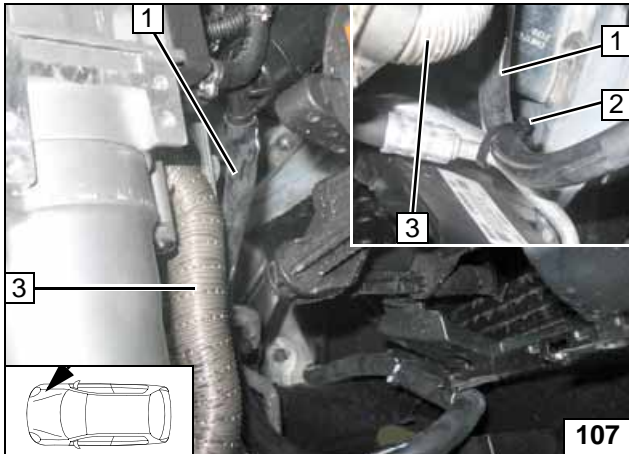

Final Work

1.4 TFSI / TDI

Fasten hose of headlight washer system 1 with cable ties 2 to A/C line. Ensure sufficient distance (at least 20mm) between exhaust pipe 3 and headlight washer system hose 1.



Aligning exhaust pipe

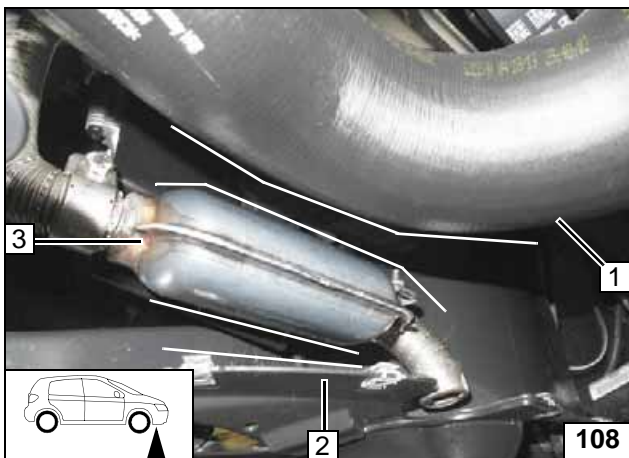

1.8 TFSI

Ensure sufficient distance of exhaust silencer 3 to wheel-well inner panel 2 and charge-air hose 1, correct if necessary.



Aligning exhaust silencer

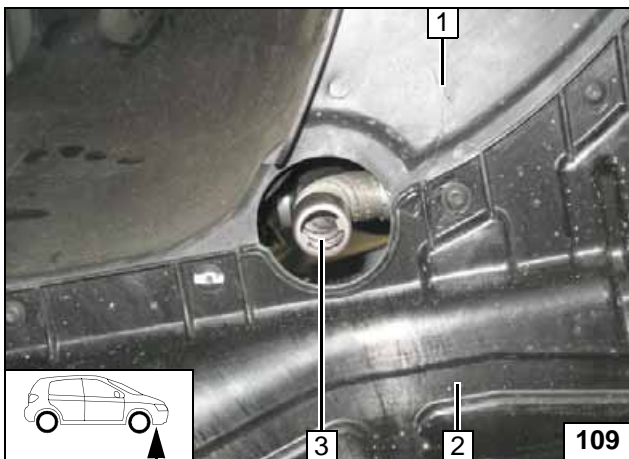

Mounting underide protection

Variant A

Align exhaust end section 3 at the centre of the pass through.

- 1 Wheel well trim mounted
- 2 Underide protection (plastic) mounted



Aligning exhaust end section

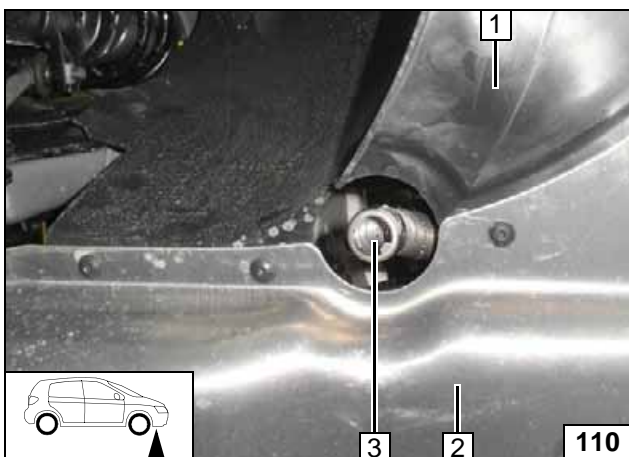

Variant B

Align exhaust end section 3 at the centre of the pass through.

- 1 Wheel well trim mounted
- 2 Underide protection (metal) mounted



Aligning exhaust end section



WARNING!

Reassemble the disassembled components in reverse order. Check all hoses, clamps and all electrical connections for firm seating. Insulate and tie back all loose lines.

Only use manufacturer-approved coolant. Spray the heater components with anti-corrosion wax (Tectyl 100K, Order No. 111329).



- **Connect the battery**
- **Fill and bleed the coolant circuit according to the vehicle manufacturer's specifications.**
- **Program MultiControl CAR, teach Telestart transmitter**
- **The J255 A/C control unit has to be programmed to "parking heater without Can".**
- **Make settings on A/C control panel according to the "Operating Instructions for End Customer".**
- **Place the "Switch off parking heater before refuelling" caution label in the area of the filler neck.**
- **For initial start-up and function check, see installation instructions.**



Operating Instructions for Climatic

Please remove page and add to the vehicle operating instructions.

Note:

We recommend matching the heating time to the driving time.
 Heating time = driving time

Example:

For a driving time of approx. 20 min. (in one direction), we recommend not exceeding a switch-on time of 20 min.

Passenger compartment monitoring, if installed, must be deactivated in addition to the vehicle settings for the heating operation .

Please refer to the Operating Manual of the vehicle for instructions concerning the deactivation.

Before parking the vehicle, make the following settings:

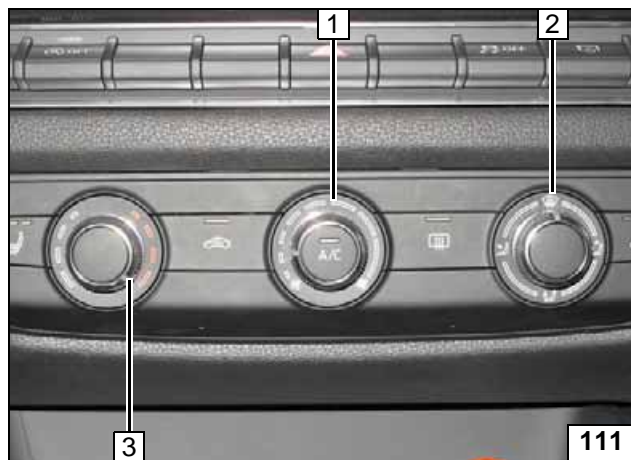

- 1 Set fan to level "1", max. "2"
- 2 Air outlet to windscreen
- 3 Set temperature to "max."



A/C control panel

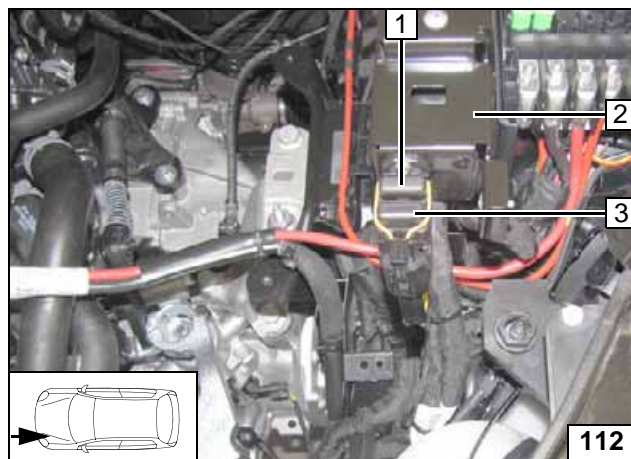

Figure shows vehicle with protective housing at position 2.

- 1 30A passenger compartment main fuse F2
- 3 20A heater fuse F1



Fuses of engine compartment

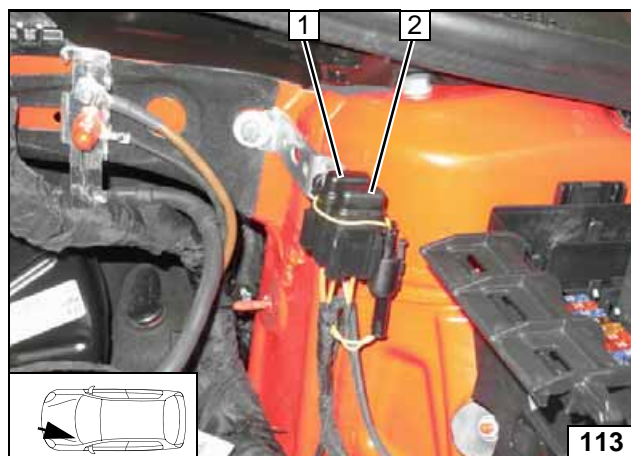

Figure shows vehicle without protective housing.

- 1 30A passenger compartment main fuse F2
- 2 20A heater fuse F1



Fuses of engine compartment



Audi A3 / A3 Convertible

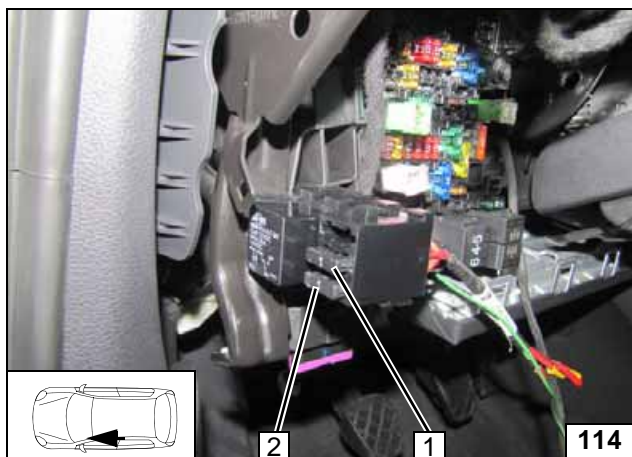

- 1 1A fuse F3 of heater control
- 2 1A fan fuse F4

**Fuses of pas-
senger com-
partment**

Operating Instructions for Climatronic

Please remove page and add to the vehicle operating instructions.

Note:

We recommend matching the heating time to the driving time.
Heating time = driving time

Example:

For a driving time of approx. 20 min. (in one direction), we recommend not exceeding a switch-on time of 20 min.

Passenger compartment monitoring, if installed, must be deactivated in addition to the vehicle settings for the heating operation .

Please refer to the Operating Manual of the vehicle for instructions concerning the deactivation.

No settings on the A/C control panel required!

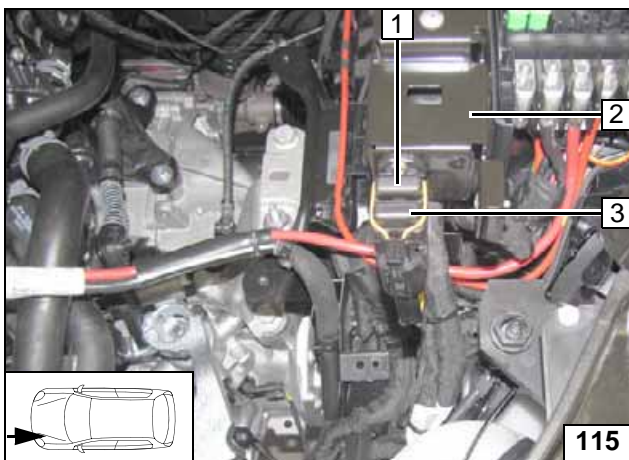

Figure shows vehicle with protective housing at position 2.

- 1 30A passenger compartment main fuse F2
- 3 20A heater fuse F1

Fuses of engine compartment

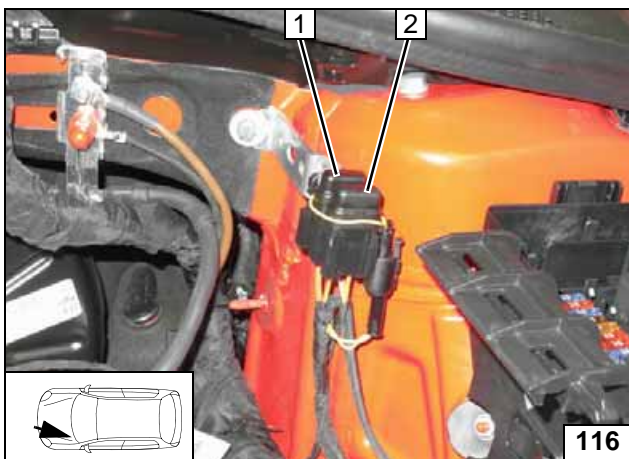
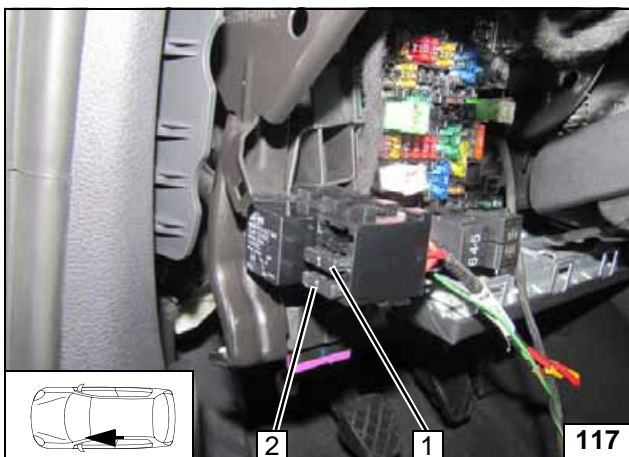

Figure shows vehicle without protective housing.

- 1 30A passenger compartment main fuse F2
- 2 20A heater fuse F1

Fuses of engine compartment



- 1 1A fuse F3 of heater control
- 2 1A fan fuse F4

Fuses of passenger compartment

