

Water Heater

Thermo Top Evo Parking Heater



Installation Documentation

Fiat 500L

Validity

| Manufacturer | Model | Type | EG-BE No./ ABE |
|--------------|-------|------|-----------------------------|
| Fiat | 500L | 312 | e3 * 2001 / 116 * 0217 *... |

| Motorisation | Fuel | Transmission type | Output in kW | Displacement in cm ³ | Engine code |
|------------------|--------|-------------------|--------------|---------------------------------|-------------|
| 1.6 JTD MultiJet | Diesel | SG | 77 | 1598 | 199B5000 |

SG = manual transmission

From Model Year 2014

Left-hand drive vehicle

Verified equipment variants: Manual / automatic air-conditioning system

Front fog lights

Start / Stop

Not verified:

Passenger compartment monitoring

Headlight washer system

Total installation time: approx. 8 hours

Fiat 500L

Table of Contents

| | | | |
|--|----|---|----|
| Validity | 1 | Preparing Installation Location | 16 |
| Necessary Components | 2 | Preparing Heater | 16 |
| Installation Overview | 2 | Installing Heater | 18 |
| Information on Total Installation Time | 2 | Coolant Circuit | 20 |
| Information on Operating and Installation Instructions | 3 | Combustion Air | 25 |
| Information on Validity | 4 | Exhaust Gas | 26 |
| Technical Information | 4 | Fuel | 28 |
| Explanatory Notes on Document | 4 | Final Work | 32 |
| Preliminary Work | 5 | Final Work | 32 |
| Heater Installation Location | 5 | Template for Fuel Standpipe | 34 |
| Preparing Electrical System | 6 | Template for Bracket | 35 |
| Electrical System | 9 | Operating Instructions for Manual Air-Conditioning | 36 |
| Fan Controller for Manual Air-Conditioning | 10 | Operating Instructions for Automatic Air-Conditioning | 37 |
| Fan Controller for Automatic Air-Conditioning | 12 | | |
| MultiControl CAR Option | 15 | | |
| Remote Option (Telestart) | 15 | | |

Necessary Components

- Basic delivery scope of *Thermo Top Evo* based on price list
- Installation kit for Fiat 500L 2014 1.6 JTD: **1323675A**
- To be ordered additionally in case of automatic air-conditioning, automatic air-conditioning kit: **1320864B**
- Heater control in accordance with price list and upon consultation with end customer
- In case of Telestart, indicator lamp in accordance with price list and in consultation with end customer

Installation instructions:

- Arrange for the vehicle to be delivered with the tank only about ¼ full.
- The installation location of the push button for Telestart or Thermo Call must be agreed with the end customer.
- Depending on the available space and manufacturer's instructions, we recommend the use of a vehicle battery with more electrical capacity.

Installation Overview

Legend:

1. Heater
2. Engine compartment fuse holder
3. Passenger compartment relay and fuse holder
4. PWM GW (only in case of automatic air-conditioning)
5. Circulating pump
6. MultiControl CAR
7. Metering pump

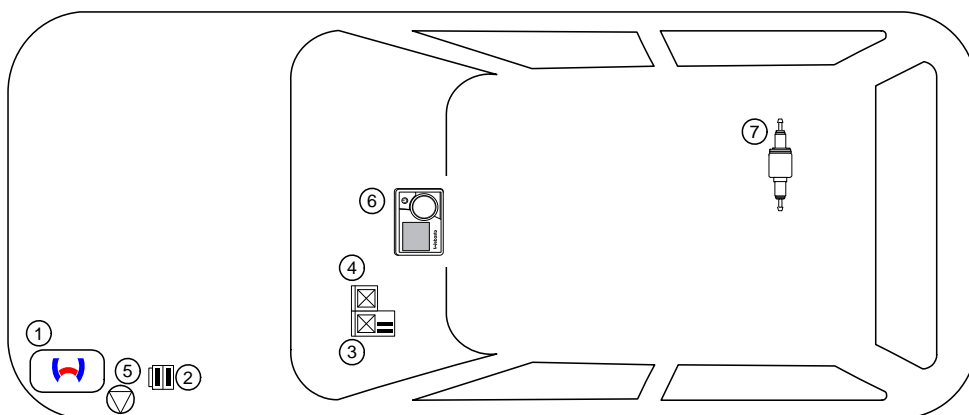

Information on Total Installation Time

The total installation time includes the time needed for mounting and demounting of the vehicle-specific components, the heater specific installation time and all other times required for the system integration and initial start-up of the heater.

The total installation time may vary for vehicle equipment other than provided.

Information on Operating and Installation Instructions

1 Important notes (not complete)

1.1 Installation and Repair



The improper installation or repairing of Webasto heating and cooling systems can cause fire or the leakage of deadly carbon monoxide, leading to serious injury or death.



To install and repair Webasto heating and cooling systems you need to have completed a special company training course and have the appropriate technical documentation, special tools and special equipment.



Installation and repair may ONLY be carried out by persons trained and certified in a Webasto training course. NEVER try to install or repair Webasto heating or cooling systems if you have not completed a Webasto training course, you do not have the necessary technical skills and you do not have the technical documentation, tools and equipment available to ensure that you can complete the installation and repair work properly.

Only use genuine Webasto parts. See the Webasto air and water heaters accessories catalogue for this purpose.

1.2 Operation

To ensure safe operation, we recommend having the heater checked every two years by an authorised Webasto dealer, especially when used over a long period and/or under extreme environmental conditions.

Do not operate the heater in closed rooms due to the danger of poisoning and suffocation.

Always switch off the heater before refuelling.

The heater may only be used with the prescribed fuel diesel (DIN EN 590) or petrol (DIN EN 228).

The heater may not be cleaned with a high-pressure cleaner.

1.3 Please note

ALWAYS follow all Webasto installation and operating instructions and observe all warnings.

To become familiar with and understand all functions and properties of the heater, the operating instructions must be read carefully and observed at all times.

For proper, safe installation and repair work, the installation instructions with all warnings and safety information must be carefully read and observed at all times. Please always contact a workshop authorised by Webasto for all installation and repair work.

Important

Webasto shall assume no liability for defects, damage and injuries resulting from a failure to observe the installation, repair and operating instructions of the information contained in them.

This liability exclusion particularly applies to improper installations and repairs, installations and repairs by untrained persons or in the case of a failure to use genuine spare parts.

The liability due to culpable disregard to life, limb or health and due to damage or injuries caused by a wilful or reckless breach of duty remain unaffected, as does the obligatory product liability.

Installation should be carried out according to the general, standard rules of technology. Unless specified otherwise, fasten hoses, lines and wiring harnesses to original vehicle lines and wiring harnesses using cable ties. Insulate loose wire ends and tie back. Connectors on electronic components must audibly snap into place during assembly.

Sharp edges should be fitted with rub protection. Spray unfinished body areas, e.g. drilled holes, with anti-corrosion wax (Tectyl 100K, Order No. 111329).

Observe the instructions and guidelines of the respective vehicle manufacturer for demounting and mounting vehicle specific components!

The initial startup is to be executed with the Webasto Thermo Test Diagnosis.

When installing a programmable control module (e.g. a PWM Gateway), the corresponding settings must be checked or adjusted.

2 Statutory regulations governing installation

| Guidelines | TT-Evo |
|----------------------------|------------|
| Heating Directive ECE R122 | E1 00 0258 |
| EMC Directive ECE R10 | E1 04 5627 |

Note

The regulations of these guidelines are binding in the scope of the Directive 70/156/EEC and/or 2007/46/EC (for new vehicle models from 29/04/2009) and should also be observed in countries in which there are no special regulations.

Important

Failure to follow the installation instructions will result in the invalidation of the type approval for the heater and therefore invalidation of the general **homologation of the vehicle**.

Note

The heater is licensed in accordance with paragraph 19, section 3, No. 2b of the StVZO (German Road Traffic Licensing Authority).

2.1 Excerpt from the directive 122 (heater) section 5 for the installation of the heater.

Beginning of excerpt.

ANNEX VII

REQUIREMENTS FOR COMBUSTION HEATERS AND THEIR INSTALLATION

1. GENERAL REQUIREMENTS

1.7.1. A clearly visible tell-tale in the operator's field of view shall inform when the combustion heater is switched on or off.

2. VEHICLE INSTALLATION REQUIREMENTS

2.1. Scope

2.1.1. Subject to paragraph 2.1.2. combustion heaters shall be installed according to the requirements of this Annex.

2.1.2. Vehicles of category O having liquid fuel heaters are deemed to comply with the requirements of this Annex.

2.2. Positioning of heater

2.2.1. Body sections and any other components in the vicinity of the heater must be protected from excessive heat and the possibility of fuel or oil contamination.

2.2.2. The combustion heater shall not constitute a risk of fire, even in the case of overheating. This requirement shall be deemed to be fulfilled if the installation ensures an adequate distance to all parts and suitable ventilation, by the use of fire resistant materials or by the use of heat shields.

2.2.3. In the case of M2 and M3 vehicles, the heater must not be positioned in the passenger compartment. However, an installation in an effectively sealed envelope which also complies with the conditions in paragraph 2.2.2 may be used.

2.2.4. The label referred to in paragraph 1.4 or a duplicate, must be positioned so that it can be easily read when the heater is installed in the vehicle.

2.2.5. Every reasonable precaution should be taken in positioning the heater to minimise the risk of injury and damage to personal property.

2.3. Fuel supply

2.3.1. The fuel filler must not be situated in the passenger compartment and must be provided with an effective cap to prevent fuel spillage

2.3.2. In the case of liquid fuel heaters, where a supply separate to that of the vehicle is provided, the type of fuel and its filler point must be clearly labelled

2.3.3. A notice, indicating that the heater must be shut down before refuelling, must be affixed to the fuelling point. In addition a suitable instruction must be included in the manufacturer's operating manual.

2.4. Exhaust system

2.4.1. The exhaust gas outlet must be located so as to prevent emissions from entering the vehicle through ventilators, heated air inlets or opening windows.

2.5. Combustion air inlet

2.5.1. The air for the combustion chamber of the heater must not be drawn from the passenger compartment of the vehicle.

2.5.2. The air inlet must be so positioned or guarded that blocking by rubbish or luggage is unlikely.

2.6. Heating air inlet

2.6.1. The heating air supply may be fresh or recirculated air and must be drawn from a clean area not likely to be contaminated by exhaust fumes emitted either by the propulsion engine, the combustion heater or any other vehicle source.

2.6.2. The inlet duct must be protected by mesh or other suitable means.

2.7. Heating air outlet

2.7.1. Any ducting used to route the hot air through the vehicle must be so positioned or protected that no injury or damage could be caused if it were to be touched.

2.7.2. The air outlet must be so positioned or guarded that blocking by rubbish or luggage is unlikely.

End of excerpt.

In multilingual versions the German language is binding.

Fiat 500L

Information on Validity

This installation documentation applies to Fiat 500L 1.6 JTD MultiJet vehicles - for validity, see page 1 - from model year 2014 and later, assuming technical modifications to the vehicle do not affect installation, any liability claims excluded. Depending on the vehicle version and equipment, modifications may be necessary during installation with respect to this installation documentation.

Vehicle and engine types, equipment variants and other specifications not listed in this installation documentation have not been tested. However, installation according to this installation documentation may be possible.

Technical Information

Special tools

- Hose clamp pliers for self-clamping hose clamps
- Hose clamp pliers for Clic hose clamps of type W
- Wire stripper 0.2 - 6mm²
- Crimping pliers for cable lug / tab connector 0.5 - 6mm²
- Torque wrench for 2.0 - 10 Nm
- Hose clamping pliers
- Metric thread-setter kit
- Webasto Thermo Test Diagnosis with current software

Dimensions

- All dimensions are in mm

Tightening torque values

- Tightening torque values of 5x13 heater bolts and 5x11 heater stud bolts = 8 Nm.
- Tightening torque values of 5x15 bolts for retaining plate of water connection piece = 7Nm.
- Tighten other bolt connections in accordance with manufacturer's instructions or in accordance with state-of-the-art-technology.

Explanatory Notes on Document

You will find an identification mark on the outside top right corner of the page in question to provide you with a quick overview of the individual working steps.

Special features are highlighted using the following symbols:

Mechanical system



Specific risk of injury or fatal accidents.



Electrical system



Specific risk due to electrical voltage.



Coolant circuit



Specific risk of damage to components.



Combustion air



Specific risk of fire or explosion.



Fuel



Reference to general installation instructions of the Webasto components or to the manufacturer's vehicle-specific documents



Reference to a special technical feature.



Exhaust gas



The arrow in the vehicle icon indicates the position on the vehicle and the viewing angle

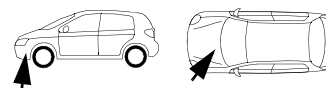

Software



Tightening torque according to the manufacturer's vehicle-specific documents



Fiat 500L

Preliminary Work

Vehicle

- Open the fuel tank cap.
- Ventilate the fuel tank.
- Close the fuel tank cap again.
- Depressurise the cooling system.
- Remove the upper engine cover.
- Disconnect the battery and remove completely, including the carrier.
- Remove the windscreen wiper arms on the left and right.
- Remove the cowl panel.
- Remove the wiper motor with linkage.
- Fold back the backrest of the rear bench seat, completely fold back the bench seat.
- Remove the trim below the bench seat (4x plastic clip).
- Remove the lower engine cover / underride protection.
- Remove the trim of the fuel lines on the underbody.
- Remove the wheel well trim on the left side, detach it on the right side.
- Remove the bumper trim.
- Remove the left engine cover.
- Remove the washer reservoir.
- Remove the footwell trim below the glove compartment.
- Remove the lateral cover of the centre console.
- Remove the cover of the fan controller in the footwell on the front passenger's side (only in case of automatic air-conditioning).
- Remove the cover/access to the driver's side fuse box.
- Remove the lower cover of the instrument panel trim on the left (bolted 2x).

The following work should only be performed during the corresponding installation sequence:

- Open the tank-fitting service lid.
- Remove the fuel-tank sending unit in accordance with the manufacturer's instructions.

Heater

- Remove years that do not apply from the type and duplicate label.
- Attach the duplicate label (type label) in the appropriate place in the engine compartment.

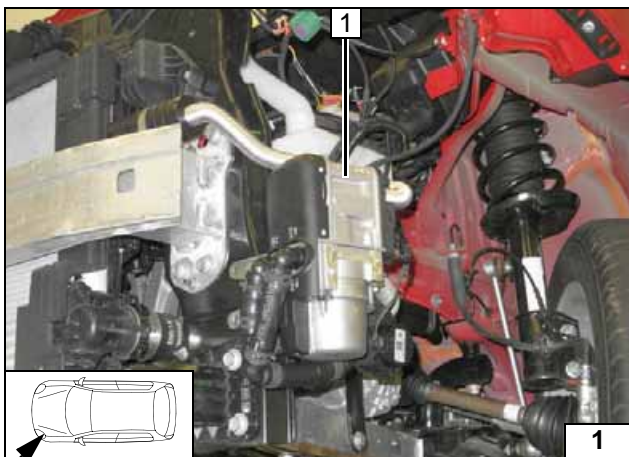

Heater Installation Location

- 1 Heater

Installation location

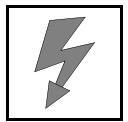

Preparing Electrical System

Wire sections retain their numbering throughout the whole document.

Produce all following electrical connections as shown in the wiring diagram.

Manual air-conditioning

- ① Red (rt) wire of fan wiring harness
- ② Black (sw) wire of fan wiring harness



Assigning wires



Connecting wires to socket of passenger compartment relay and fuse holder



Cutting to length / assigning wires

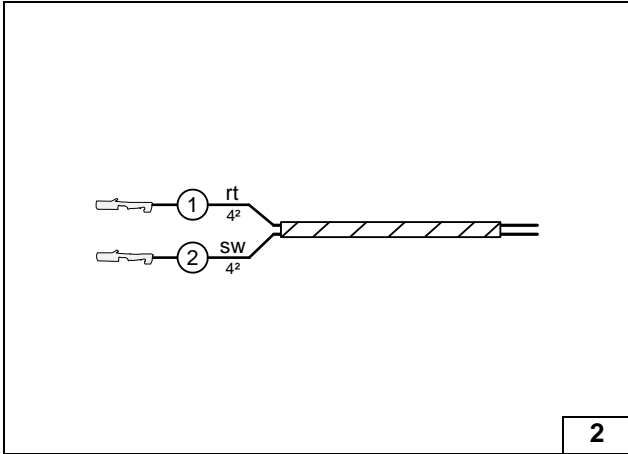

2

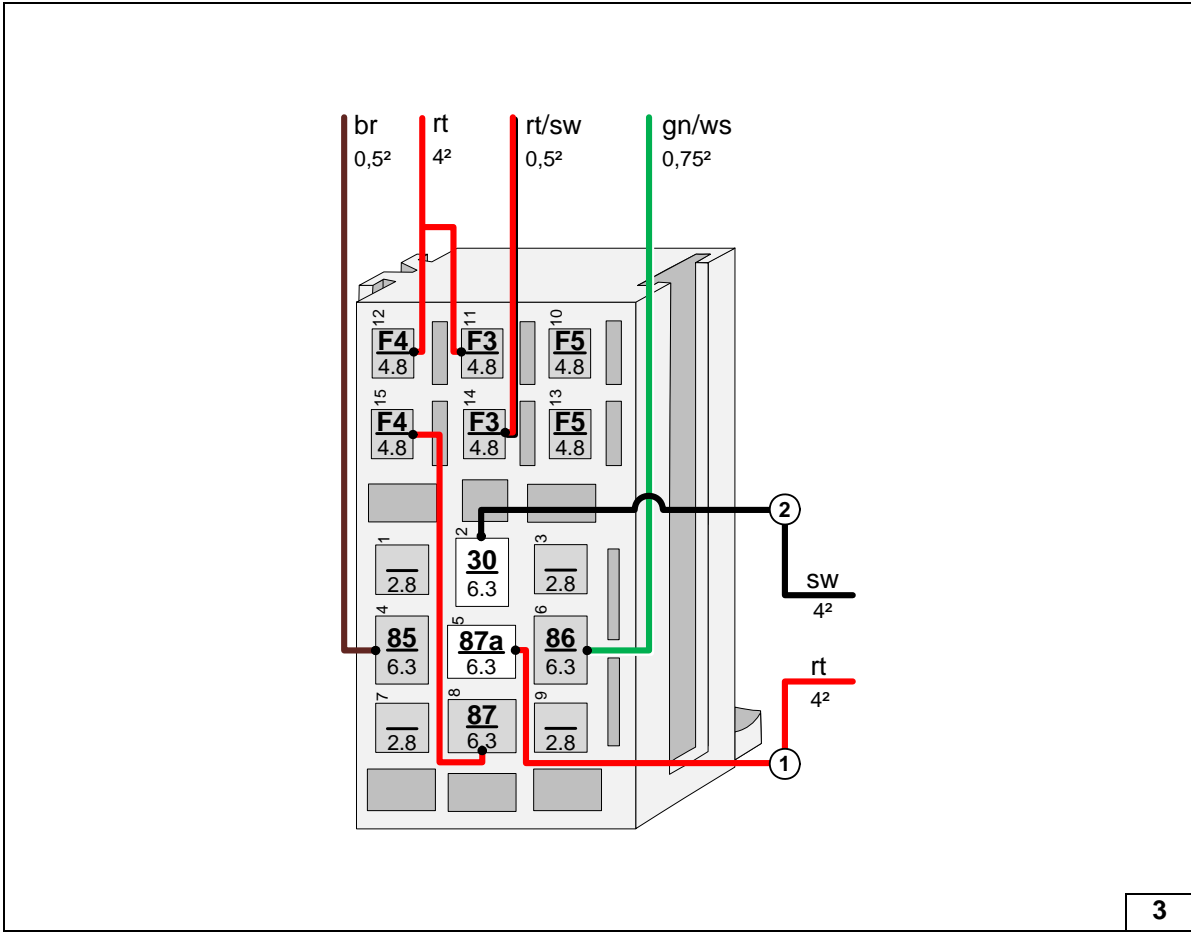

3

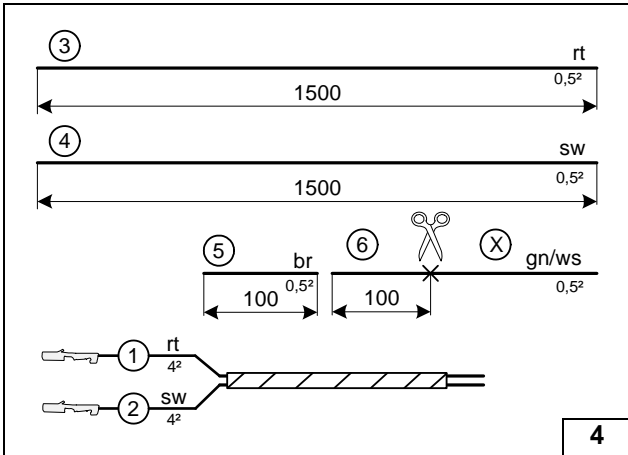

4

Automatic air-conditioning

Discard section X.
Pull wires ③ and ④ into a protective sleeving.

- ① Red (rt) wire of fan wiring harness
- ② Black (sw) wire of fan wiring harness

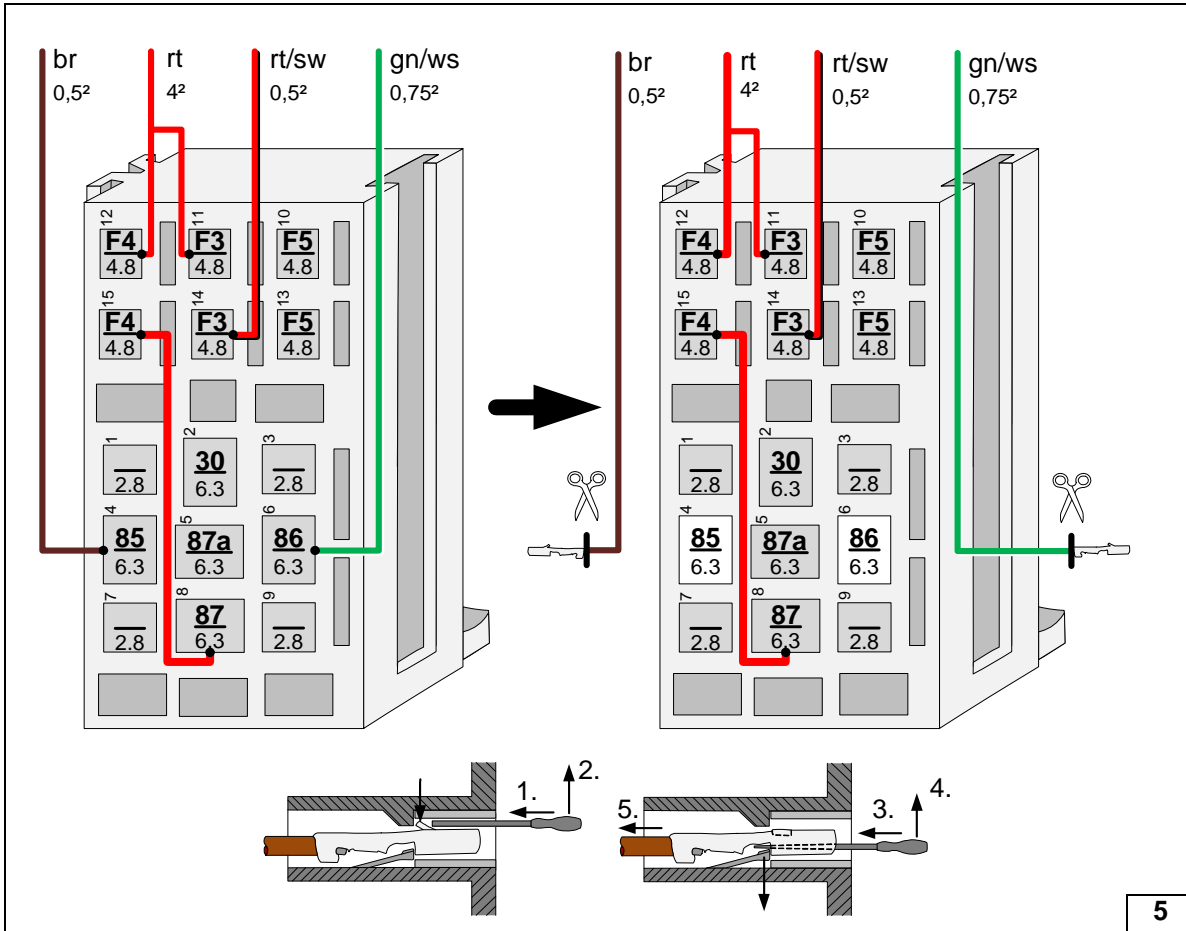
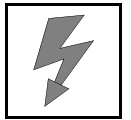

Preparing relay and fuse holder of passenger compartment

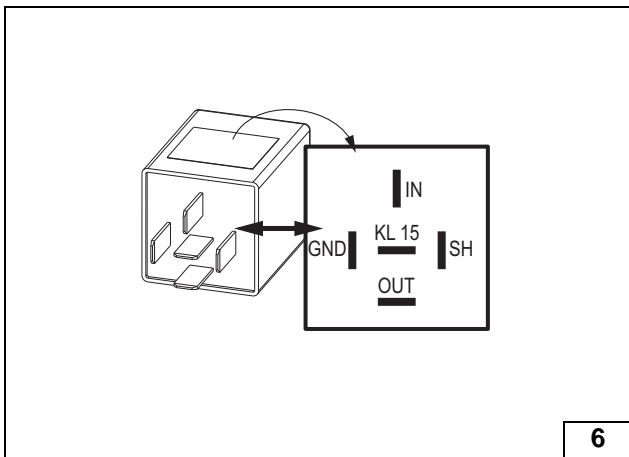

The settings of the PWM Gateway are to be checked before the heater start-up, and adjusted if necessary.



Settings:

- Duty cycle: 25%
- Frequency: 1000Hz
- Voltage: 4.8V
- Function: High side

View of PWM-GW

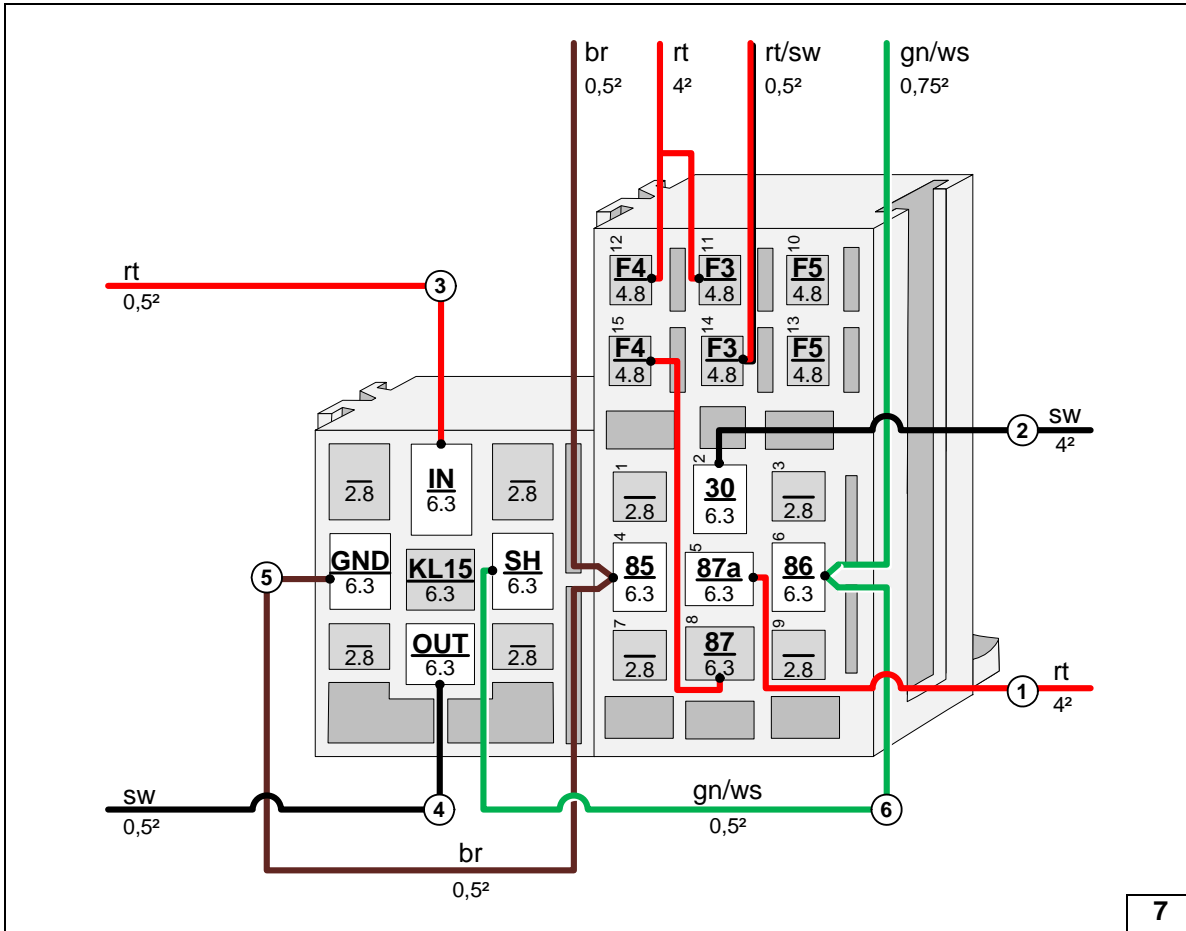
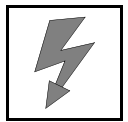

Connecting wires to sockets of PWM GW and passenger compartment relay holder and fuse holder, interconnecting sockets

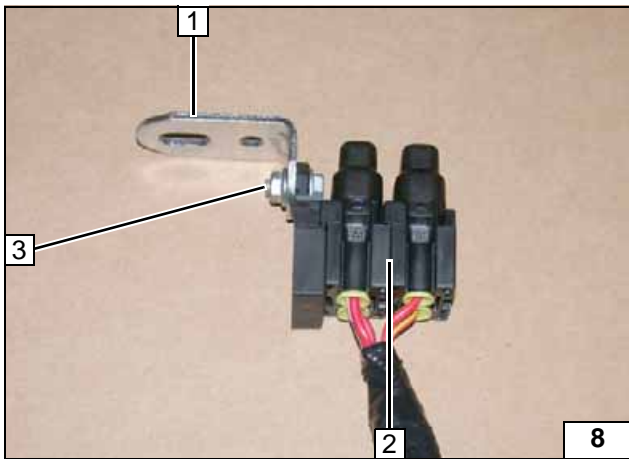

All vehicles

- 1 Angle bracket
- 2 Fuse F1-2
- 3 M5x16 bolt, large diameter washer [2x], nut

Preparing engine compartment fuse holder

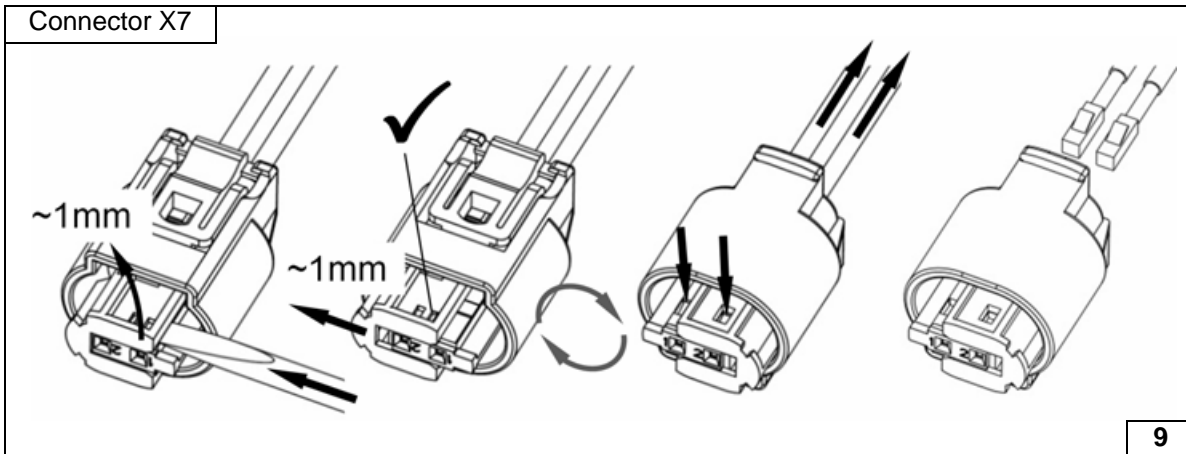

Removing metering pump connector



Electrical System

Wiring harness pass through of the engine compartment

- 1 17mm dia. hole, insert protective rubber plug
- 2 Wiring harness of heater, heater control

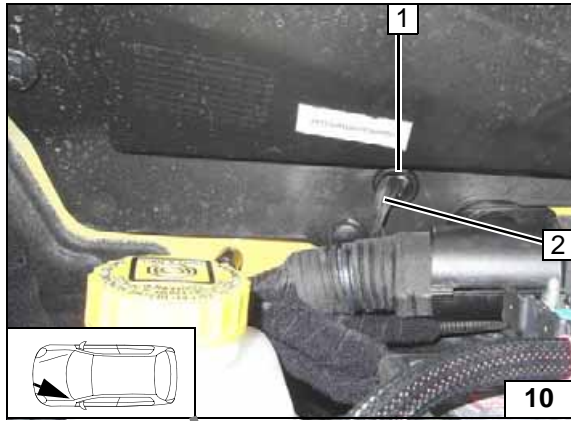

Wiring harness pass through of coolant reservoir

- 1 Protective rubber plug inserted (see image on left)
- 2 Wiring harness of heater, heater control
- 3 Original vehicle protective rubber plug
- 4 Cable tie [2x]

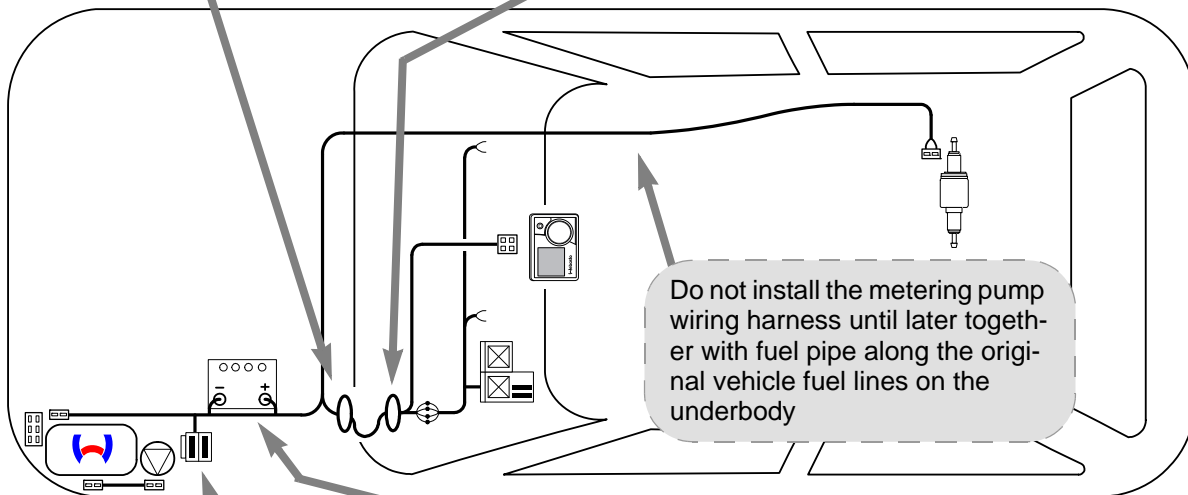
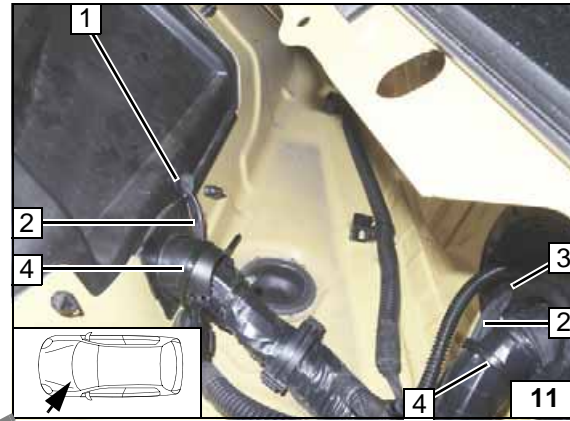

Wiring harness routing diagram

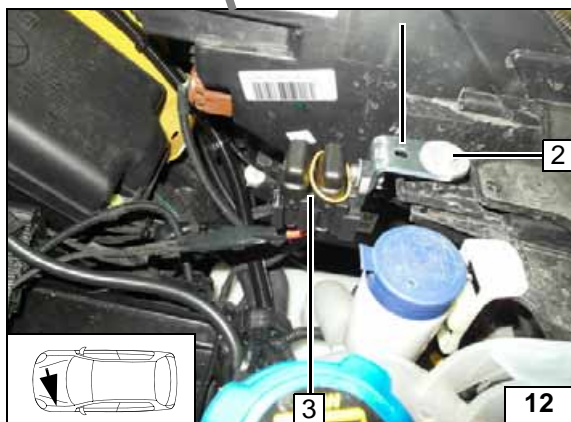

Engine compartment fuse holder

- 1 Angle bracket
- 2 Original vehicle bolt
- 3 Fuse F1-2

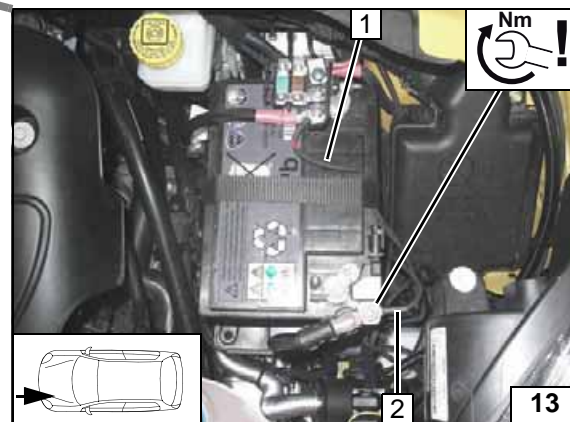

Positive and earth wire

- 1 Positive wire on positive battery terminal
- 2 Earth wire on negative battery terminal





Fan Controller for Manual Air-Conditioning

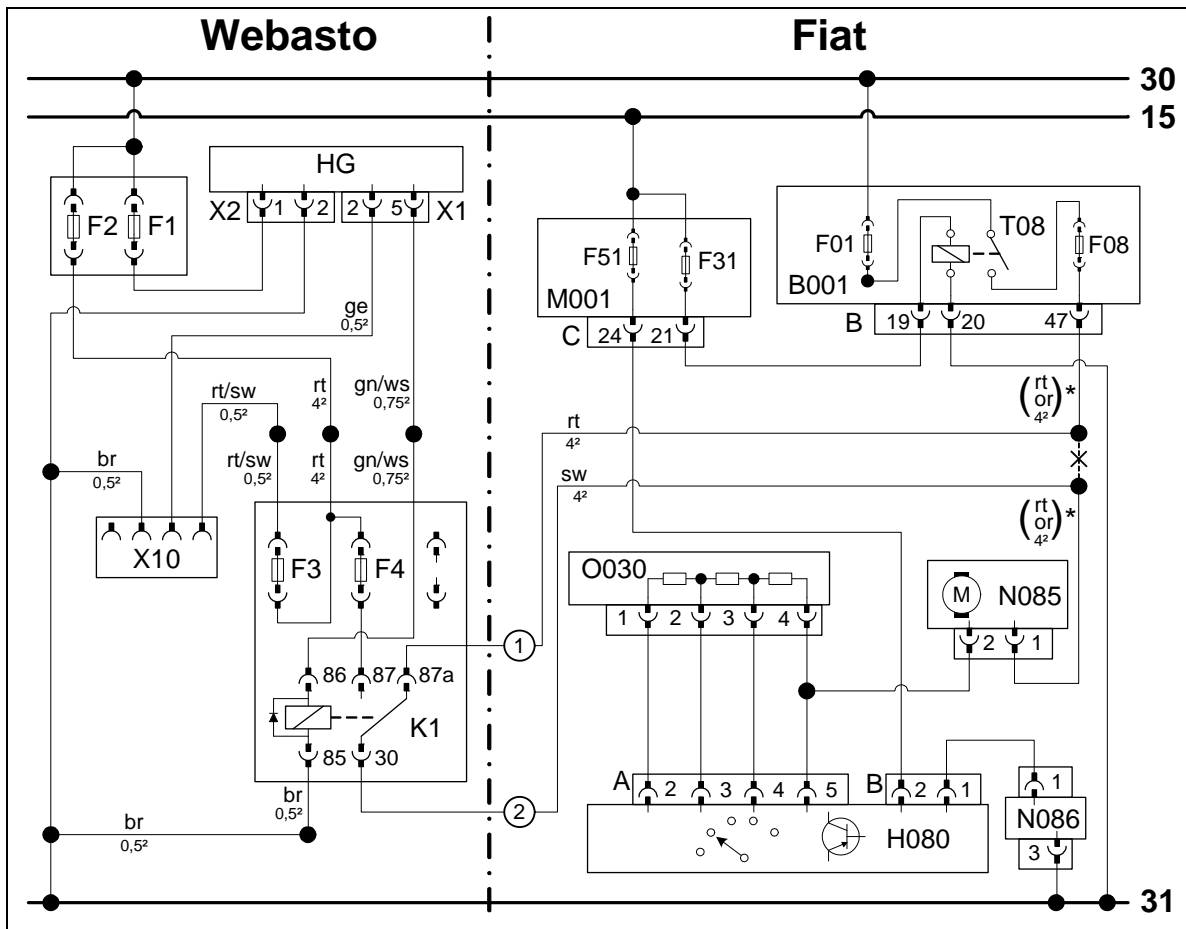

Wiring diagram

| Webasto components | | Vehicle components | | Colours and symbols | |
|--------------------|-----------------------------------|--------------------|--|---------------------|--------------------------|
| HG | TT-Evo Heater | B001 | Central electrical box in engine compartment | rt | red |
| X1 | 6-pin heater connector | | | sw | black |
| X2 | 2-pin heater connector | T08 | Fan relay | ge | yellow |
| F1 | 20A fuse | F01 | 70A fuse | gn | green |
| F2 | 30A fuse | F08 | 40A fuse | br | brown |
| X10 | 4-pin connector of heater control | B | Connector B001 | ws | white |
| F3 | 1A fuse | M001 | Body computer | or | orange |
| F4 | 25A fuse | F51 | 5A fuse | | |
| K1 | Fan relay | F31 | 5A fuse | | |
| | | C | Connector M001 | | |
| | | O030 | Resistor group | | |
| | | N085 | Fan motor | | |
| | | N086 | Electr. thermostat | | |
| | | H080 | Switch of A/C control panel | X | Cutting point |
| | | A | Connector H080 | * | Wiring colours may vary. |
| | | B | Connector H080 | | |

Legend

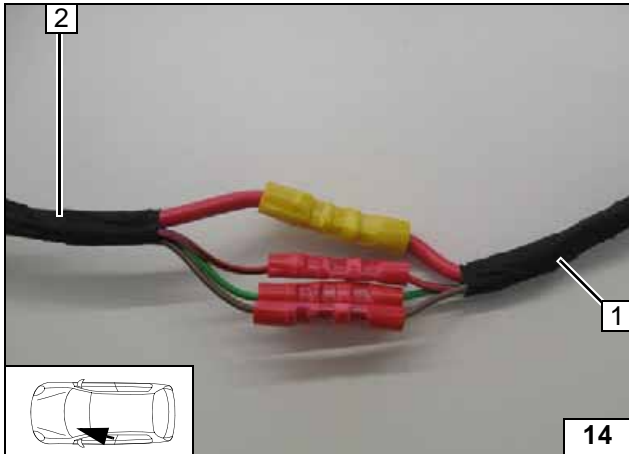
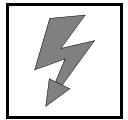

- 1 Wiring harness of passenger compartment relay and fuse holder
- 2 Wiring harness of heater

Connecting same colour wires of wiring harnesses

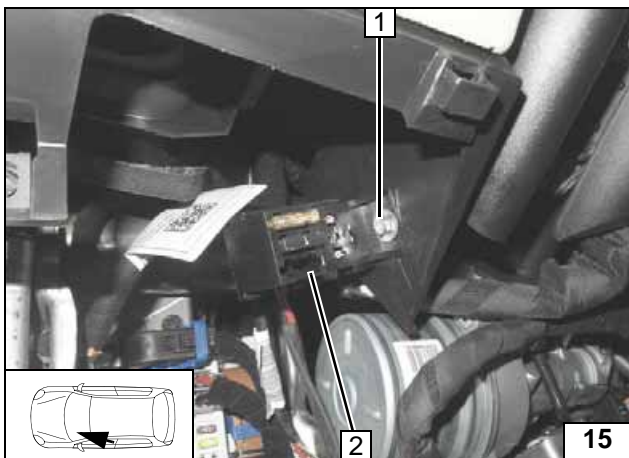

- 1 5.5 mm dia. hole, M5x16 bolt, large diameter washer [2x], nut
- 2 Passenger compartment relay and fuse holder

Installing relay and fuse holder of passenger compartment

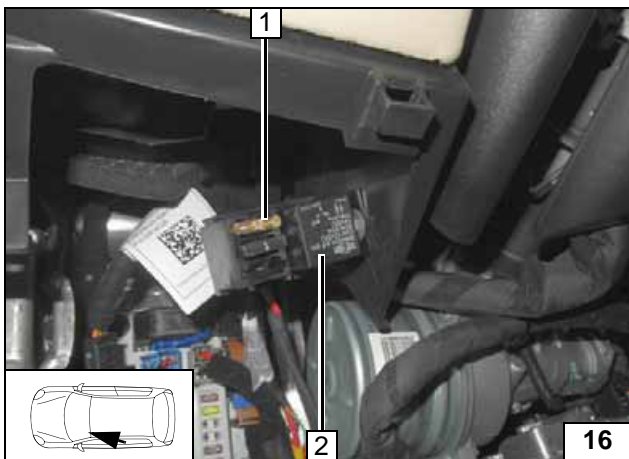

- 1 25A fuse F4
- 2 K1 relay

Installing K1 relay and F4 fuse

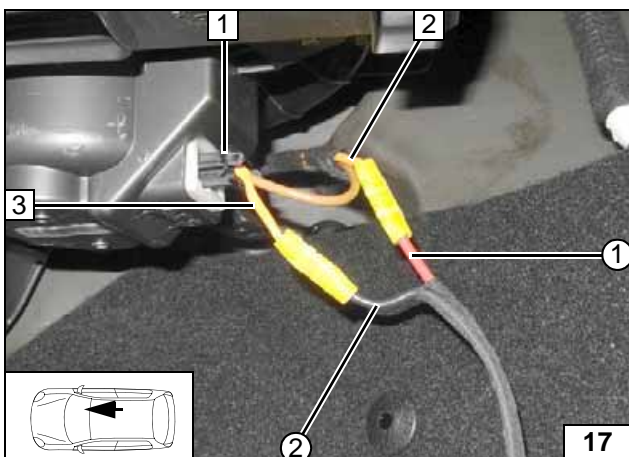

- 1 2-pin connector of fan motor N085
- 2 Red (rt) or orange (or) wire of fuse F08
- 3 Red (rt) or orange (or) wire of 2-pin connector N085/1
- ① Red (rt) wire from K1/87a, fan wiring harness
- ② Black (sw) wire from K1/30, fan wiring harness

Connection of fan motor

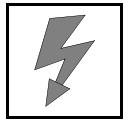

Fan Controller for Automatic Air-Conditioning



Wiring diagram

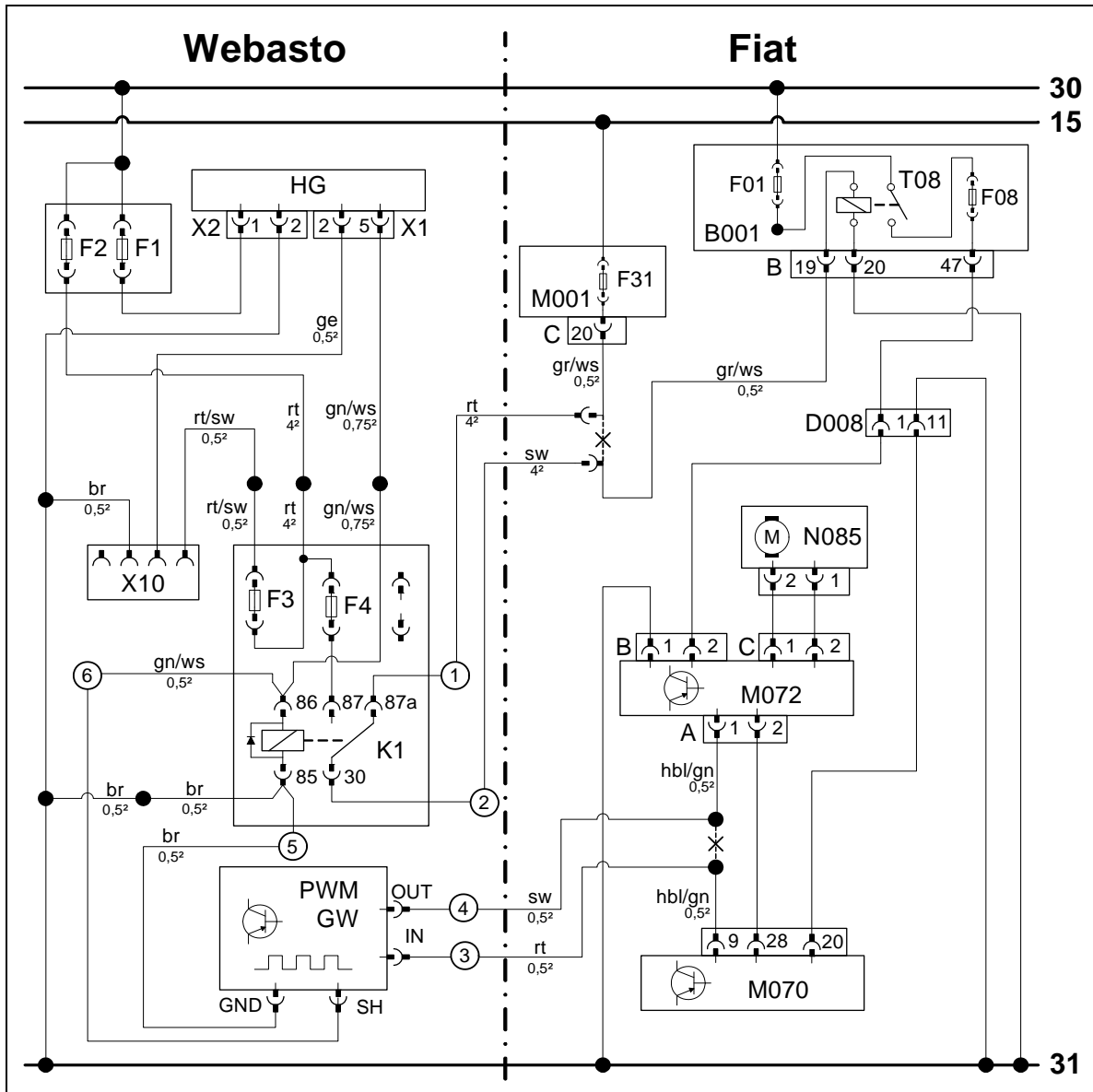

| Webasto components | | Vehicle components | | Colours and symbols | |
|----------------------------|-----------------------------------|--------------------|--|--------------------------|---------------|
| HG | TT-Evo Heater | B001 | Central electrical box in engine compartment | rt | red |
| X1 | 6-pin heater connector | | | sw | black |
| X2 | 2-pin heater connector | T08 | Fan relay | ge | yellow |
| F1 | 20A fuse | F01 | 70A fuse | gn | green |
| F2 | 30A fuse | B | Connector B001 | br | brown |
| X10 | 4-pin connector of heater control | F08 | 40A fuse | gr | grey |
| F3 | 1A fuse | M001 | Body computer | ws | white |
| F4 | 5A fuse | F31 | 5A fuse | | |
| K1 | Fan relay | C | Connector M001 | | |
| PWM GW | Pulse width modulator | D008 | Plug connection | | |
| Settings of PWM GW: | | N085 | Fan motor | | |
| Duty cycle: 25% | | M072 | Fan controller | | |
| Frequency: 1000Hz | | A | M072 connector | | |
| Voltage: 4.8V | | B | M072 connector | | |
| Function: High side | | C | M072 connector | | |
| | | M070 | A/C control unit | X | Cutting point |
| | | | | Wiring colours may vary. | |

Legend

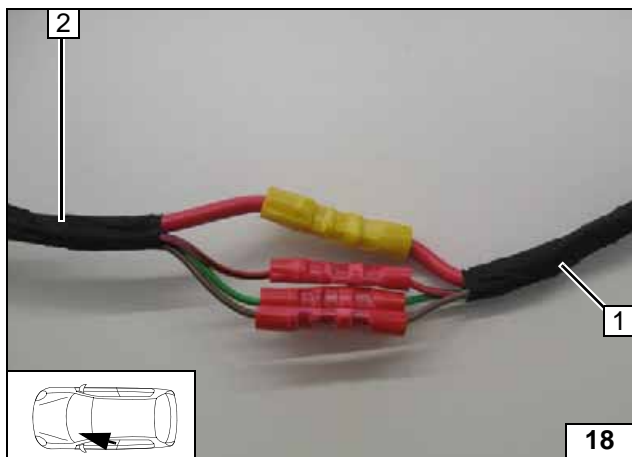
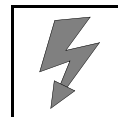

- 1 Wiring harness of passenger compartment relay and fuse holder
- 2 Wiring harness of heater

Connecting same colour wires of wiring harnesses

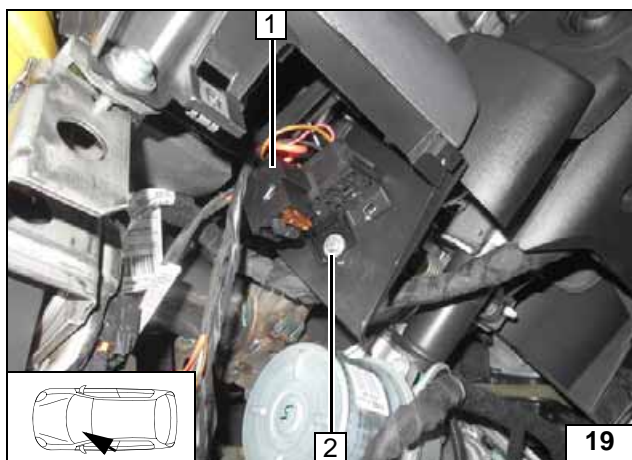

- 1 Passenger compartment relay and fuse holder
- 2 5.5 mm dia. hole, M5x16 bolt, large diameter washer [2x], nut

Installing relay and fuse holder of passenger compartment

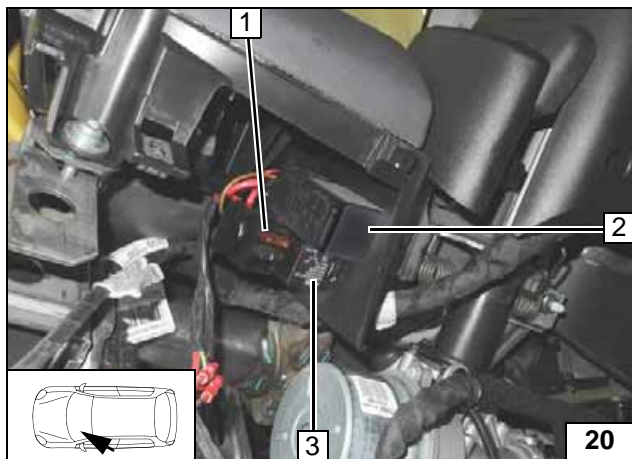

- 1 5A fuse F4
- 2 PWM GW
- 3 K1 relay

Installing K1 relay, PWM GW and fuse F4

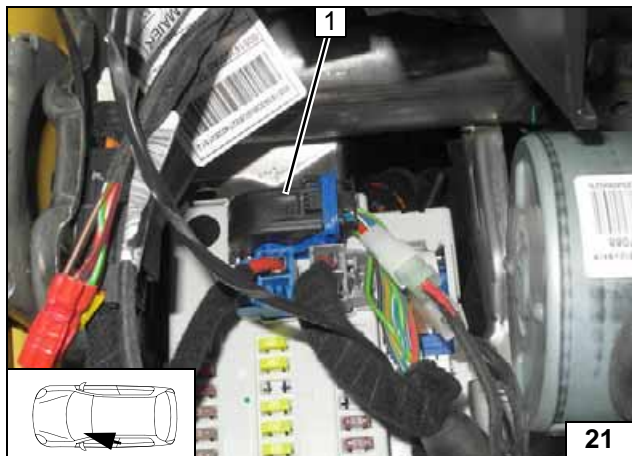

Detach 20-pin connector C 1 from Body Computer (M001) and dismantle.



Connection of Body Computer

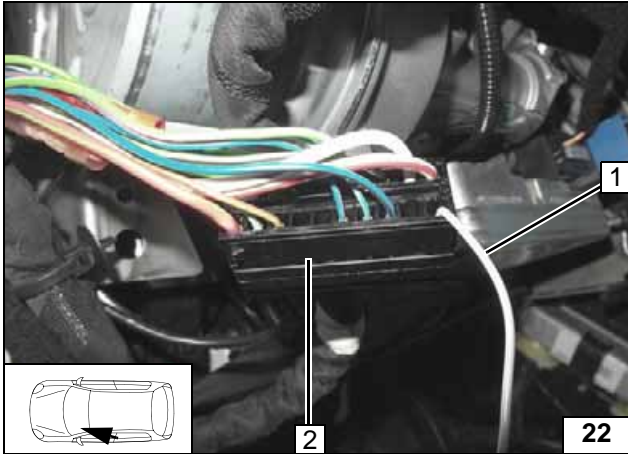
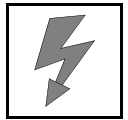

Separate grey/white (gr/ws) wire 1 100mm behind the plug connection. Reassemble the connector housing.

- 1 Grey/white (gr/ws) wire of connector C, pin 20
- 2 20-pin connector C (M001)

**Con-
nection of
Body Com-
puter**

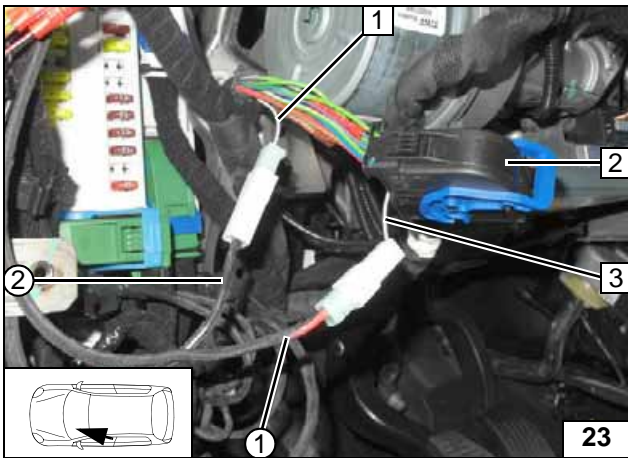

- 1 Grey/white (gr/ws) wire of connector B (B001), pin 19
- 2 20-pin connector C (M001)
- 3 Grey/white (gr/ws) wire of connector C (M001), pin 20
- ① Red (rt) wire from K1/87a, fan wiring harness
- ② Black (sw) wire from K1/30, fan wiring harness

**Con-
nection of
Body Com-
puter**

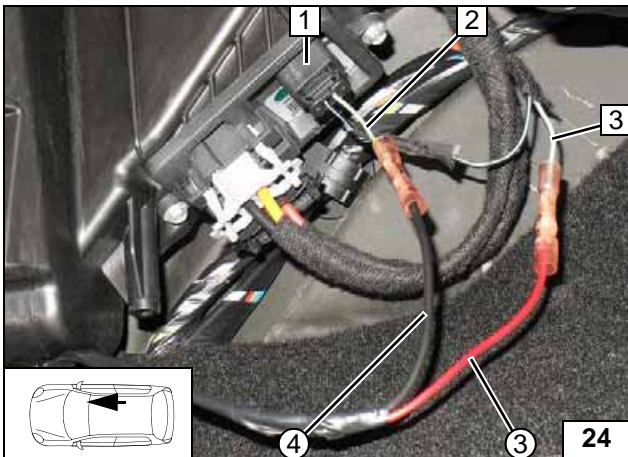

- 1 2-pin connector A (M072)
- 2 Light blue/green (hbl/gn) wire of connector A (M072), pin 1
- 3 Light blue/green (hbl/gn) wire of connector (M070), pin 9
- ③ Red (rt) wire of PWM GW/IN
- ④ Black (sw) wire of PWM GW/OUT

**Con-
nect-
ing fan con-
troller**

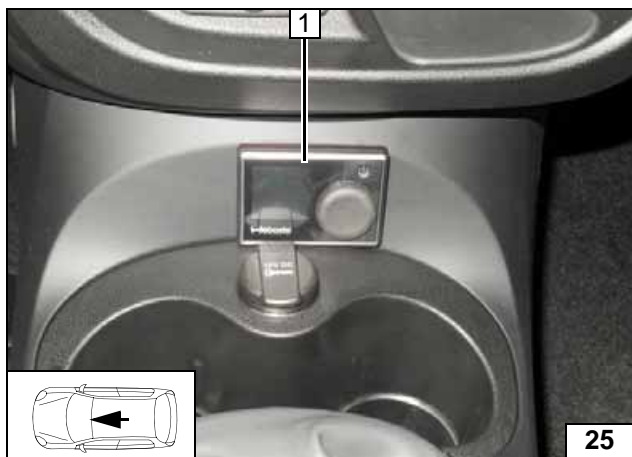

MultiControl CAR Option

- 1 MultiControl CAR



Installing
MultiControl
CAR

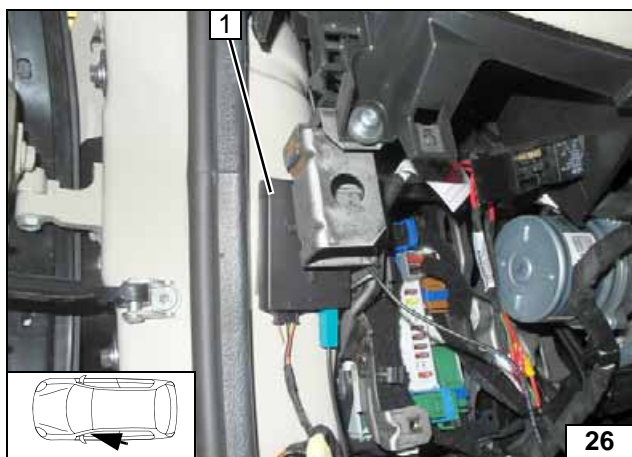

Remote Option (Telestart)

Degrease adhesive base. Fasten receiver 1 with adhesive tape.



Installing
receiver

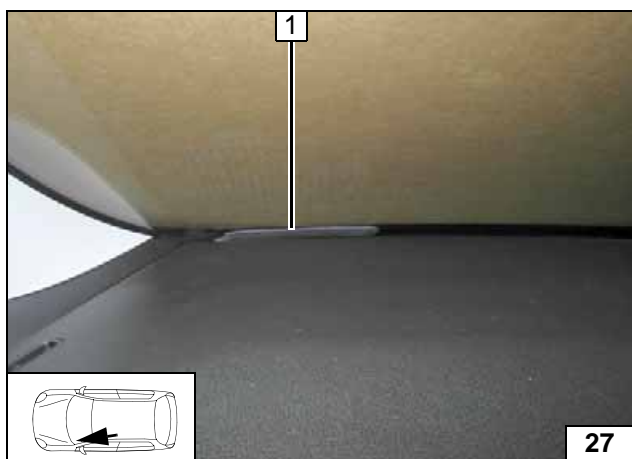

- 1 Antenna

Installing
antenna

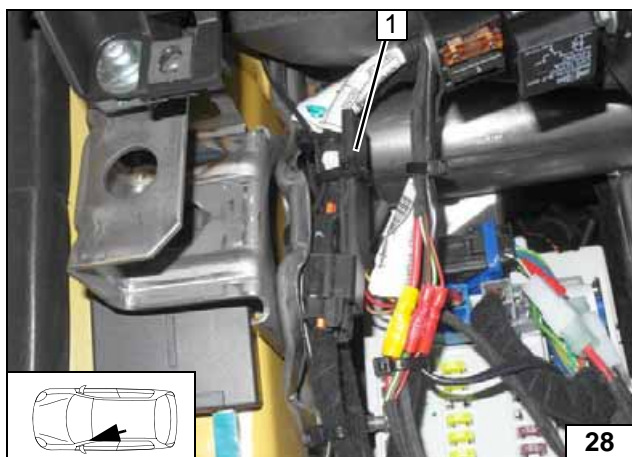

Temperature sensor T100 HTM

Fasten temperature sensor 1 with cable tie.



Installing
temperature
sensor

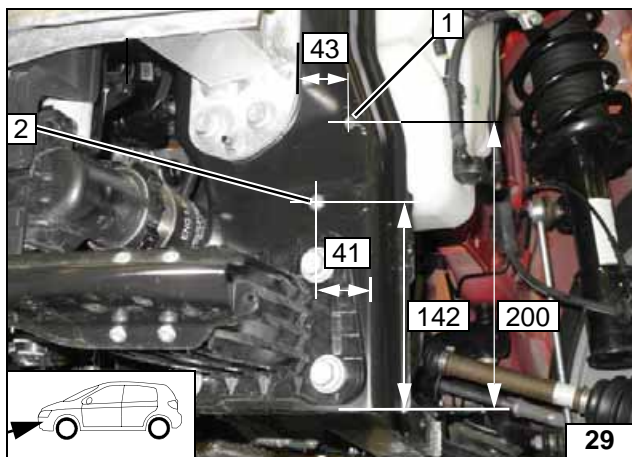

Preparing Installation Location

- 1 7 mm dia. hole
- 2 9.1 mm dia. hole, rivet nut

Installing rivet nut

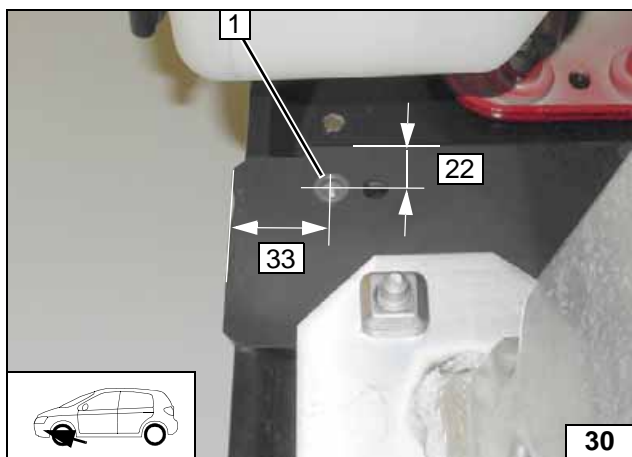

- 1 9.1 mm dia. hole, rivet nut

Installing rivet nut

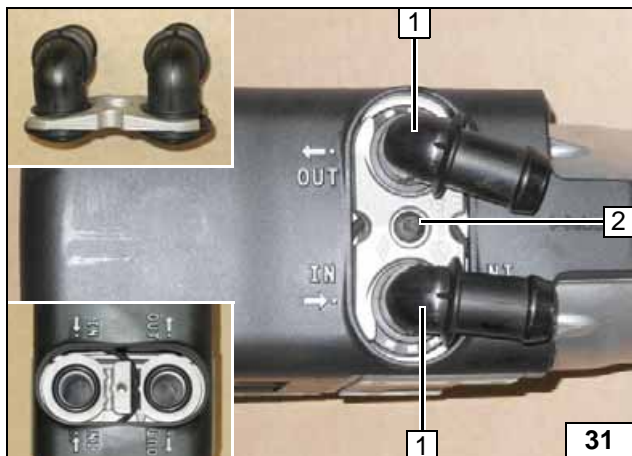

Preparing Heater

- 1 Water connection piece, sealing ring [2x each]
- 2 5x15 self-tapping bolt, retaining plate of water connection pieces



Installing water connection pieces

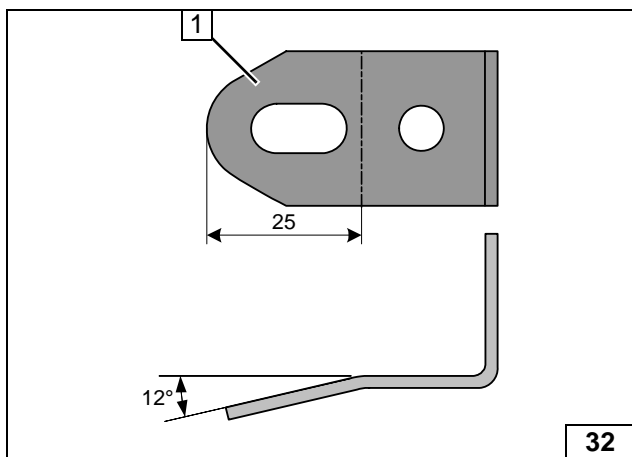

- 1 Angle bracket

Preparing angle bracket

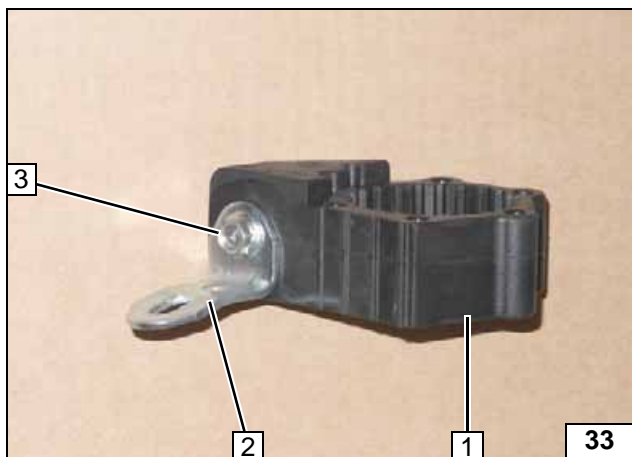

- 1 Circulating pump mounting
- 2 Angle bracket
- 3 M6x25 bolt, flanged nut

Installing angle bracket

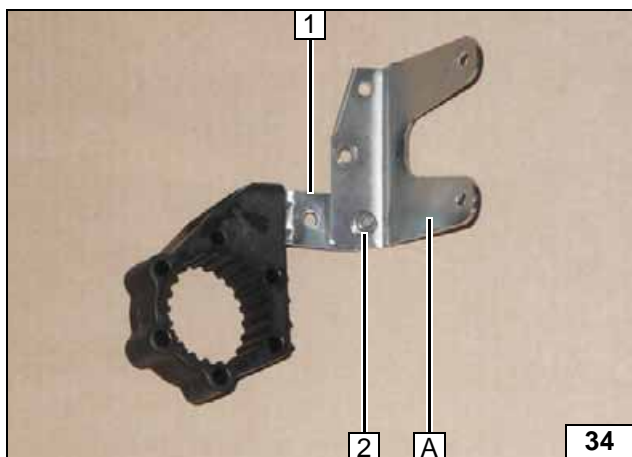

Prepare bracket **A** in accordance with the template!

- 1 Angle bracket
- 2 M5x12 bolt, flanged nut



Premounting bracket **A**

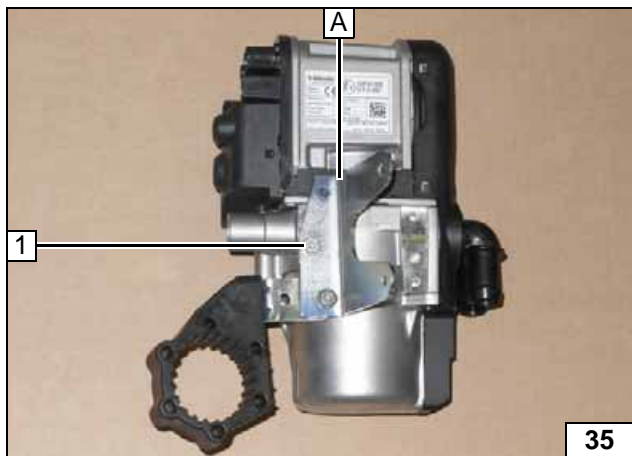

- A** Bracket
- 1 5x13 self-tapping bolt

Installing bracket **A**

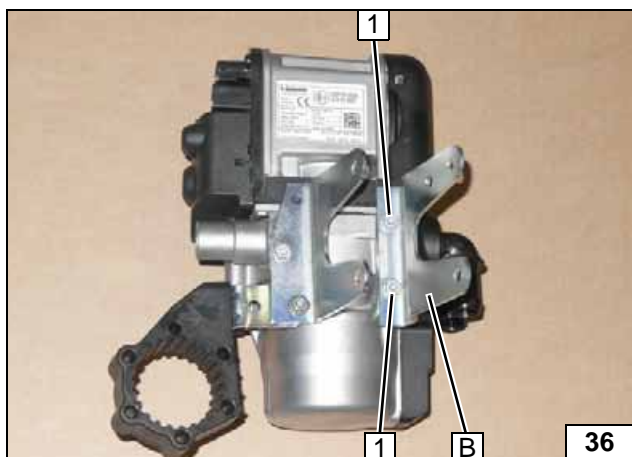

Prepare bracket **B** in accordance with the template!

- 1 5x13 self-tapping bolt [2x]



Installing bracket **B**

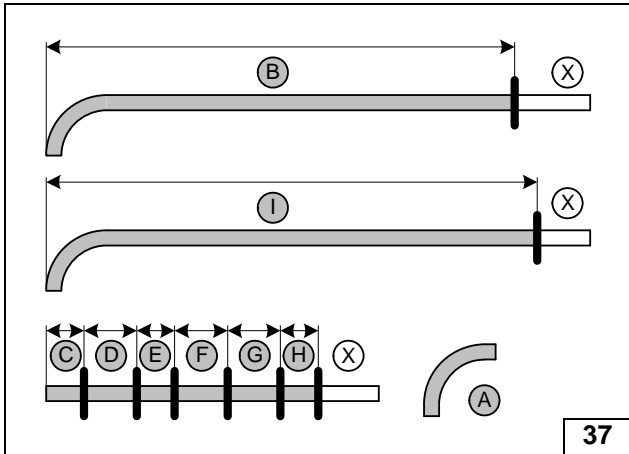
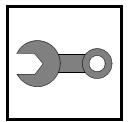

Hose **A** = 90°, 15x18mm dia. moulded hose
 Hose **B** / **I** = 90°, 15mm dia. hose
 Hose **C** - **H** = 18mm dia. straight hose
 Discard sections **X**.

- B** = 915
- C** = 60
- D** = 130
- E** = 60
- F** = 100
- G** = 120
- H** = 85
- I** = 940



Cutting hoses to length

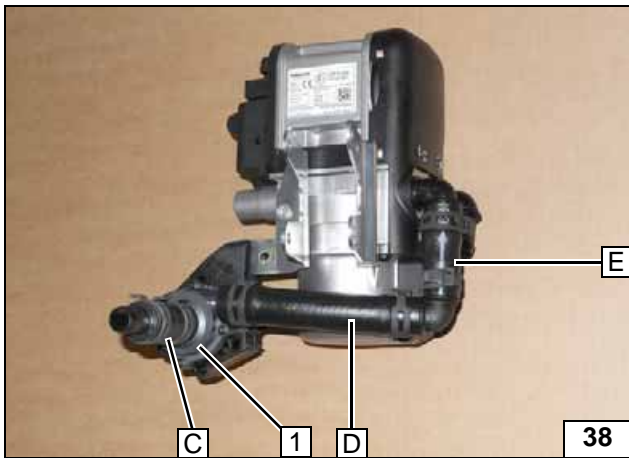

All spring clips = 25mm dia.
 All connecting pipes = 18x18 mm dia.
 Install circulating pump **1** in mounting.



Installing hoses C, D, and E

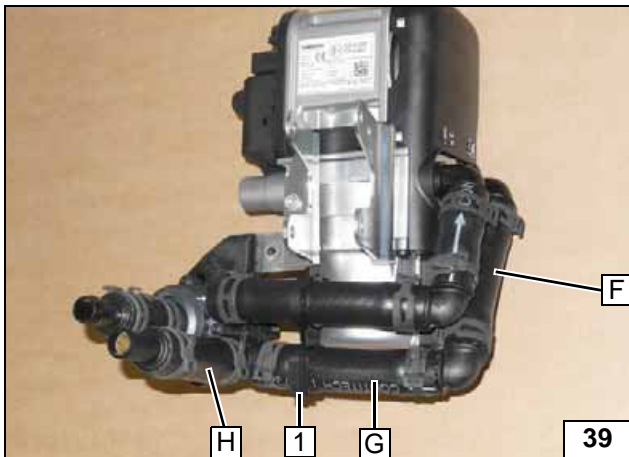

All spring clips = 25mm dia.
 All connecting pipes = 18x18 mm dia.

- 1** Spacer bracket between hose **D** and hose **G**



Installing hoses F, G and H

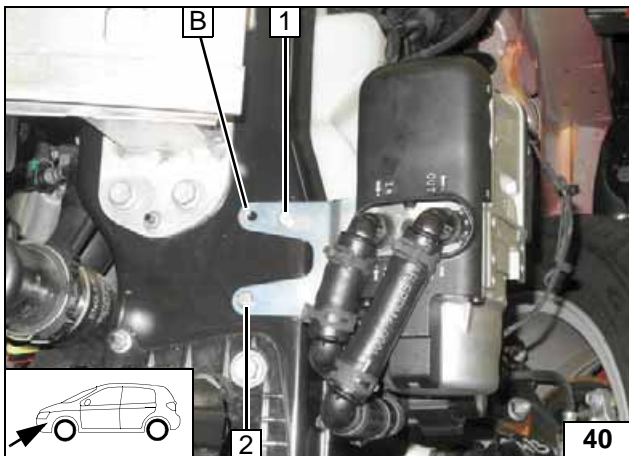

Installing Heater

- B** Bracket
- 1** Insert M6x50 bolt
- 2** M6x20 bolt, spring lockwasher

Installing heater

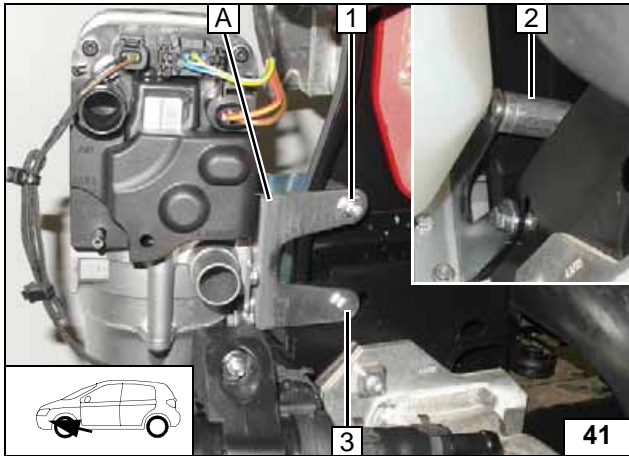

Add a 30mm and a 5mm shim 2 onto M6x50 bolt at position 1.

- A Bracket
- 1 30mm shim, 5mm shim, bracket, flanged nut
- 3 M6x20 bolt, spring lockwasher

Installing heater

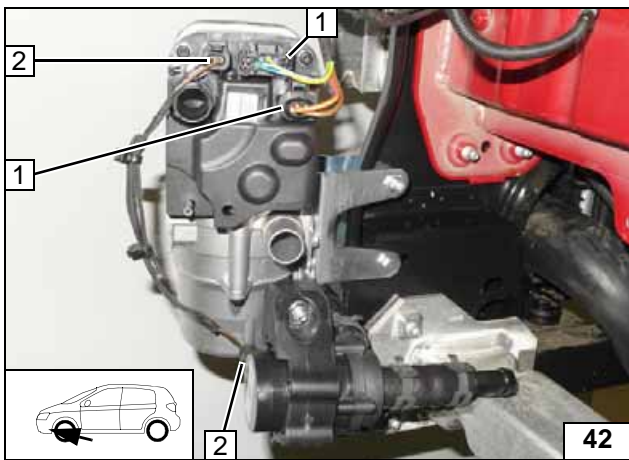

- 1 Connector of heater wiring harness [2x]
- 2 Connector of circulating pump wiring harness [2x]

Mounting wiring harness





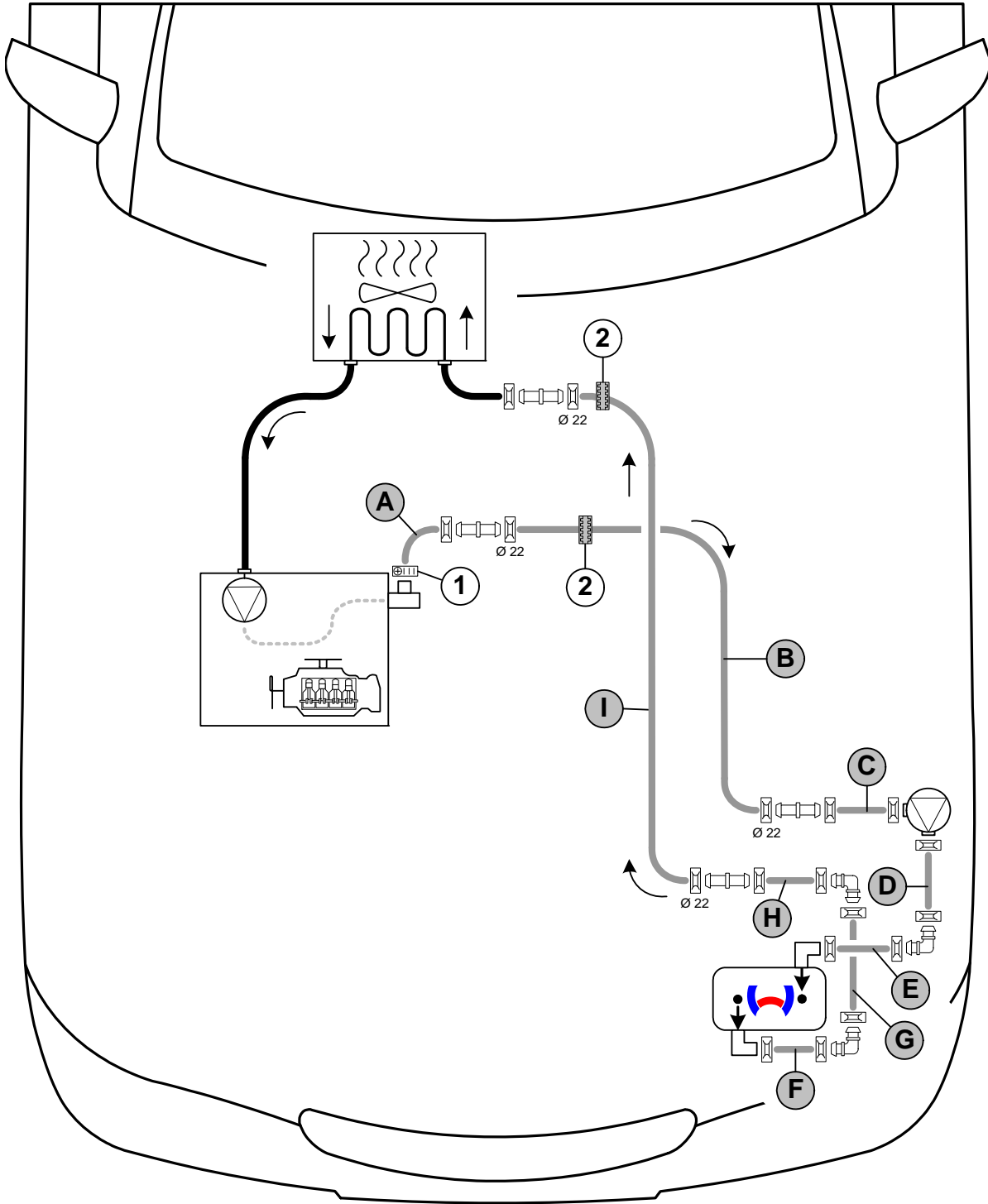

Coolant Circuit

WARNING!

Any coolant running off should be collected in an appropriate container. Install hoses so that they are kink-free. Unless specified otherwise, always fasten using cable ties. Position clamps so that other hose cannot be damaged. When installing the hoses, the heater must be filled with coolant. The connection should be modelled on an "inline" circuit and based on the following diagram:



Hose routing diagram

All spring clips without specific designation  = 25mm dia. 1 = Hose clamp  = 16-27mm dia.
 2 = Black (sw) rubber isolator . All connecting pipes  = 18x18mm dia. All connecting pipes  = 15x18mm dia.



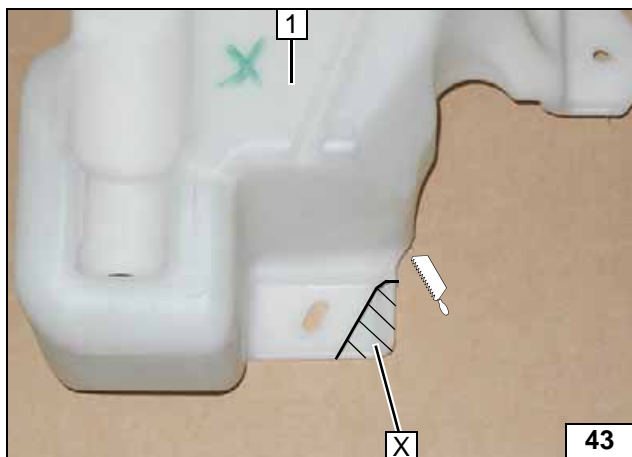
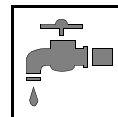

Cut off marked section of washer reservoir 1. Discard section X.



Preparing washer reservoir

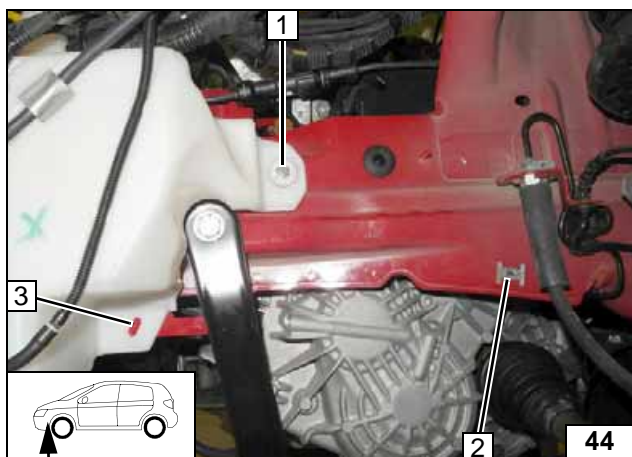

Insert rivet nut in existing hole at position 1. Install bolt at position 3, will be tightened later.



- 1 M6x20 bolt, large diameter washer on rivet nut
- 2 Remove bracket for self-tapping screw

Installing washer reservoir

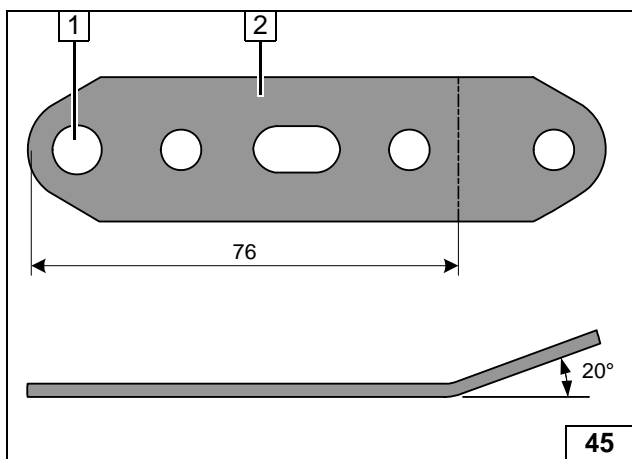

- 1 8mm dia. hole
- 2 Perforated bracket



Preparing perforated bracket

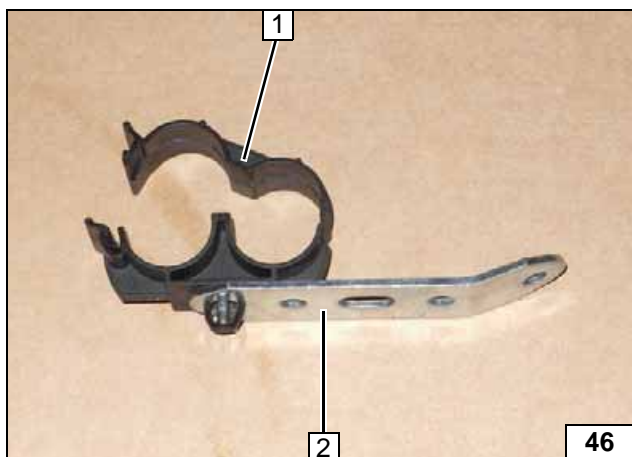

- 1 Hose bracket in 8mm dia. hole
- 2 Perforated bracket

Preparing hose bracket



Mount perforated bracket **2** with plastic nut on original vehicle stud bolt **1** as shown!

Installing perforated bracket

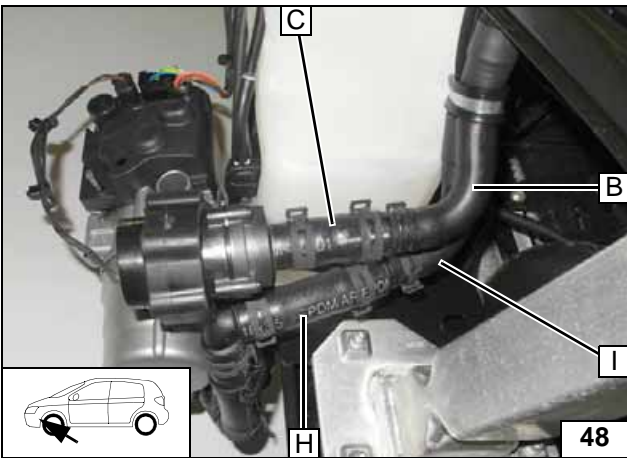
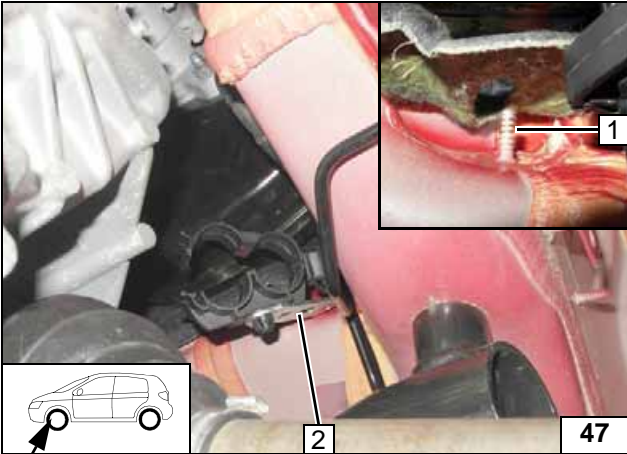

Routing in engine compartment

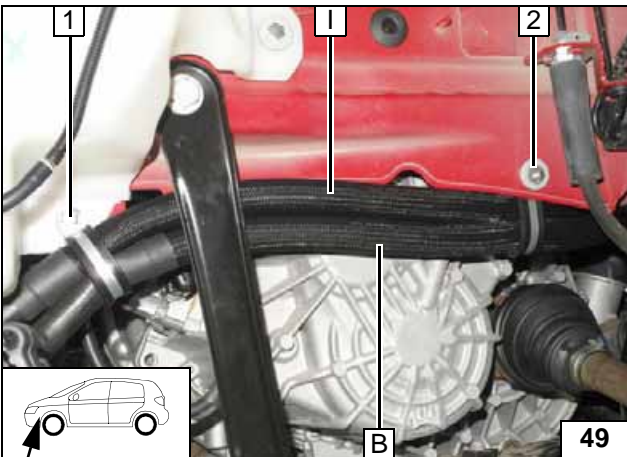

- 1 M6x20 bolt, 34mm dia. rubber-coated p-clamp, flanged nut
- 2 M6x20 bolt, 34mm rubber-coated p-clamp, large diameter washer, pin lock

Routing in engine compartment

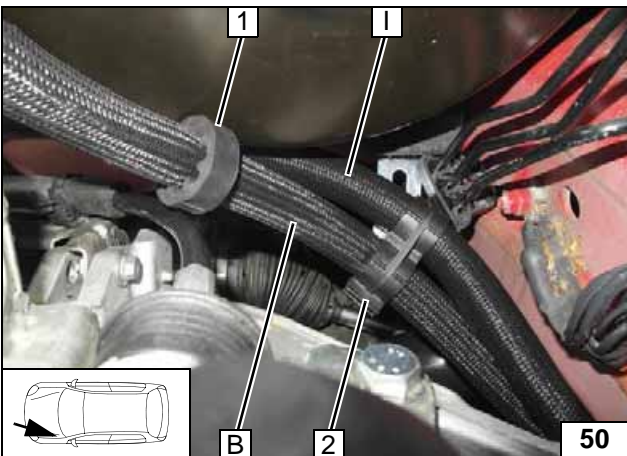

Slide black (sw) rubber isolator **1** onto hose **B**.

- 2 Lock hose bracket



Routing in engine compartment

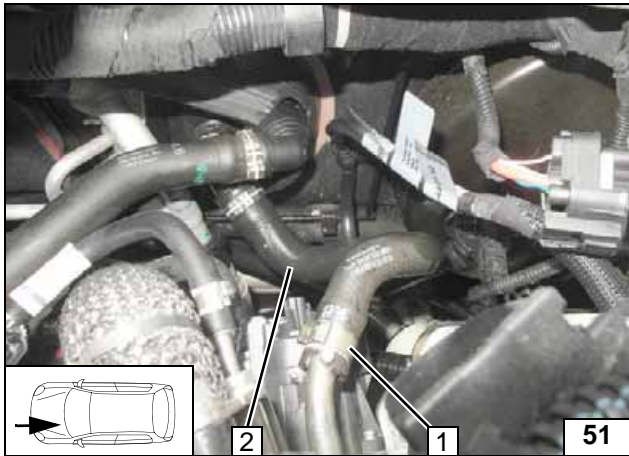

Remove original vehicle hose of engine inlet / heat exchanger outlet **2**. Discard original vehicle clamp **1**.

Cutting point

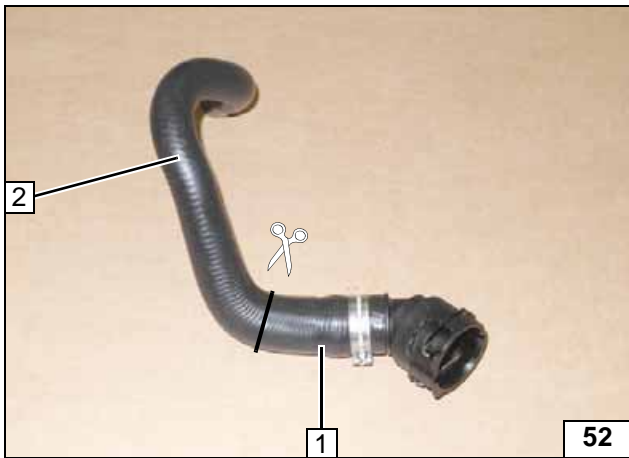

- 1 Hose section of heat exchanger inlet
- 2 Discard hose section of engine outlet

Cutting point

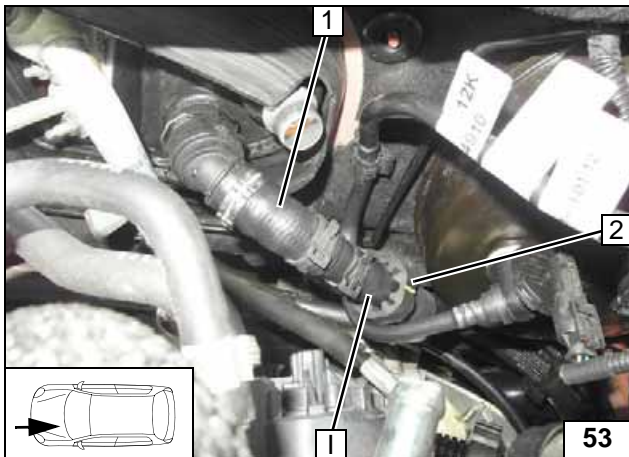

Hose of heat exchanger outlet removed for demonstration purposes only. Slide black (sw) rubber isolator **2** onto hose **1** and align with original vehicle line.



- 1 Hose section of heat exchanger inlet

Connecting heat exchanger inlet

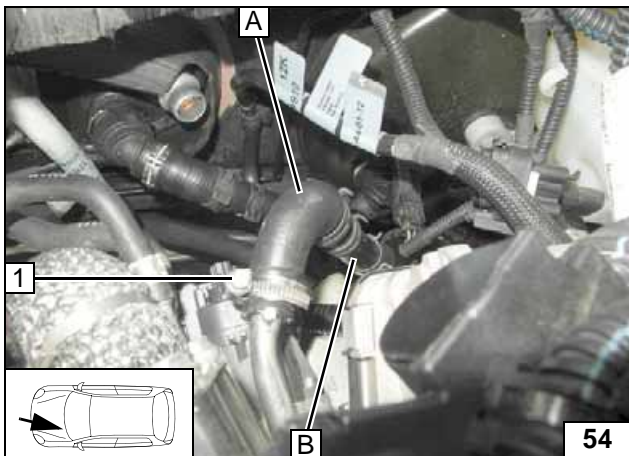

- 1 Hose clamp

Connecting engine outlet

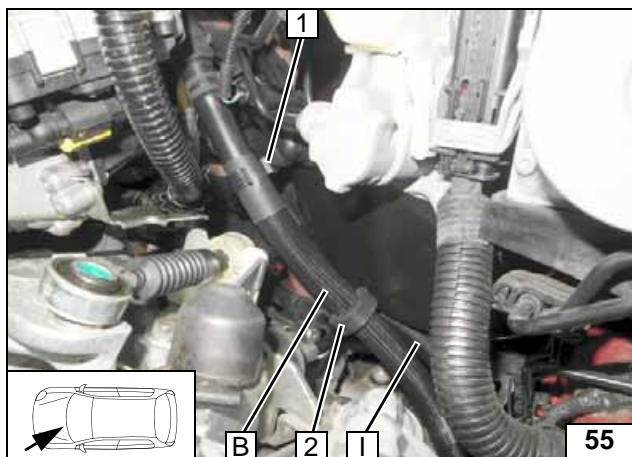

Ensure sufficient distance from neighbouring components, correct if necessary.



- 1 Hose bracket between hose **B** and hose **I**
- 2 Align black (sw) rubber isolator with brake booster

Aligning hoses

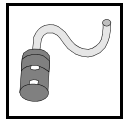

**Premount-
silencer**

Combustion Air

- 1 Combustion air silencer
- 2 51 mm dia. clamp
- 3 Angle bracket
- 4 M5x16 bolt, flanged nut
- 5 Combustion air pipe

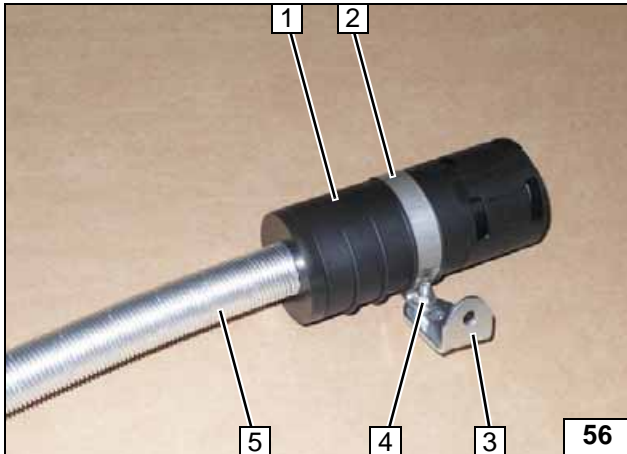

- 1 Combustion air pipe
- 2 Cable tie

**Installing
combus-
tion air pipe**

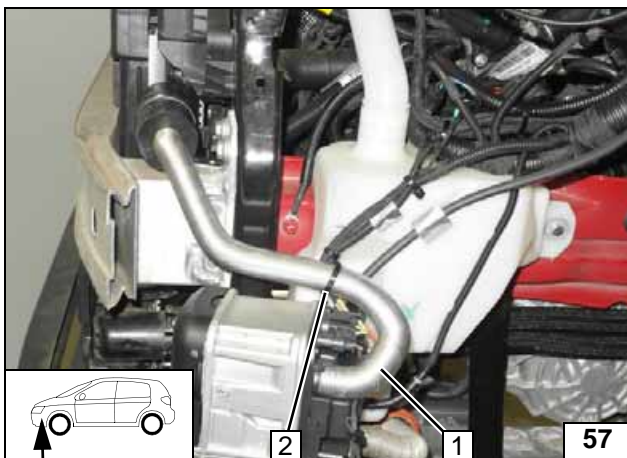

- 1 Combustion air silencer
- 2 Original vehicle nut
- 3 Angle bracket



**Installing
silencer**

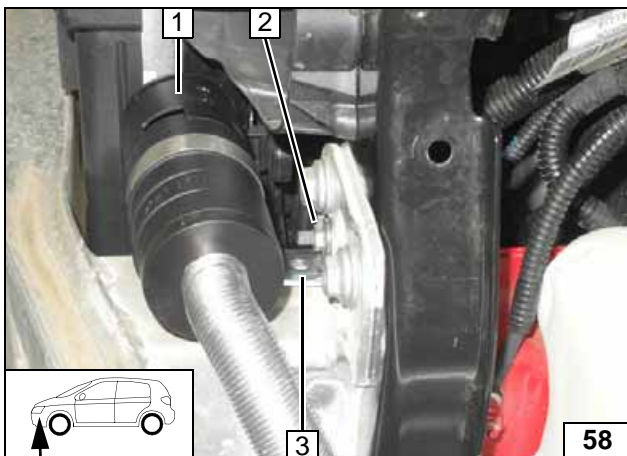

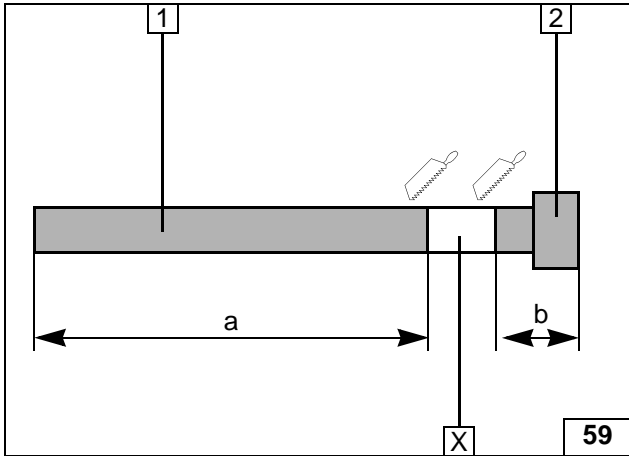
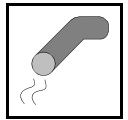

Exhaust Gas

Discard section X.

- 1 Exhaust pipe
a = 400
- 2 Exhaust end section
b = 50



Preparing exhaust pipe

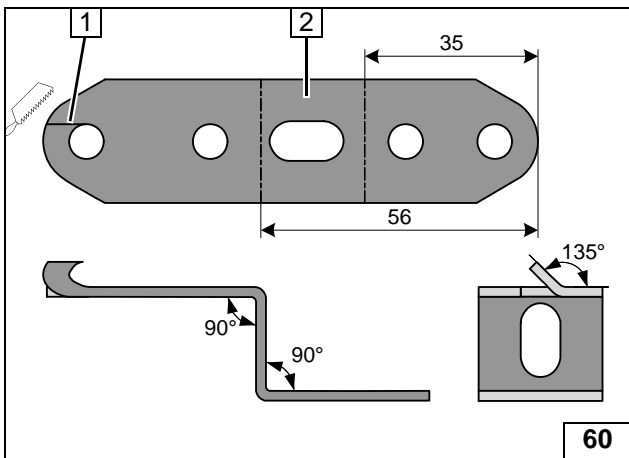

Saw perforated bracket 2 in position 1 until the hole and angle down by 45° to form a twist protection.



Preparing perforated bracket

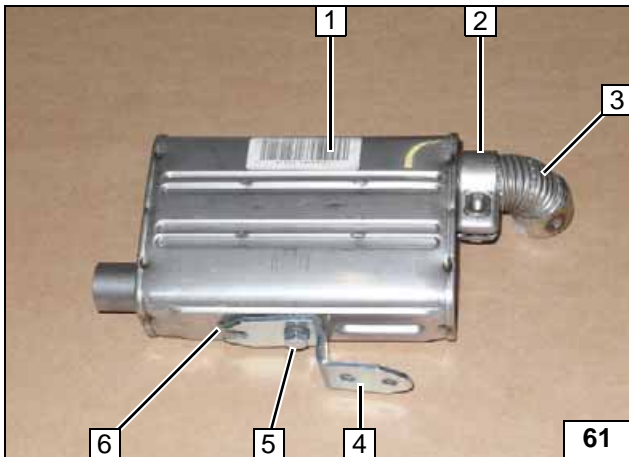

- 1 Silencer
- 2 Hose clamp
- 3 Exhaust end section
- 4 Perforated bracket
- 5 M6x16 bolt, spring lockwasher
- 6 Twist protection in bead

Premounting silencer and exhaust end section

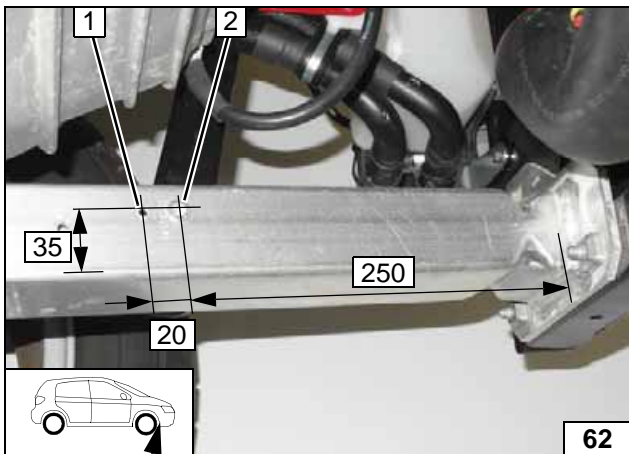

- 1 5mm dia. hole
- 2 9.1 mm dia. hole, rivet nut

Installing rivet nut

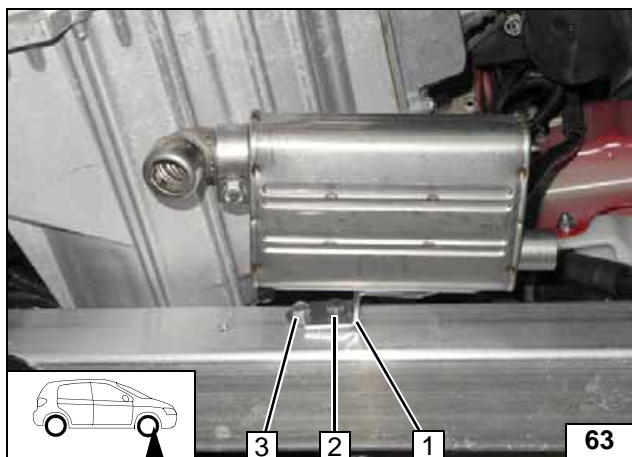
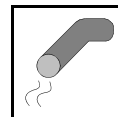

- 1 Perforated bracket
- 2 M6x20 bolt, spring lockwasher
- 3 5.5x13 self-tapping screw

Installing
exhaust si-
lencer

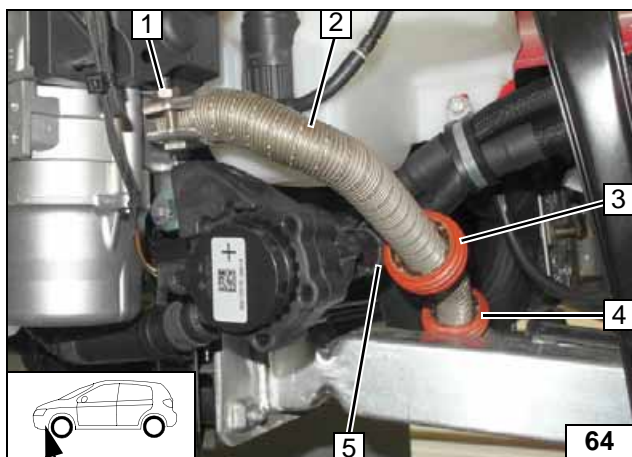

Slide spacer bracket 3 onto exhaust pipe 2 and align in position 5 with hose C. Slide spacer bracket 4 onto exhaust pipe 2.

- 1 Hose clamp



Installing
exhaust
pipe

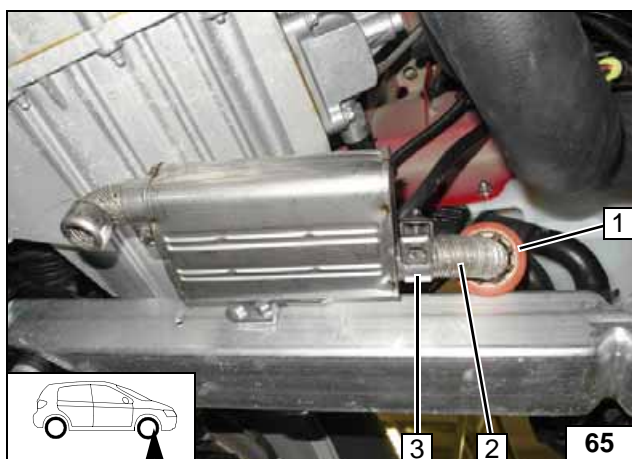

Align spacer bracket 1 with frame side member.

- 2 Exhaust pipe
- 3 Hose clamp



Installing
exhaust
pipe

Fiat 500L

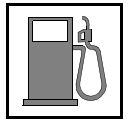

Fuel

CAUTION!

Open the vehicle's fuel tank cap, ventilate the tank and then re-close the tank lock.

Catch any fuel running off in an appropriate container.

Install fuel line and metering pump wiring harness so that they are protected against stone impact. Unless specified otherwise, always fasten using cable ties. Provide rub protection for fuel line and wiring harness in areas where there are sharp edges.

WARNING!

The fuel line and wiring harness are routed to the metering pump as shown in the wiring harness routing diagram.



Connect-
ing heater



Installing
lines



Installing
lines

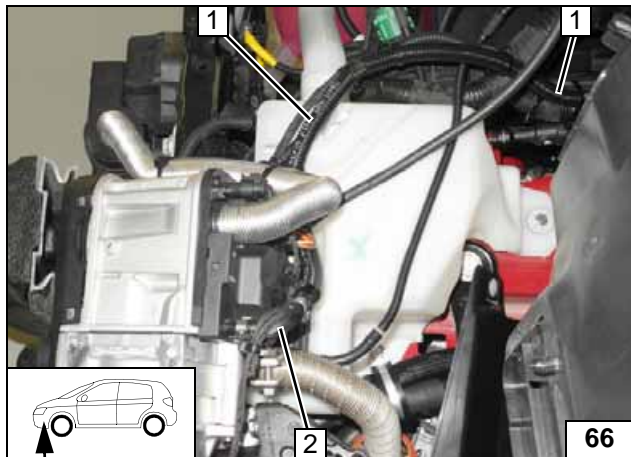

Pull fuel line and wiring harness of metering pump in 10mm dia. corrugated tube 1 and route in the engine compartment.

- 2 Fuel line, 90° moulded hose, 10mm dia. clamp [2x]

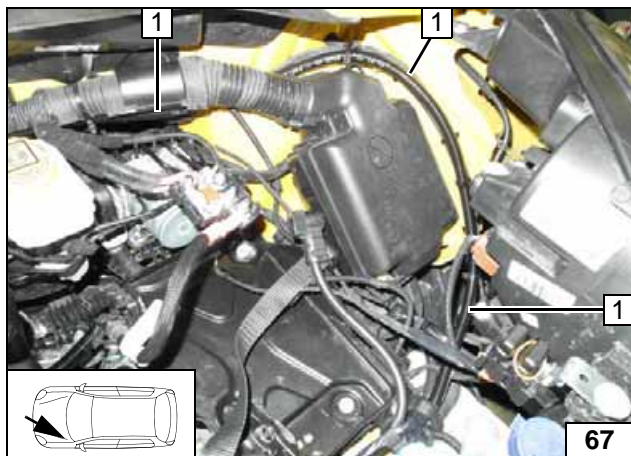

Route fuel line and wiring harness of metering pump into corrugated tube 1 to the fire-wall.

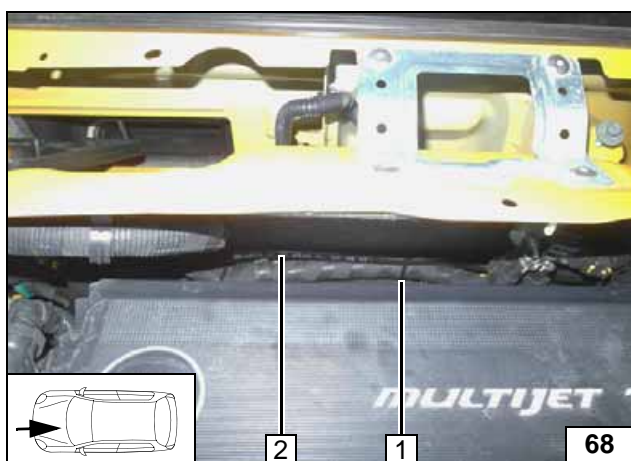

Route fuel line and wiring harness of metering pump in corrugated tube 2 along original vehicle wiring harness to the right side and secure using cable tie 1.

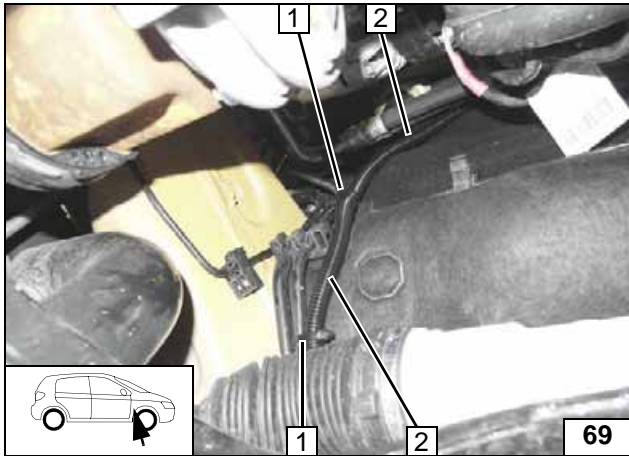

Route fuel line and wiring harness of metering pump in corrugated tube 2 along original vehicle fuel line to the underbody and secure using cable tie 1 [2x].



Installing lines

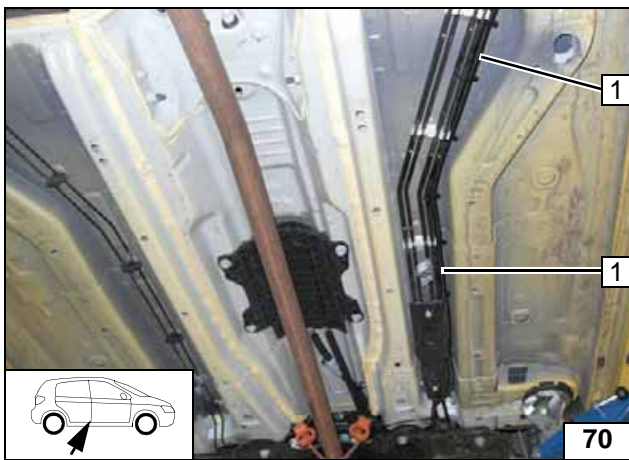

Route fuel line and wiring harness of metering pump 1 along original vehicle lines to the installation location of the metering pump.



Installing lines

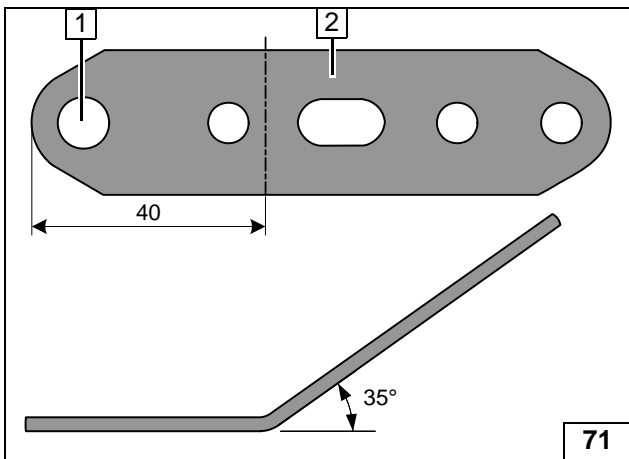

- 1 Drill out hole to 8.5 mm dia.
- 2 Perforated bracket



Preparing perforated bracket

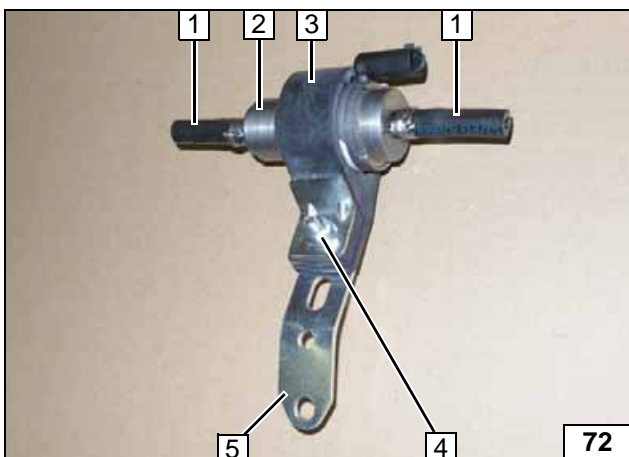

- 1 Hose section, 10mm dia. clamp [2x each]
- 2 Metering pump
- 3 Mounting of metering pump
- 4 M6x25 bolt, support angle bracket and flanged nut
- 5 Perforated bracket

Premounting metering pump

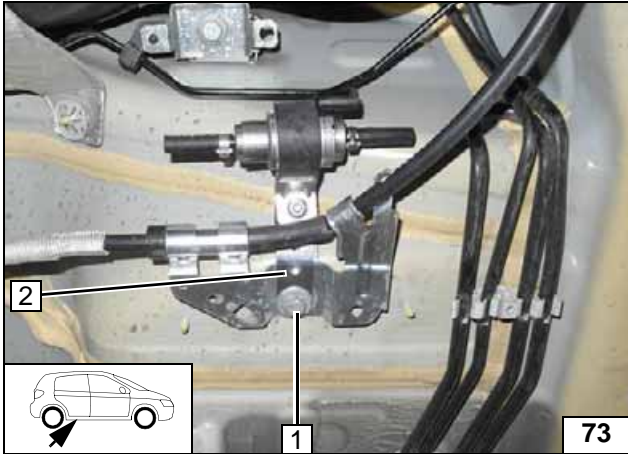
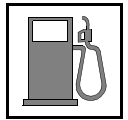

- 1 Original vehicle bolt
- 2 Perforated bracket

Installing metering pump

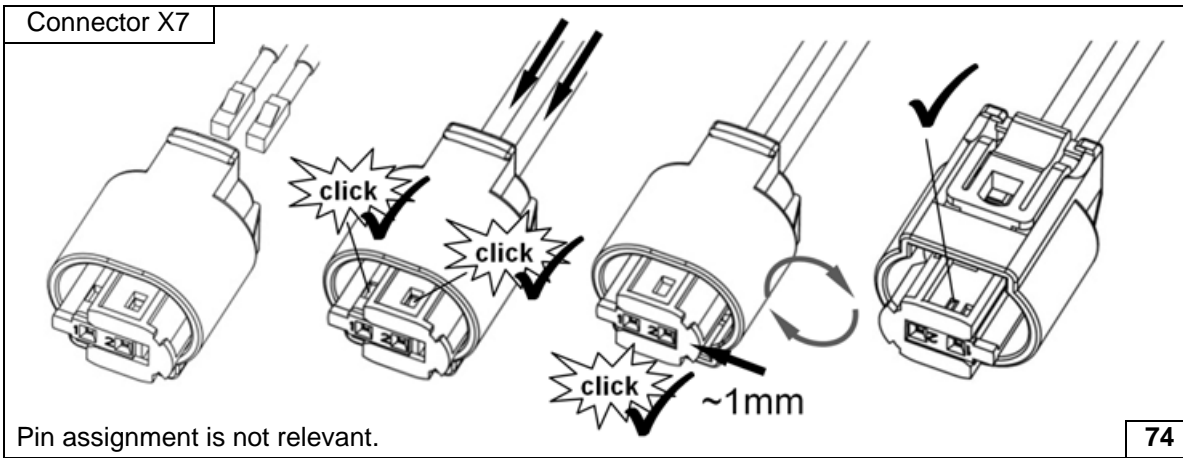

Completing metering pump connector

Pin assignment is not relevant.

74

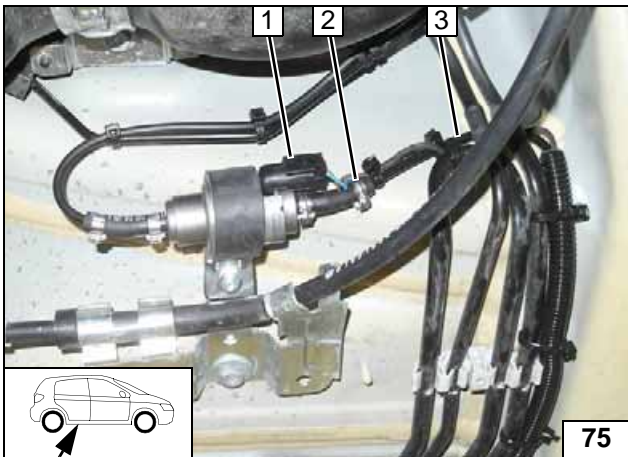

- 1 Wiring harness of metering pump, connector X7 mounted
- 2 10mm dia. clamp
- 3 Fuel line of heater

Connecting metering pump

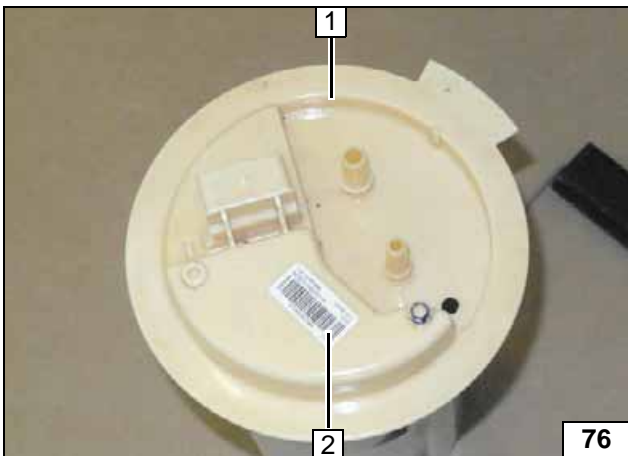

Remove fuel-tank sending unit 1 in accordance with the manufacturer's instructions. Remove sticker 2.



Fuel extraction



Copying hole pattern



Installing fuel standpipe



Connecting fuel line



Connecting metering pump

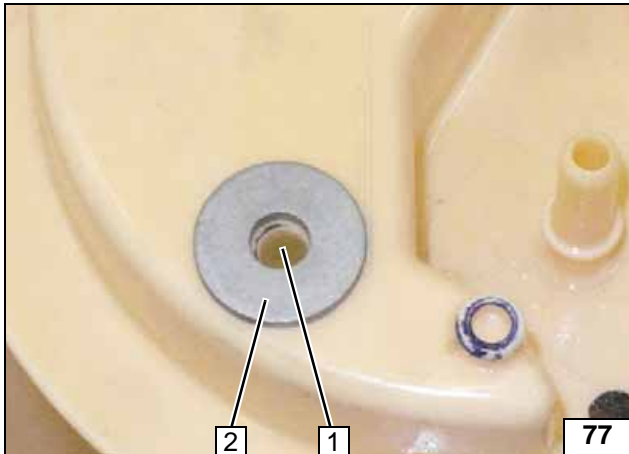

Position large diameter washer with outer dia. $d_a = 21.6\text{mm}$ 2 as shown and copy hole pattern.

1 6 mm dia. hole

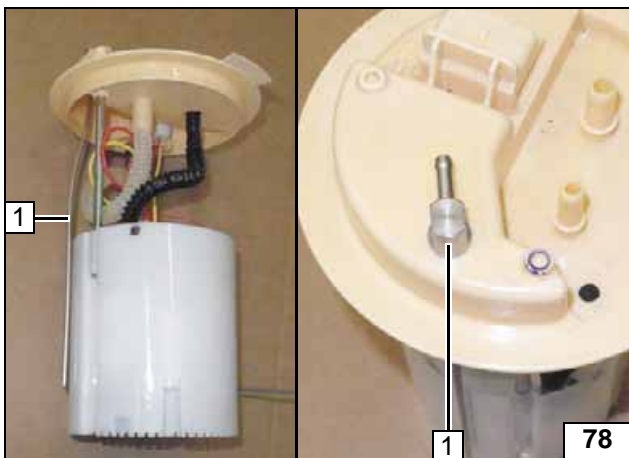

Shape fuel standpipe 1 according to template and cut to length.

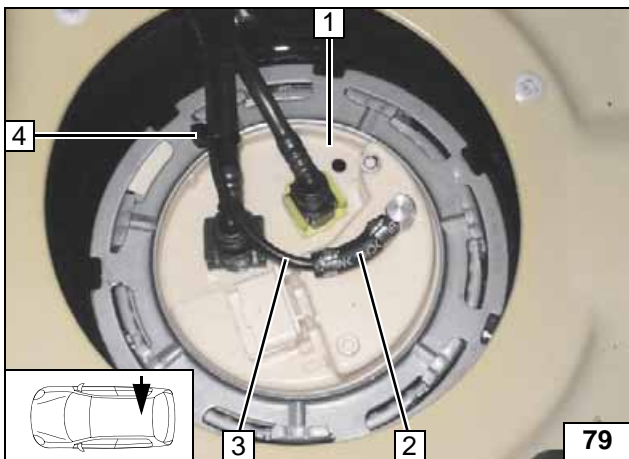

Install fuel-tank sending unit 1 in accordance with manufacturer's instructions.

- 3 Fuel line of fuel standpipe
- 2 Hose section, 10mm dia. clamp [2x]
- 4 Cable tie

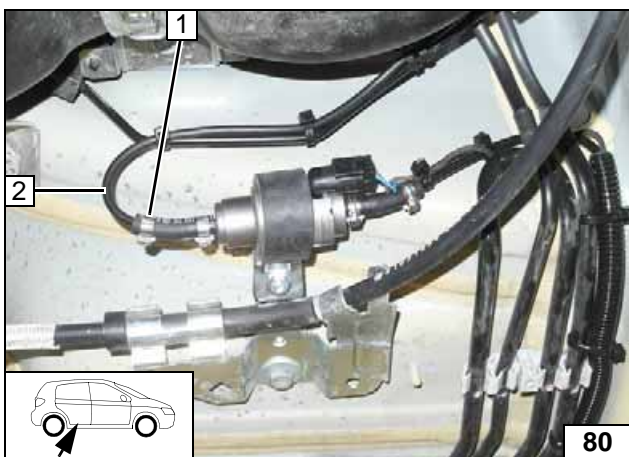

Ensure sufficient distance from neighbouring components, correct if necessary.

- 1 10mm dia. clamp
- 2 Fuel line of fuel standpipe

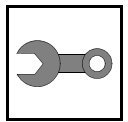

Final Work

WARNING!

Mount removed parts in reverse order. Check all hoses, clamps and all electrical connections for firm seating. Insulate all loose wires and tie back.

Only use manufacturer-approved coolant. Spray the heater components with anti-corrosion wax (Tectyl 100K, Order No. 111329).



- **Connect the battery.**
- **Fill and bleed the coolant circuit according to the vehicle manufacturer's specifications.**
- **Program MultiControl CAR, teach telestart transmitter.**
- **Make settings on A/C control panel according to the "Operating Instructions for the End Customer".**
- **Place the "Switch off parking heater before refuelling" caution label in the area of the filler neck.**
- **For initial startup and function check, please see installation instructions**

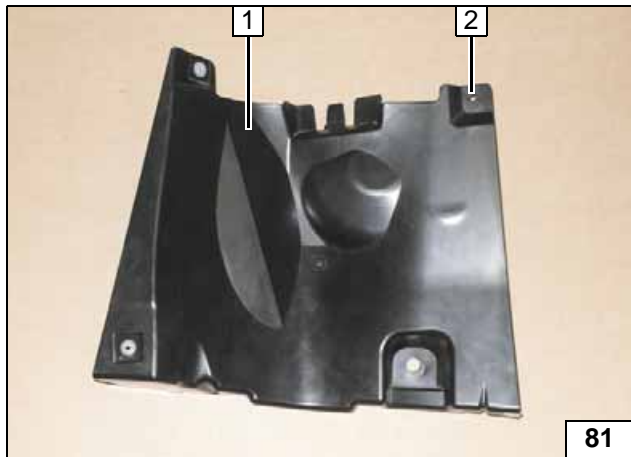

Final Work

- 1 Wheel well trim
- 2 Drill out hole to 6.5mm dia.

Cutting wheel well trim

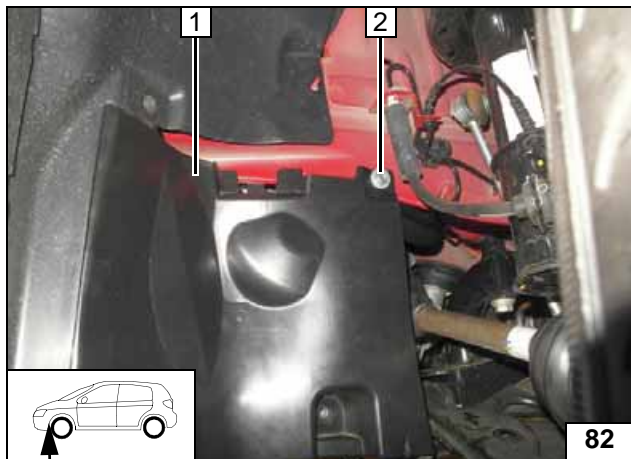

- 1 Wheel well trim
- 2 Large diameter washer, M6 flanged nut on M6x20 bolt

Installing wheel well trim

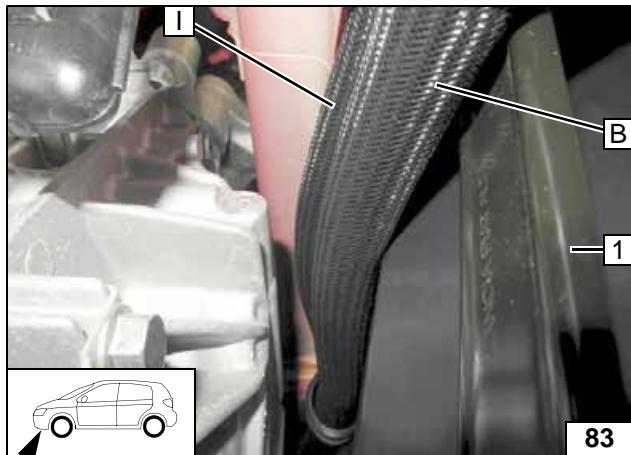

Align hoses **B** and **I** with wheel well trim **1**, avoid kinks, correct if necessary.



Aligning hoses

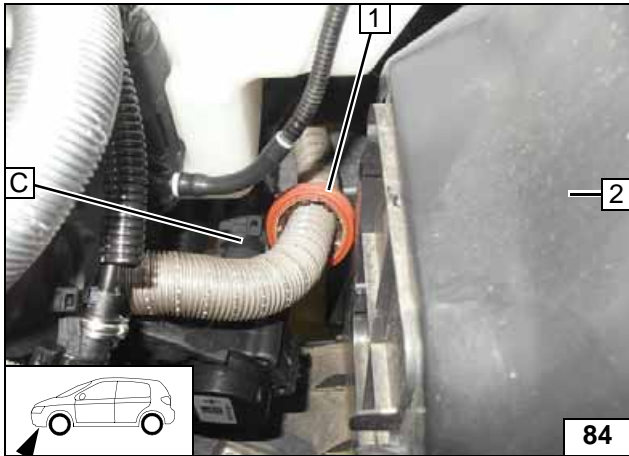

Align spacer bracket 1 between wheel well trim 2 and hose C.

2 Wheel well trim



Aligning spacer bracket

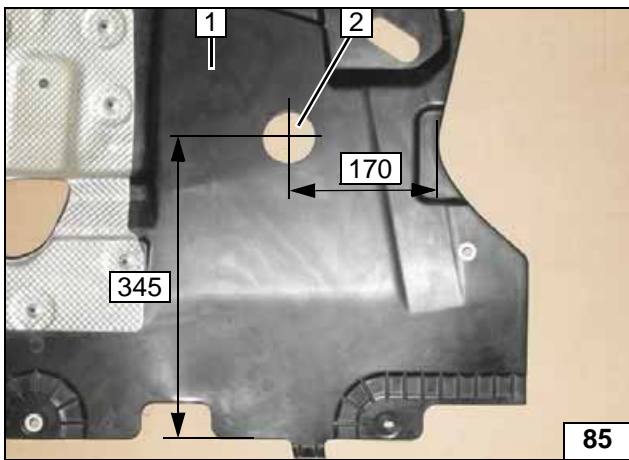

1 Underride protection
2 60 mm dia. hole

Cutting out underride protection

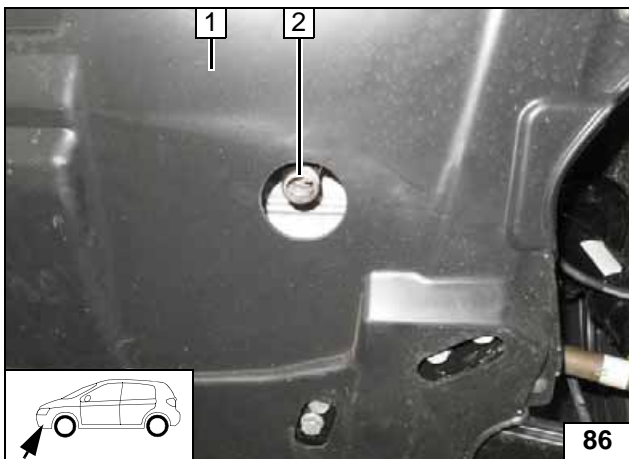

Mount underride protection 1. Align exhaust end section 2 with the centre of the hole and flush with underride protection 1.



Aligning exhaust end section

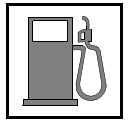

Template for Fuel Standpipe

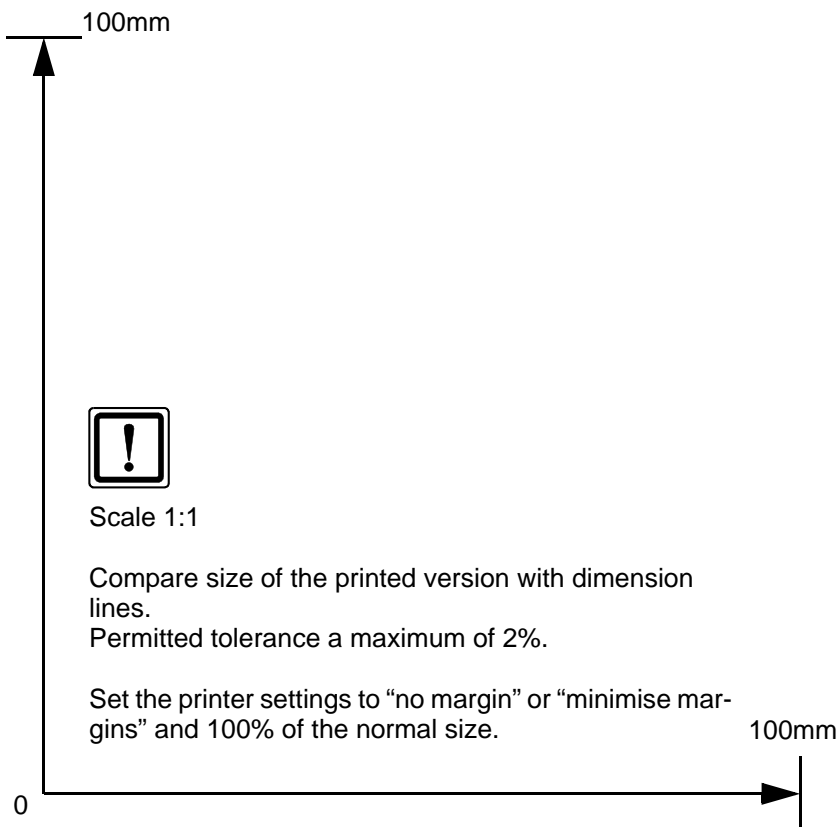
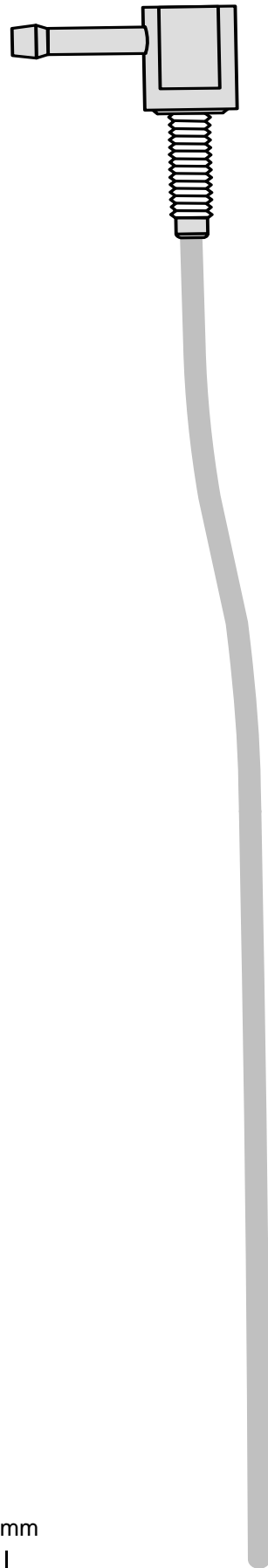

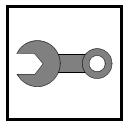

Template for Bracket

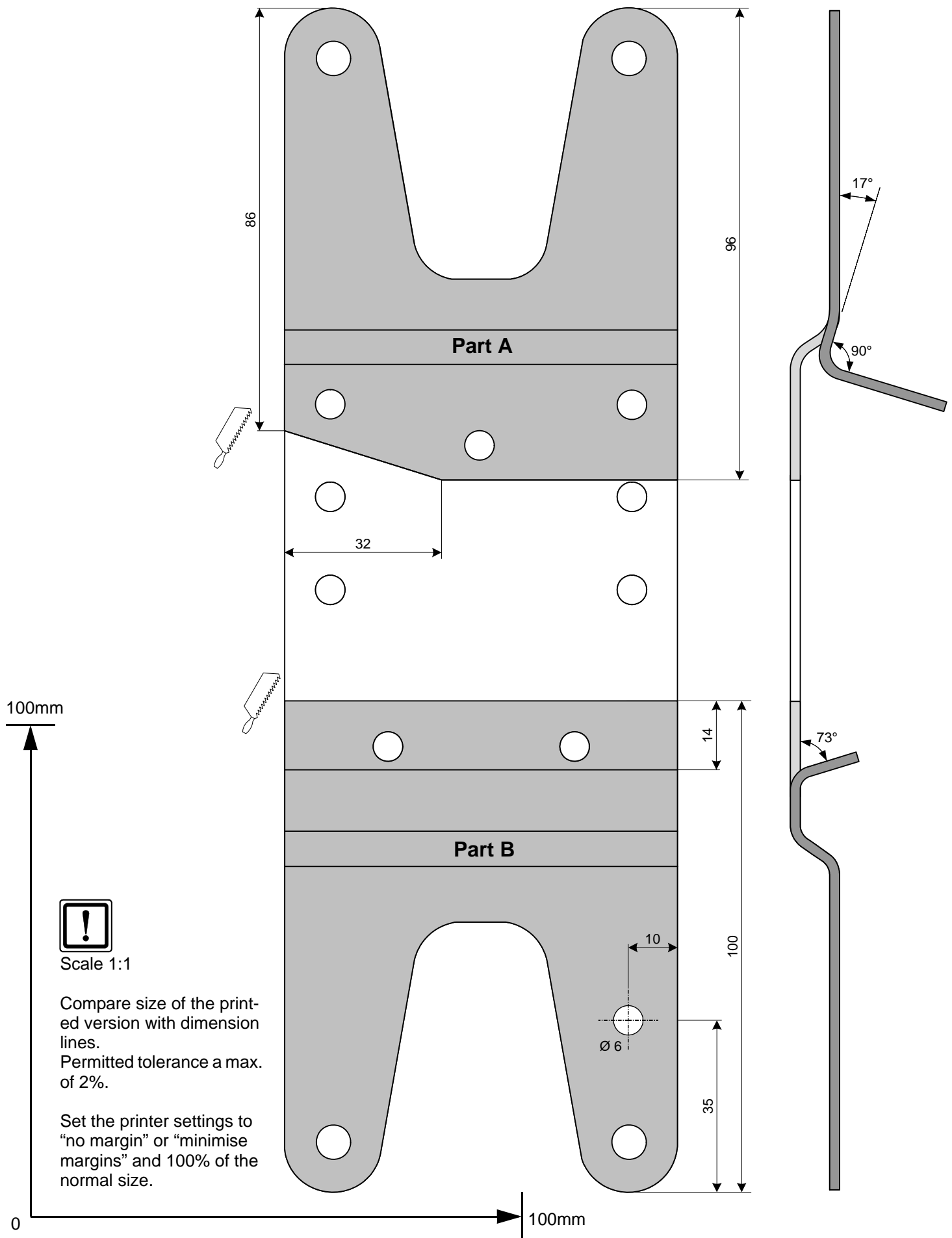

Operating Instructions for Manual Air-Conditioning

Please remove page and add to the vehicle operating instructions.

Note:

We recommend matching the heating time to the driving time.
 Heating time = driving time

Example:

For a driving time of approx. 20 min. (in one direction), we recommend not exceeding a switch-on time of 20 min.

Passenger compartment monitoring, if installed, must be deactivated in addition to the vehicle settings for the heating operation.

For instructions on deactivation, please refer to the operating instructions of the vehicle.

Before parking the vehicle, make the following settings:

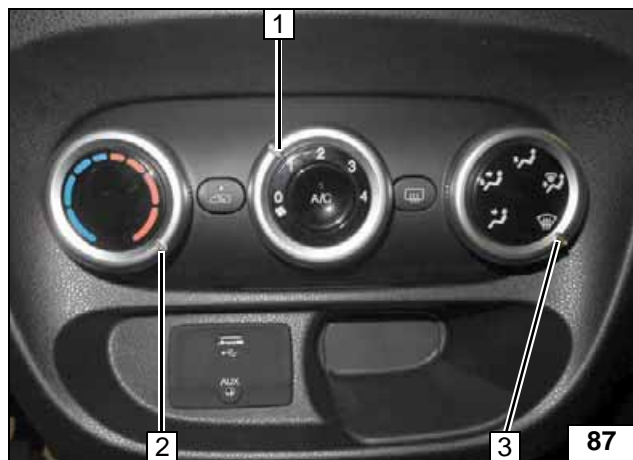

- 1 Set fan to level "1", or max. "2"
- 2 Set temperature to "max."
- 3 Air outlet onto windscreen



A/C control panel



- 1 20A heater fuse F1
- 2 30A main fuse F2 of passenger compartment

Engine compartment fuses

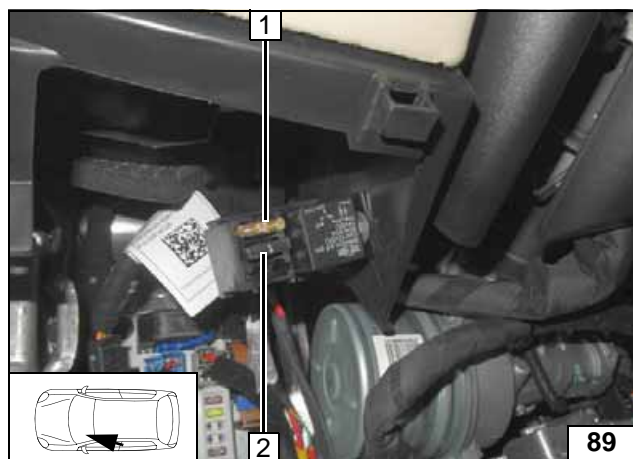

- 1 25A fan fuse F4
- 2 1A fuse F3 of heater control

Passenger compartment fuses

Operating Instructions for Automatic Air-Conditioning

Please remove page and add to the vehicle operating instructions.

Note:

We recommend matching the heating time to the driving time.
Heating time = driving time

Example:

For a driving time of approx. 20 min. (in one direction), we recommend not exceeding a switch-on time of 20 min.

Passenger compartment monitoring, if installed, must be deactivated in addition to the vehicle settings for the heating operation.

For instructions on deactivation, please refer to the operating instructions of the vehicle.

Before parking the vehicle, make the following settings:



Note:

The fan speed need not be preset!

- 1 Set temperature on both sides to "32.0°C"
- 2 Air outlet faces "upward"



A/C control panel



- 1 20A heater fuse F1
- 2 30A main fuse F2 of passenger compartment

Engine compartment fuses

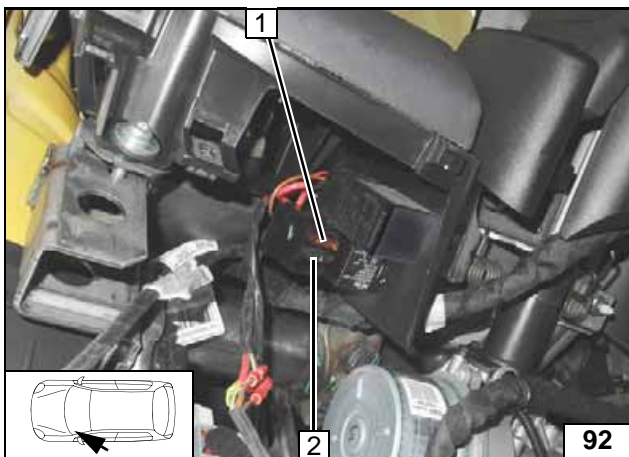

- 1 5A fan fuse F4
- 2 1A fuse F3 of heater control

Passenger compartment fuses