

Water Heater Unit



Thermo Top C Additional Heater ^{e1}_{00 0002}

Thermo Top P Additional Heater ^{e1}_{00 0104}

Installation Instructions

Dodge Nitro

Diesel
from Model Year 2007
Left-hand drive vehicle



WARNING!

Hazard warning:

Incorrect installation or repair of Webasto heating systems may cause a fire or result in the emission of carbon monoxide, which can be fatal. Serious or fatal injuries can be caused as a result.

Specialist company training, technical documentation, specialized tools and equipment are required to install and repair Webasto heating and cooling systems.

NEVER attempt to install or repair Webasto heating or cooling systems if you have not successfully completed the company training and thereby acquired the required technical skills, or if you do not have access to the required technical documentation, tools and equipment needed to carry out correct installation and repairs.

ALWAYS follow all Webasto installation and repair instructions and observe all warnings.

Webasto does not accept any liability for defects and damage that are attributable to installation by untrained staff.

Table of Contents

Validity	2	Preparing bracket	9
Heater Unit/Installation Kit	3	Preparing installation location	9
Foreword	3	Preparing heater unit	10
General Instructions	3	Installing heater unit	11
Special Tools	3	Coolant connection	12
Explanatory Notes on Document	4	Exhaust gas	15
Preliminary Work	5	Fuel	18
Heater unit installation location	5	Combustion air	21
Electrical system	6	Final Work	22
Fan controller for manual air conditioning	7	Operating Instructions for End Customer	24
Remote option (Telestart)	8	Template for Fuel Standpipe	25

Validity

Manufacturer	Model	Type	EG-BE No./ABE
DaimlerChrysler (USA)/Chrysler (USA)	Dodge Nitro	KJ	e4*2001/116*0122*...

Engine type	Engine model	Output in kW	Displacement in cm ³
51C/52C	Diesel	130	2777

Vehicle and engine types, equipment variants and national specifications not listed in these installation instructions have not been tested. However, installation according to these installation instructions may be possible.

The installation location of a digital timer and summer/winter switch should be confirmed with the end customer before installation.

Heater Unit/Installation Kit

Quantity	Description	Order No.:
1	Retail accessories with desired heater control	See price list
1	Installation kit for Dodge Nitro Diesel	1312800A

Heater unit recommended for the respective vehicle class:

Vehicle	Heater unit
Compact car	Thermo Top E
Mid-size car, station wagon	Thermo Top C
Full-size car, van, offroader	Thermo Top P

The selection of the heater unit is based on the passenger compartment size of the vehicle and the level of comfort required by the customer!



Foreword

These installation instructions apply to Dodge Nitro Diesel vehicles - for validity, see page 2 - from model year 2007 and later, assuming technical modifications to the vehicle do not affect installation, any liability claims excluded. Depending on the vehicle version and equipment, modifications may be necessary during installation with respect to these installation instructions.

However, the stipulations in the "installation instructions" and "operating and maintenance instructions" for the *Thermo Top C/P/E* must always be observed.

The corresponding rules of technology and any information from the vehicle manufacturer should be observed during the installation work.

General Instructions

Installation should be carried out according to the general, standard rules of technology. Unless specified otherwise, fasten hoses, lines and wiring harnesses to original vehicle lines and wiring harnesses using cable ties.

Sharp edges should be fitted with edge protectors (split-open plastic hose).

Spray unfinished body areas, e.g. drilled holes, with anti-corrosion wax (Tectyl 100K, Order No. 111329).

Special Tools

- Torque wrench for 2.0 - 10 Nm
- Hose clamping pliers
- Metric thread-setter kit

Explanatory Notes on Document

To provide you with a quick overview of the individual working steps, you will find an identification mark on the outside top right corner of the page in question.

Mechanical system

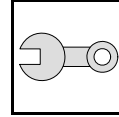

Electrical system

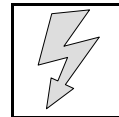

Water

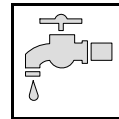

Fuel

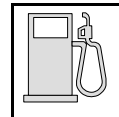

Exhaust gas

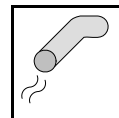

Combustion air

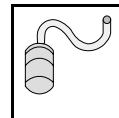

Special features are highlighted using the following symbols:



Specific risk of injury or fatal accidents.



Specific risk of damage to components.



Specific risk of fire or explosion.



Reference to general installation instructions of Webasto components or to the manufacturer's vehicle-specific documents.



Reference to a special technical feature.



The arrow in the vehicle icon indicates the position on the vehicle and the viewing angle.

All dimensions are in mm!

Tightening torque of hose clamps = 2.0 + 0.5 Nm!

Tightening torque of Ejoy screws, Ejoy studs = 10 Nm!

Preliminary Work

WARNING!

- Open fuel tank cap, ventilate tank.
- Close the tank cap again.
- Disconnect the battery "earth" or "ground" connection.
- Copy the factory number from the original type label to the duplicate type label.
- Remove years that do not apply from the duplicate label.
- Attach the duplicate label (type label) in the appropriate place.
- Remove the air filter together with the intake hose.
- Remove the expansion tank of the cooling system.
- Detach the bracket of the hydraulic oil reservoir.
- Remove the right-hand headlight
- Underride protection
- Remove the fuel tank
- Remove the fuel-tank sending unit in accordance with the manufacturers specifications.
- Remove the trim in the right footwell
- Remove the glove compartment.

Remove page 24 "Operating Instructions for End Customer" and add to the vehicle operating instructions.

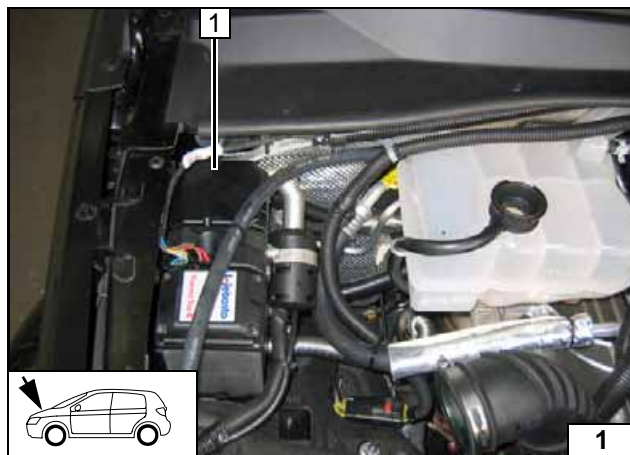

Heater unit installation location

- 1 Heater unit

Installation location



Electrical system

Digital timer

- 1 Digital timer

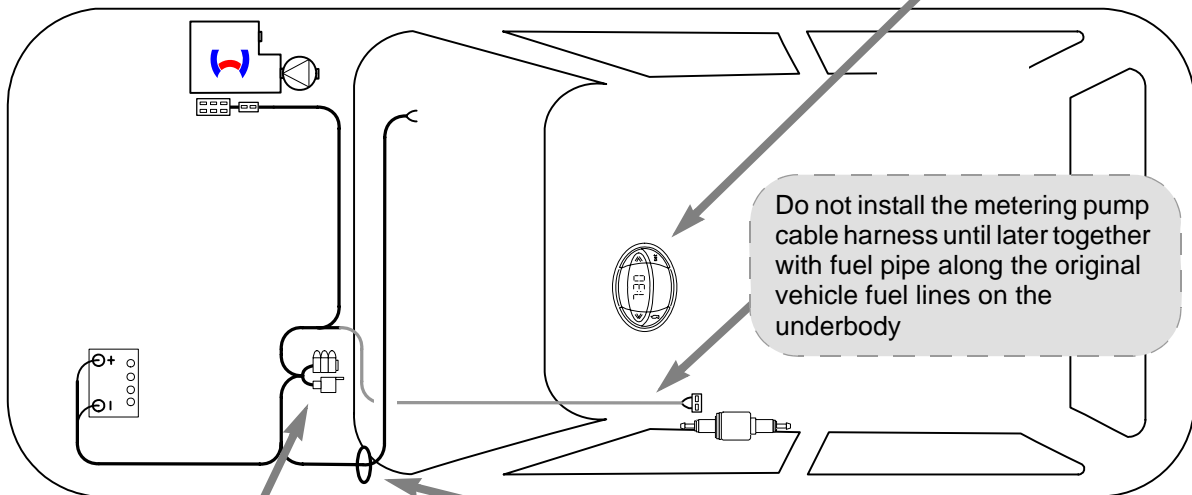
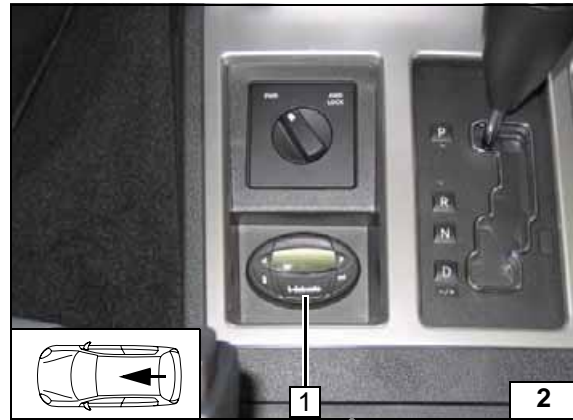

Wiring harness installation diagram

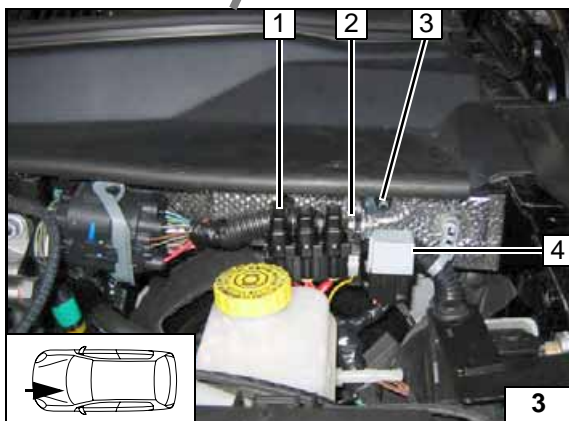

Fuse holder, relay K3

- 1 Fuse holder
- 2 Retaining plate of fuse holder, M5x16 bolt, washers, angle bracket, K3 relay 4, M5 flanged nut
- 3 Original vehicle nut

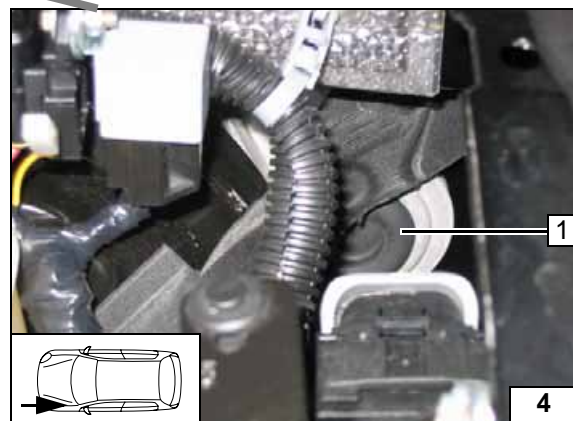

Wiring harness pass through

- 1 Protective rubber plug



Fan controller for manual air conditioning

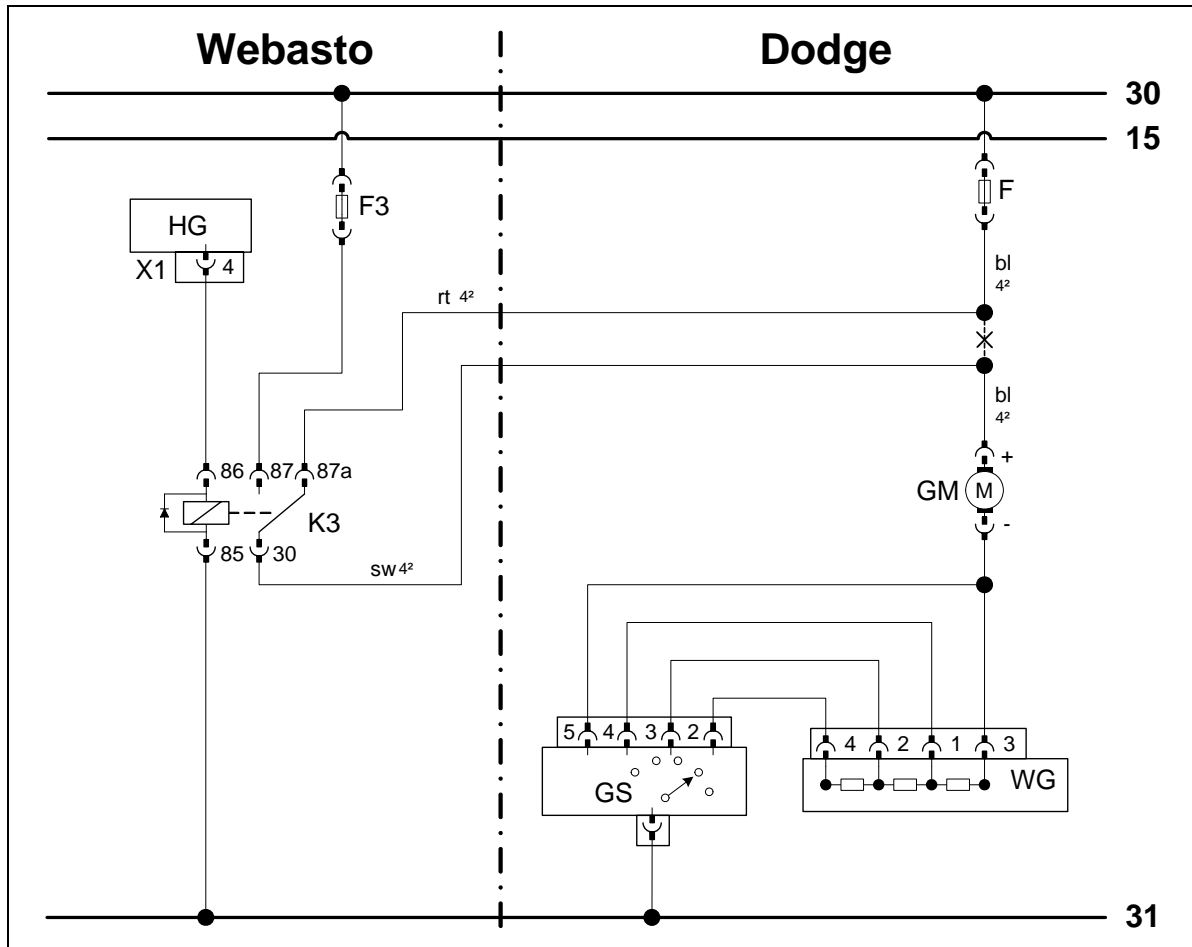

Wiring diagram

Webasto components		Vehicle components		Colors and symbols	
HG	Heater unit TT-C/E	GM	Fan motor	rt	red
X1	6-pin heater unit connector	GS	Fan switch	bl	blue
F3	25 A fuse	WG	Resistor group	sw	black
K3	Fan relay	F	Original vehicle fuse		Insulate wire ends and tie back
				X	Cutting point
				Wiring colors may vary.	

Legend

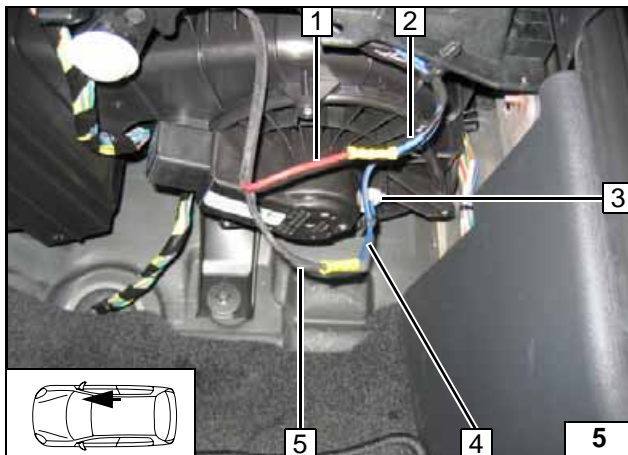

Connection to 2-pin connector 3 from the blower motor.
Produce connections as shown in wiring diagram.

- 1 Red (rt) wire from K3/87a
- 2 Blue (bl) wire of original vehicle fuse
- 4 Blue (bl) wire of fan motor
- 5 Black (sw) wire from K3/30



Connecting fan-motor

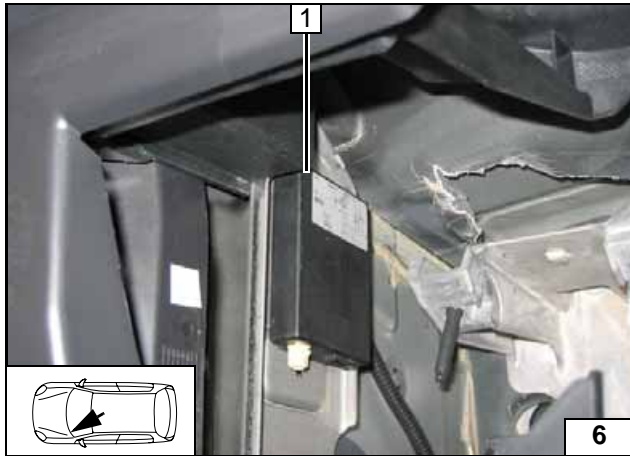

Remote option (Telestart)

1 Receiver with adhesive tape on body



Installing receiver

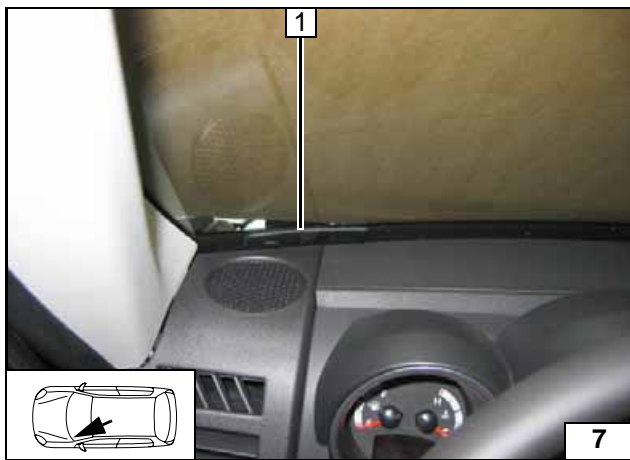

1 Antenna

Installing antenna

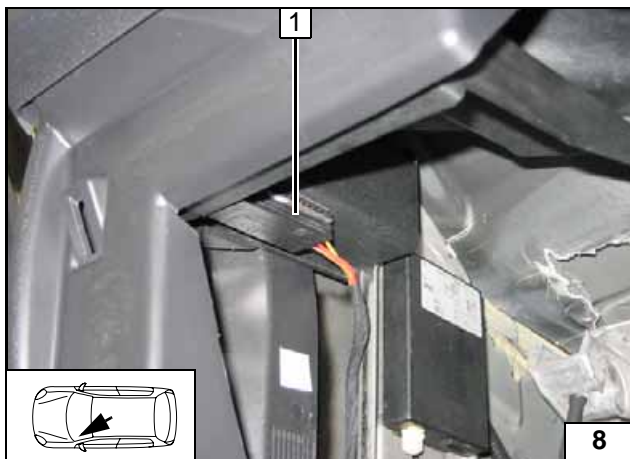

Temperature sensor for HTM100 only

1 Fasten temperature sensor with adhesive tape



Installing temperature sensor

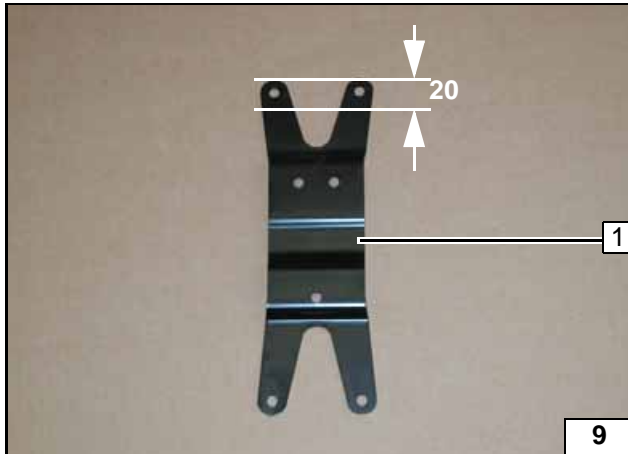
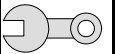

Preparing bracket

1 Bracket



Shortening bracket

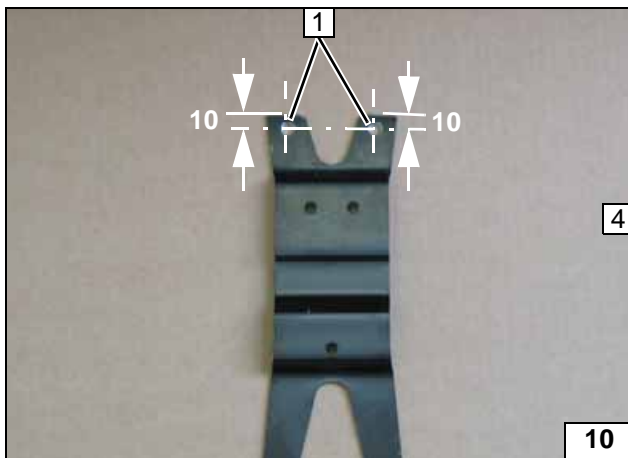

1 7 mm dia. hole [2x]

Drilling bracket

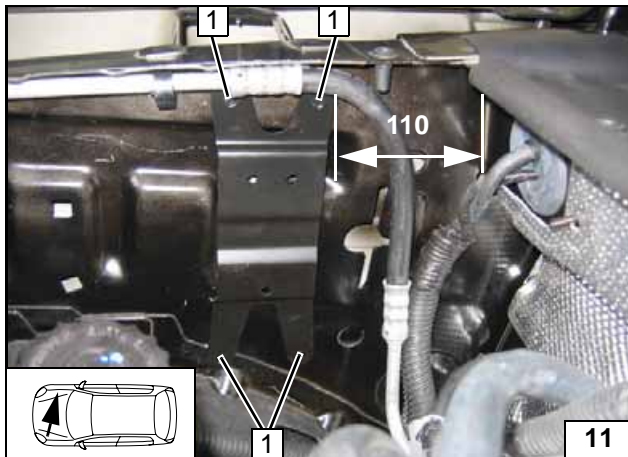

Preparing installation location

Lay on bracket and copy hole pattern 1 [4x].



Copying hole pattern

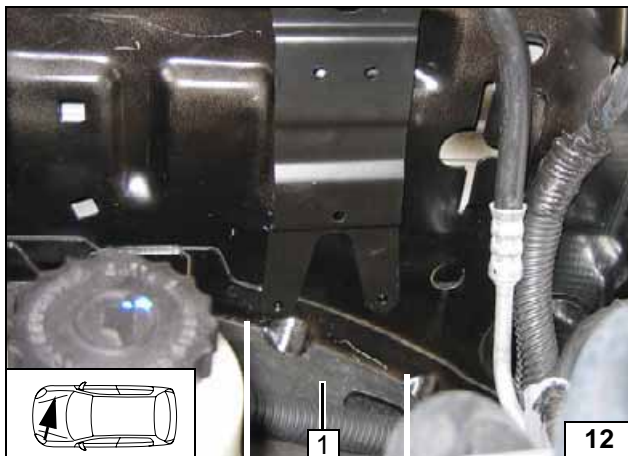

Cut out insulating mat 1 generously.



Removing insulating mat

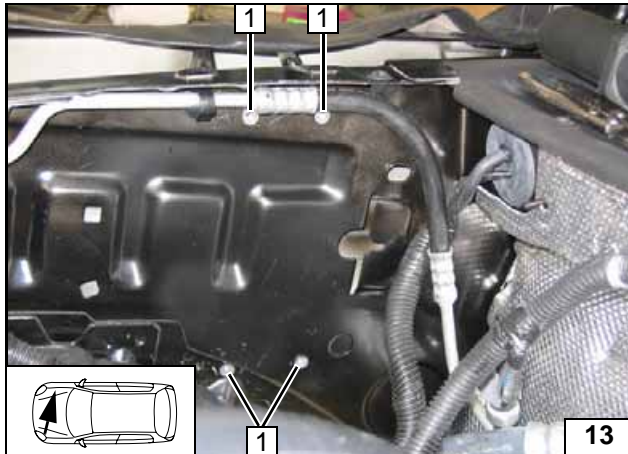
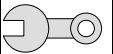

1 Drill 9.1 mm dia. hole; mount rivet nut [4x each]

Installing rivet nut

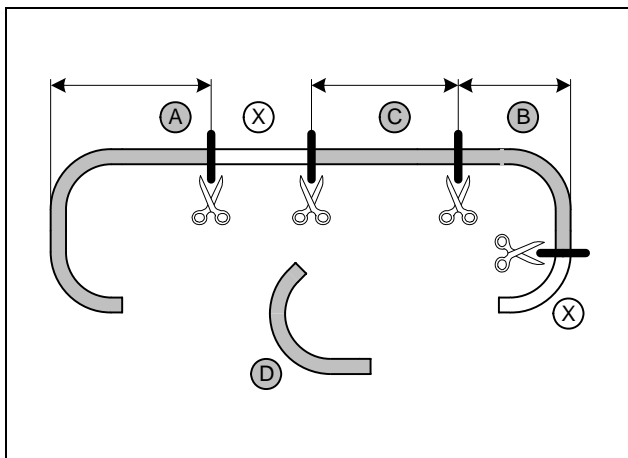

Preparing heater unit

a = 400
b = 130
c = 400

Discard section X

Cutting coolant hoses to length

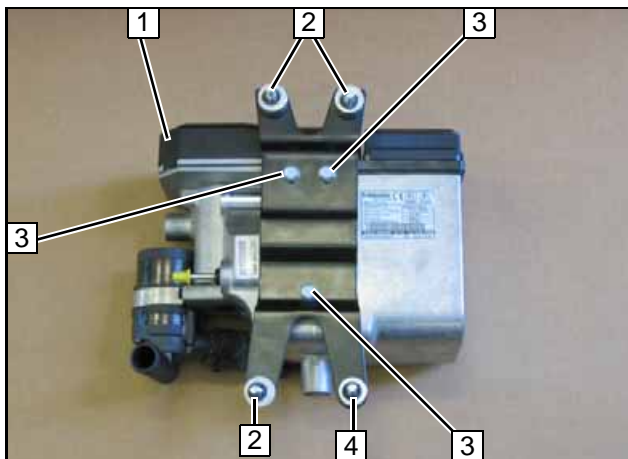

- 1 Heater unit
- 2 M6x30 bolt, spring lockwasher, 10 mm spacer, pin lock [3x each]
- 3 E-jot screw [3x]
- 4 M6x30 bolt, spring lockwasher, 8 mm spacer, pin lock

Installing bracket

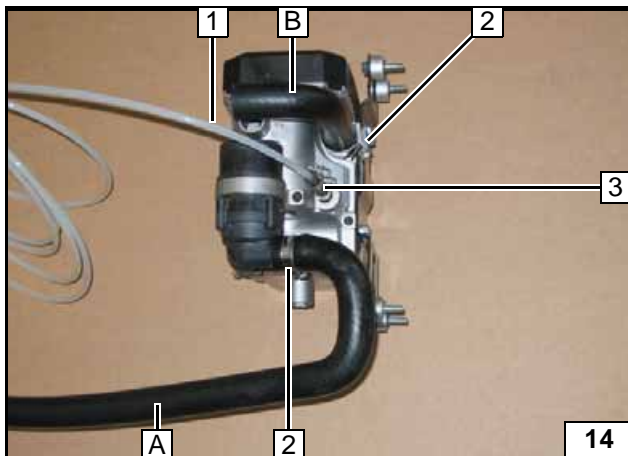

- 1 Fuel line
- 2 27 mm dia. clamp [2x]
- 3 Hose section, 10 mm dia. clamp [2x]

Premounting coolant and fuel

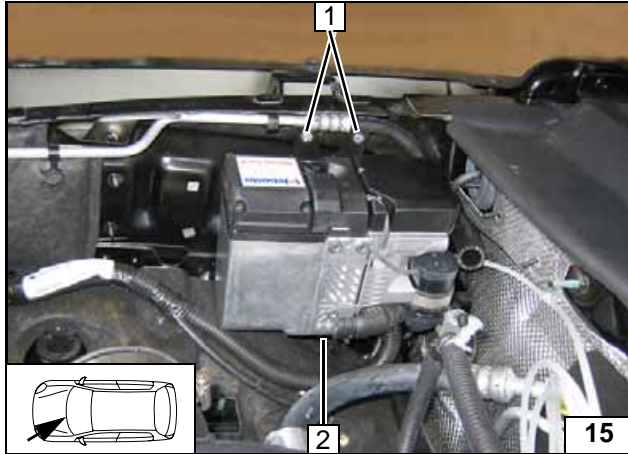
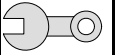

Installing heater unit

First position premounted heater unit with two lower bolts 2.

1 Upper fastening point



Installing heater unit



Coolant connection



WARNING!

Any coolant running off should be collected using an appropriate container. Install hoses so that they are kink-free. Unless specified otherwise, always fasten using cable ties. Position clamps so that no other hose can be damaged! When installing the coolant hose, the heater unit must be filled with coolant.

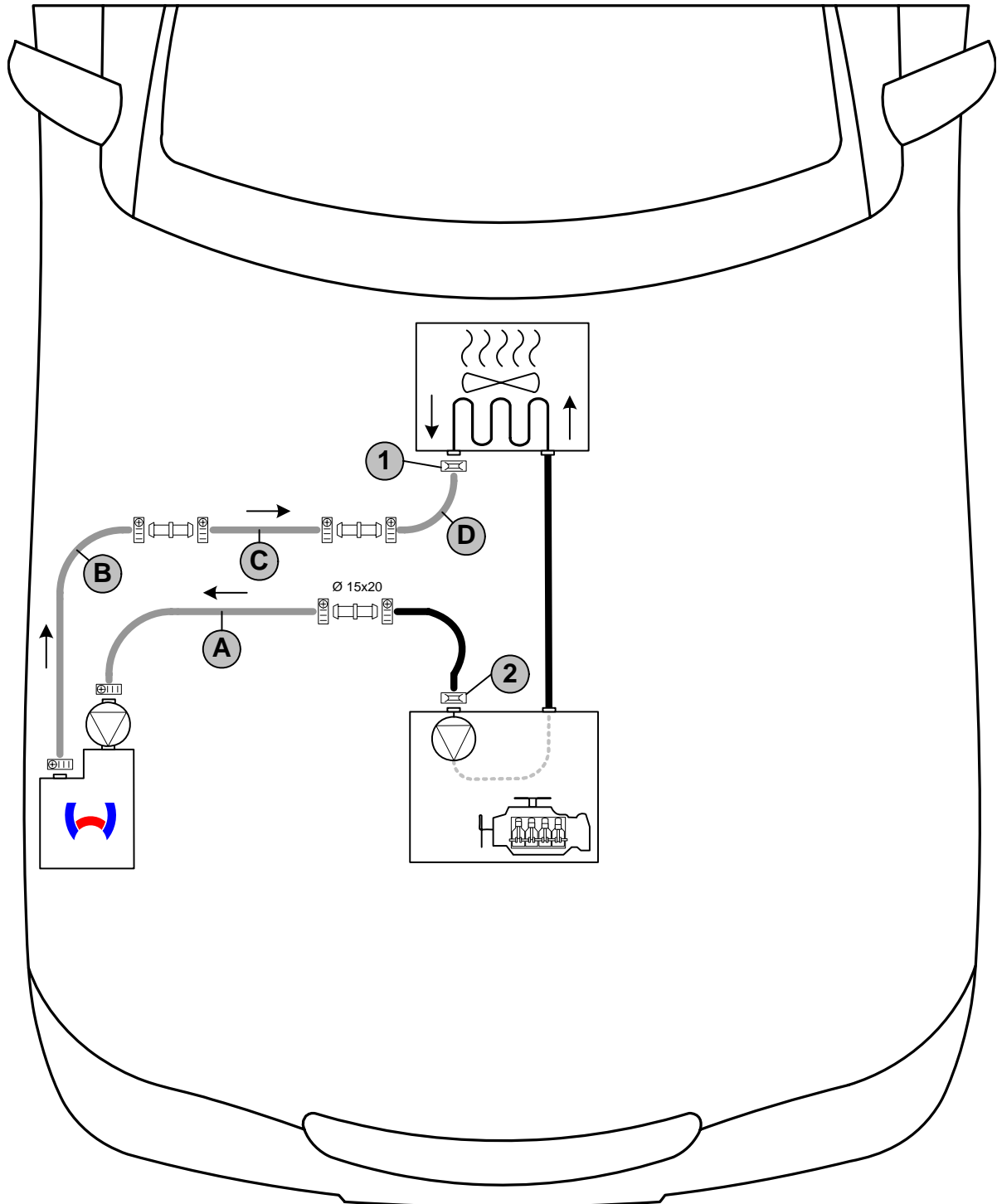
The connection should be "inline" based on the following diagram:



Coolant routing diagram

1 Spring clip  = 22 mm dia. 2 = Original vehicle spring clip. All connecting pipes without a specific designation  = dia. 20x20. All hose clamps without a specific designation  = 20-27 mm dia.



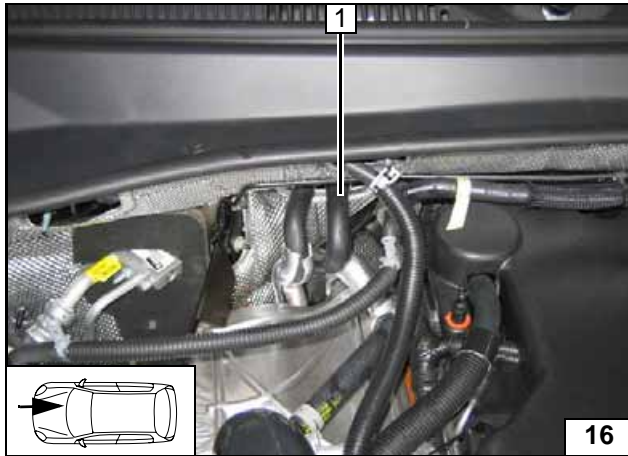
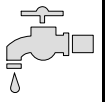

Remove heat shield and original vehicle hose **1**. This will be reused. Discard clamp on engine outlet.

Cutting point

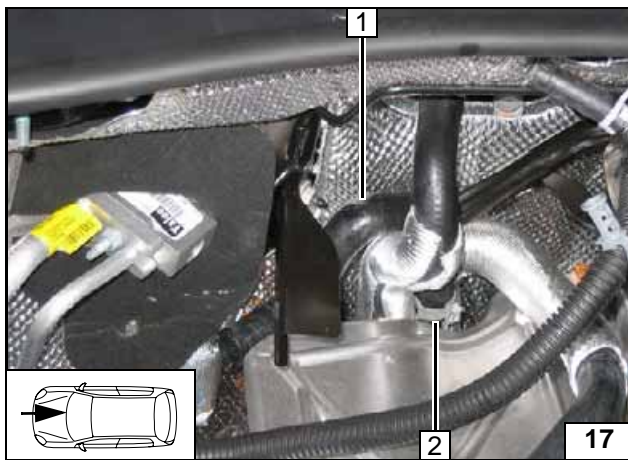

1 Original vehicle hose
2 Original vehicle clamp

Installing original vehicle hose

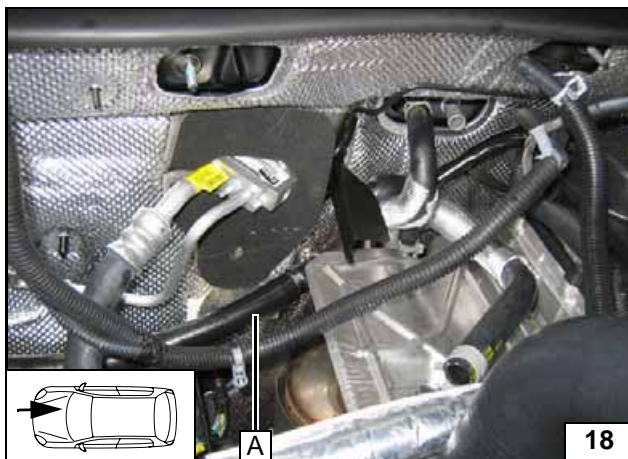

Connecting engine outlet

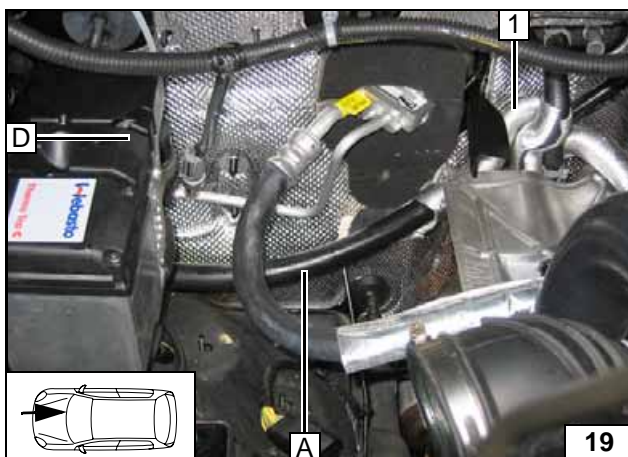

1 Mount original vehicle heat shield

Heat shield of hose A

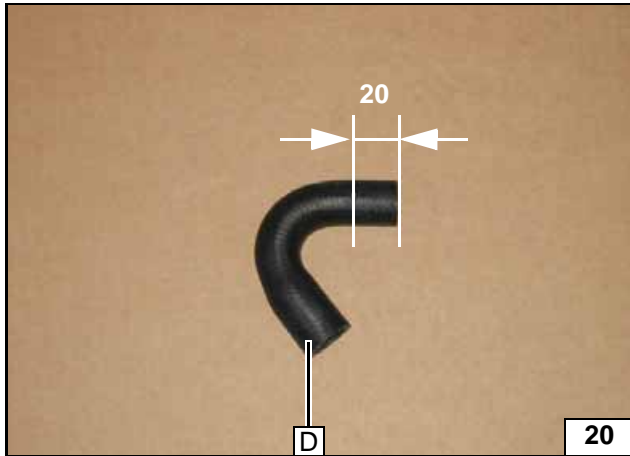

Shortening hose D

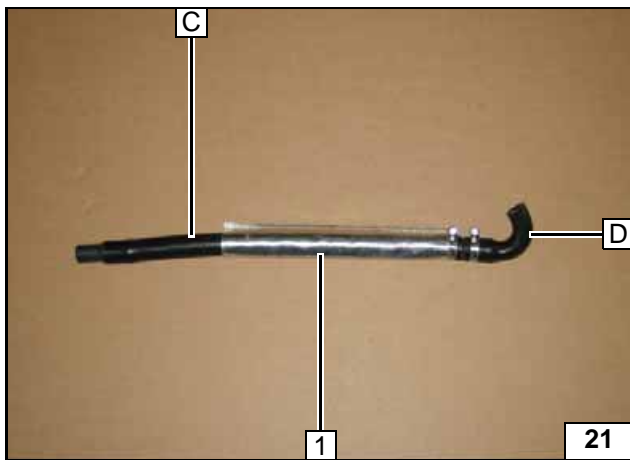

1 Heat shield

Premounting hose C and D

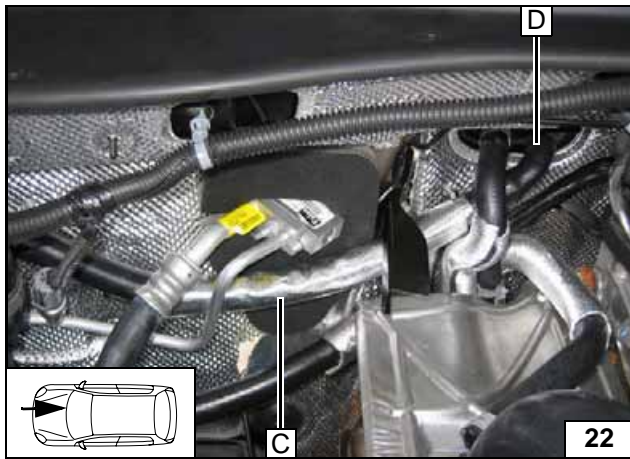

Connection on heat exchanger inlet

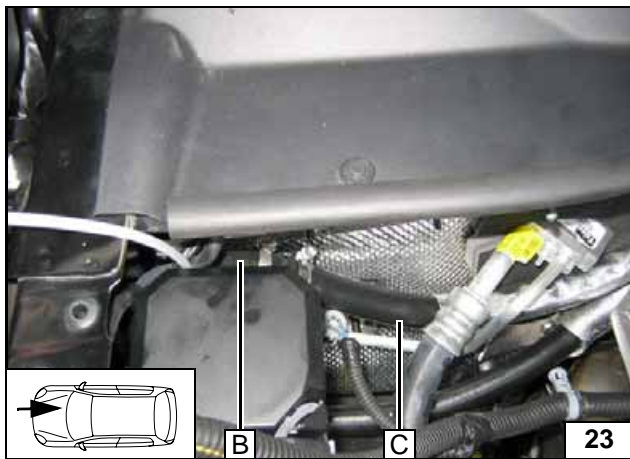

Connection to heater unit

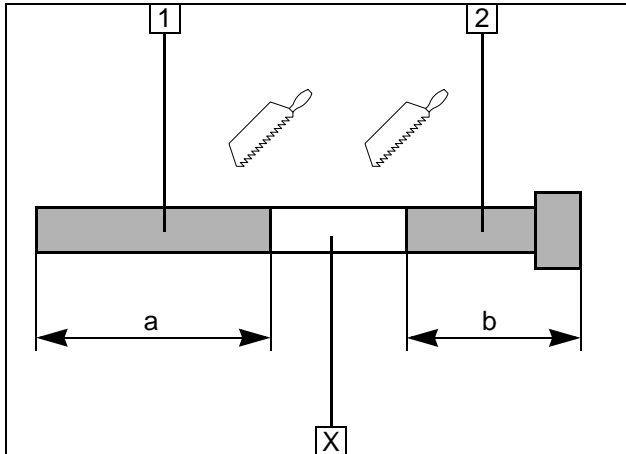
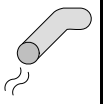

Exhaust gas

- 1 Exhaust pipe
a = 450
- 2 Exhaust end section
b = 450

Discard section X

Preparing exhaust pipe

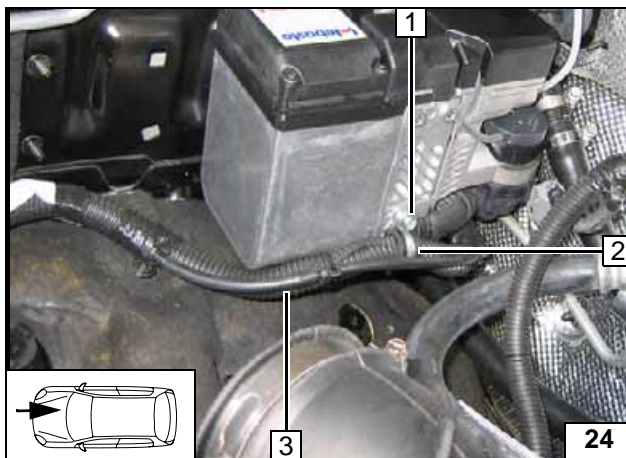

- 1 E-jot screw
- 2 18 mm dia. rubber-coated p-clamp
- 3 Original vehicle wiring harness

Fastening wiring harness

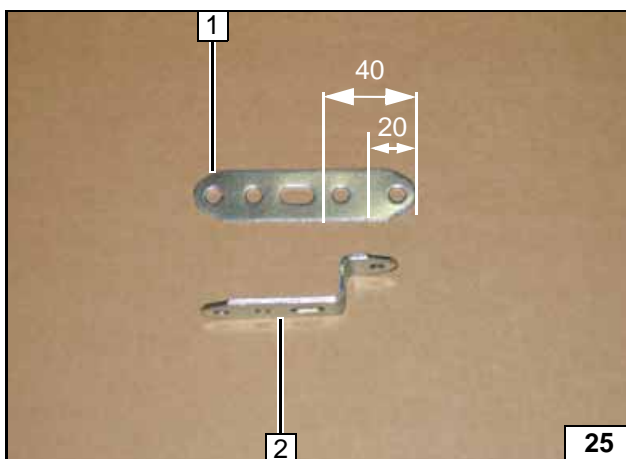

- 1 Perforated bracket prepared
- 2 Perforated bracket angled down

Angling down perforated bracket

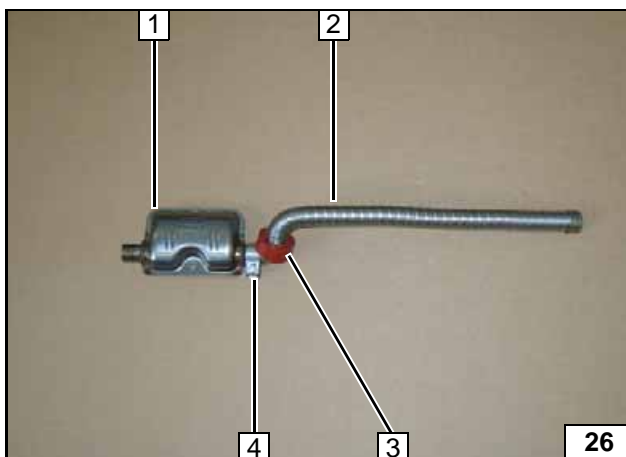

- 1 Muffler
- 2 Exhaust end section
- 3 Position red (rt) rubber profile
- 4 Hose clamp

Preassembling muffler

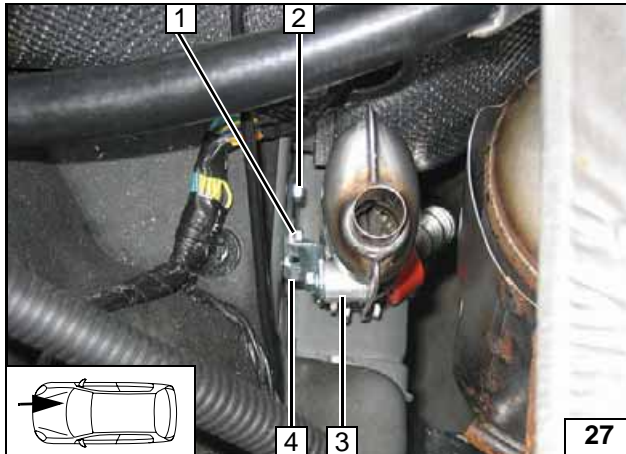
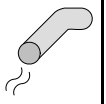

- 1 M6x20 bolt, spring lockwasher, large diameter washer, existing thread
- 2 M6x20 bolt, spring lockwasher, existing thread
- 3 M6x30 bolt, 20 mm spacer, M6 flanged nut
- 4 Perforated bracket

**Installing
muffler**

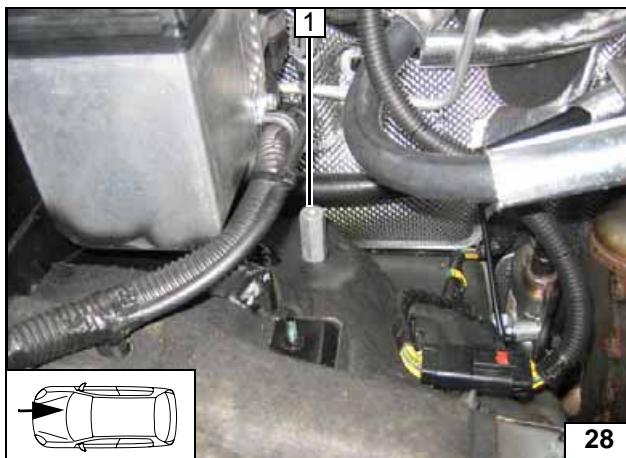

- 1 M6x40 spacer screw, existing stud bolt

**Installing
spacer nut**

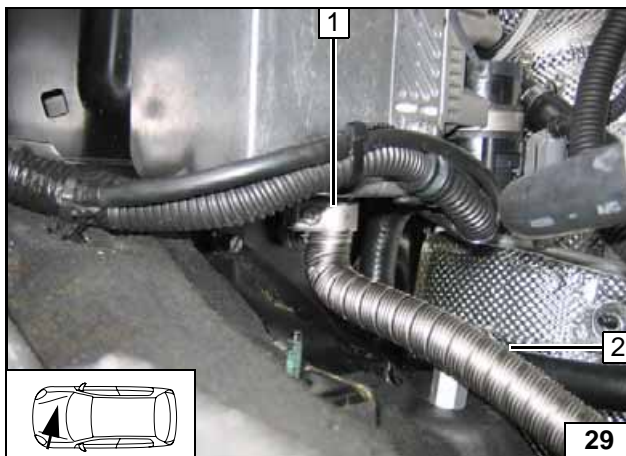

- 1 Hose clamp
- 2 Exhaust pipe

**Installing
exhaust
pipe**

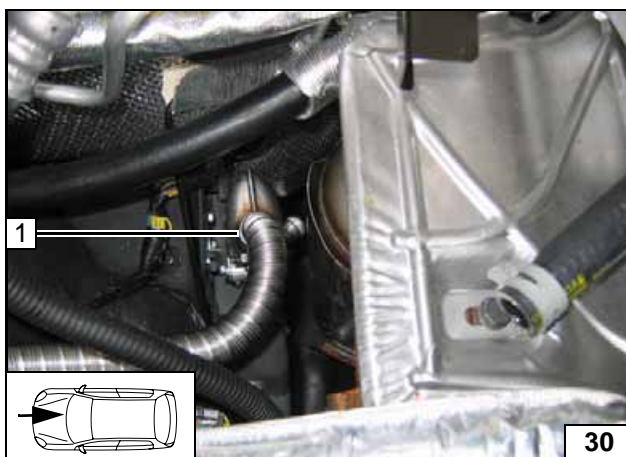

- 1 Hose clamp

**Installing
exhaust
pipe**

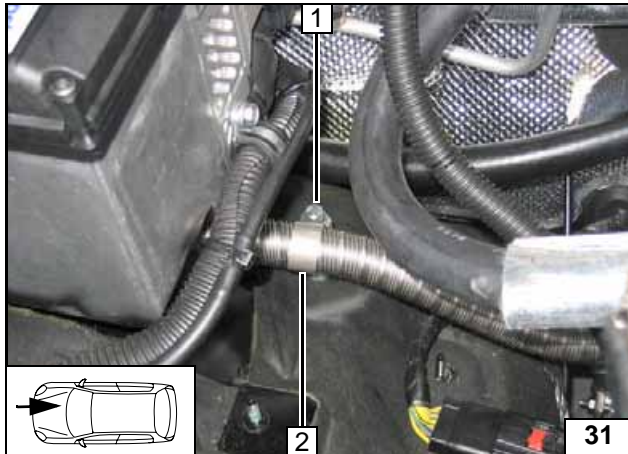
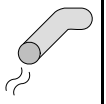

- 1 M6x20 bolt, spring lockwasher
- 2 P-clamp

**Fastening
exhaust
pipe**

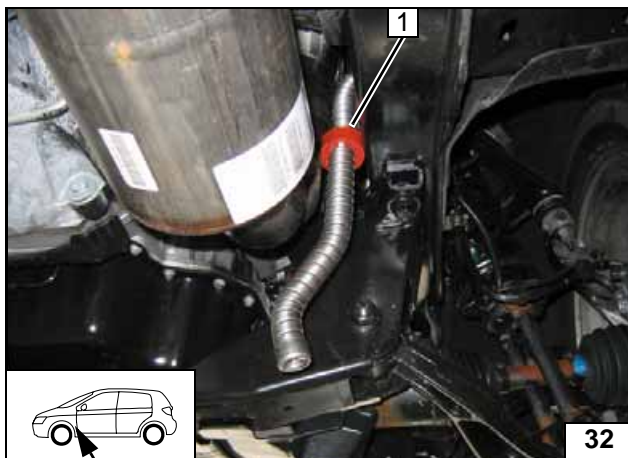

- 1 Push on red (rt) rubber isolator and position

**Installing
exhaust
end
section**

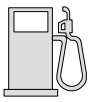

Fuel

CAUTION!

Open the vehicle's fuel tank cap, ventilate the tank and then re-close the tank lock.

Catch any fuel running off with an appropriate container.

Install fuel line and metering-pump wiring harness so that they are protected against stone impact. Unless specified otherwise, always fasten using cable ties. Mount the fuel line and wiring harness with rub protection on sharp edges.

WARNING!

The fuel line and wiring harness are routed to the metering pump in as shown in the wiring harness routing diagram.



Installing lines

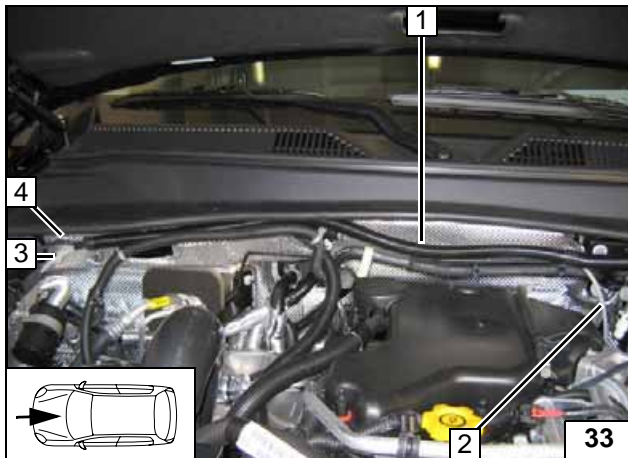

Cut open corrugated tube **1** and install fuel line **3** with wiring harness of heater unit **4**. Connect wiring harness of heater unit. Route corrugated tube on firewall to left-hand side of vehicle. Route fuel line **2** together with line of metering pump along original vehicle fuel lines to installation location of metering pump.

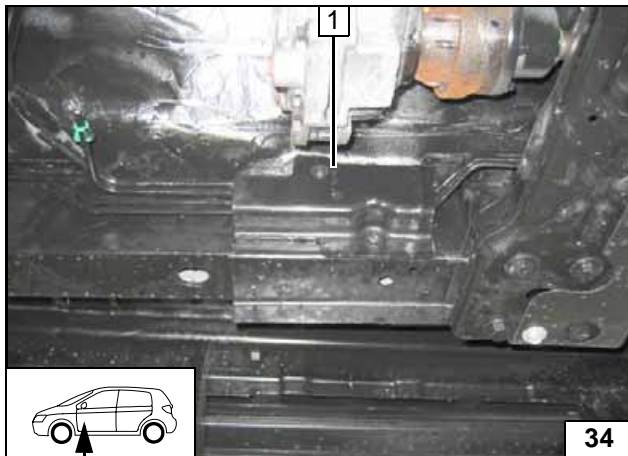

1 Remove cover



Installation location of metering pump

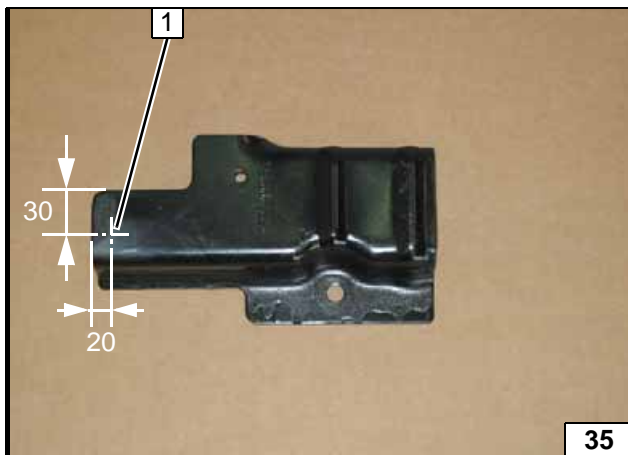

Drill 7 mm dia. hole **1** and remount cover.



Drilling cover

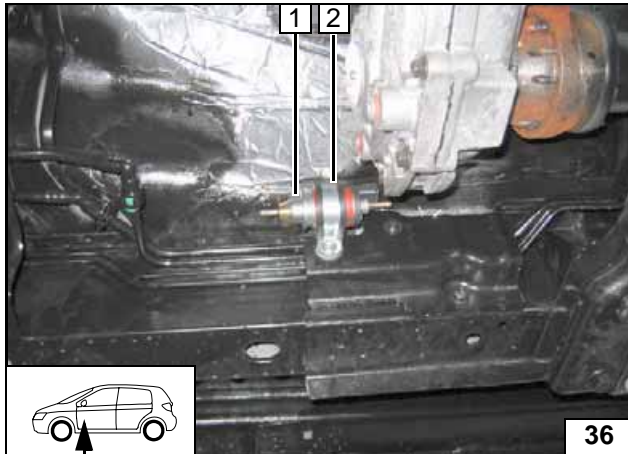
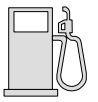

- 1 Metering pump
- 2 Rubber-coated p-clamp, silent block, flanged nut [2x]



Installing metering pump

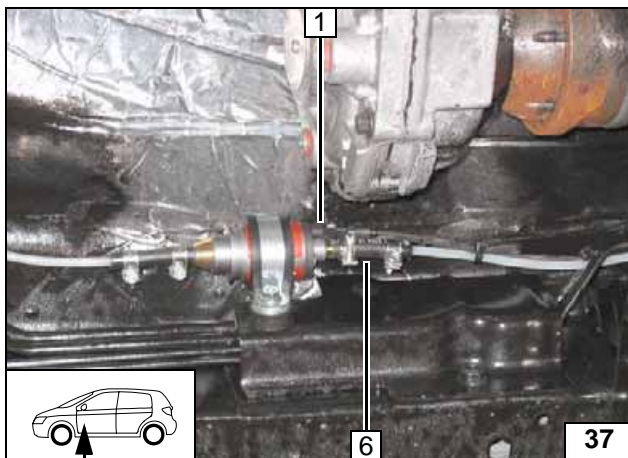

Check the position of the components; adjust if necessary. Check that they have free clearance.

- 1 Wiring harness of metering pump, connector mounted
- 2 Hose section, 10 mm dia. clamp [2x]



Connecting to metering pump

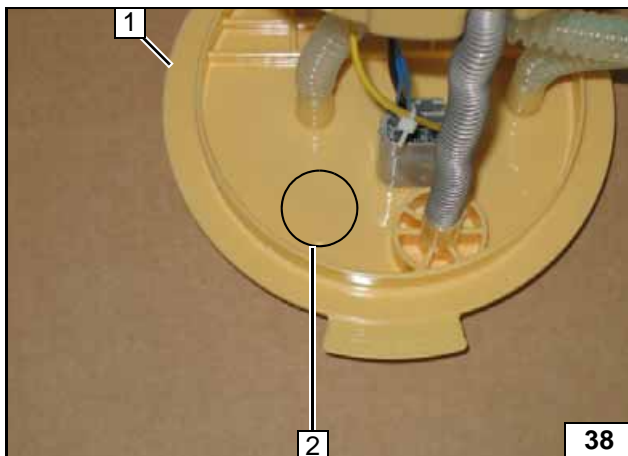

Remove fuel tank and fuel-tank sending unit 1 according to manufacturer's information. Fuel standpipe will be mounted within stamped area 2.



Removing fuel

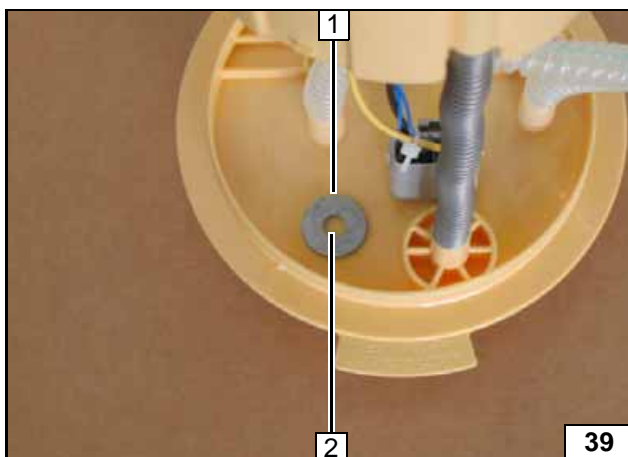

- 1 Position large diameter washer in center of stamped area
- 2 Copy hole pattern, 6 mm dia. hole



Removing fuel

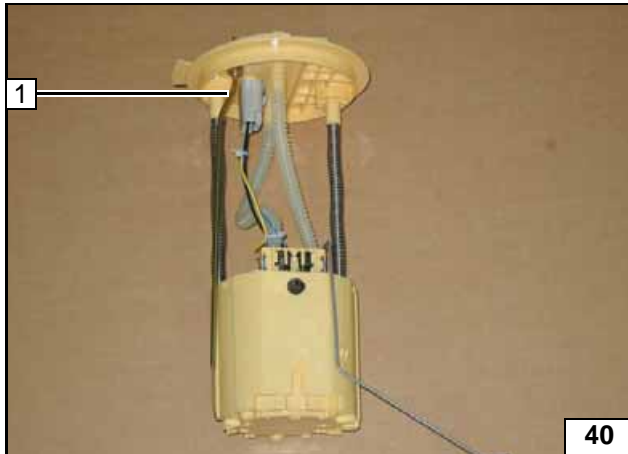

Shape fuel standpipe 1 according to template, cut to length and install.



Installing fuel standpipe

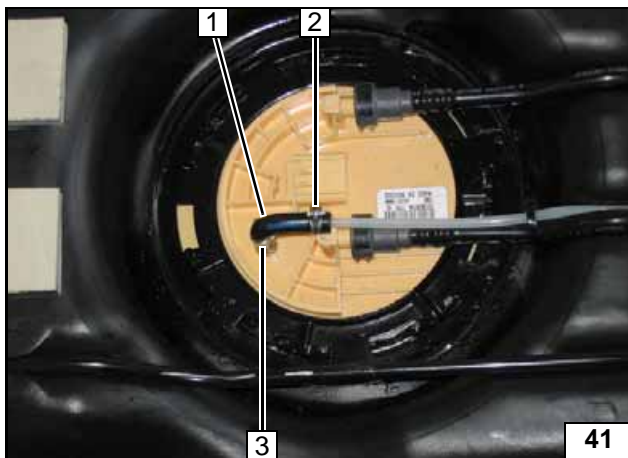

Install fuel-tank sending unit according to manufacturer's specifications.



Connecting fuel line

- 1 90° elbow
- 2 10 mm dia. clamp
- 3 8 mm dia. clamp

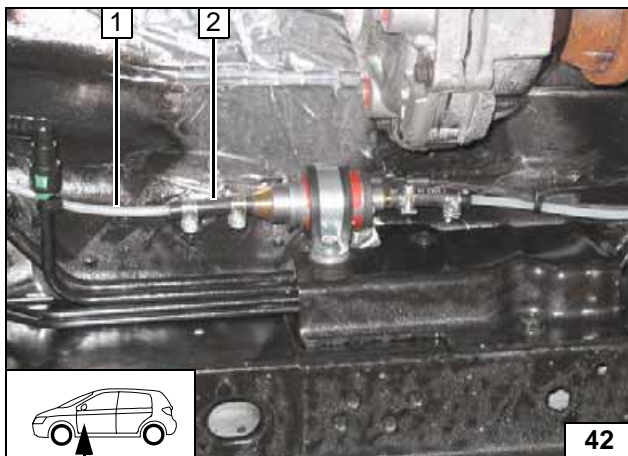

- 1 Fuel line
- 2 Hose section, 10 mm dia. clamp [2x]



Connecting to metering pump

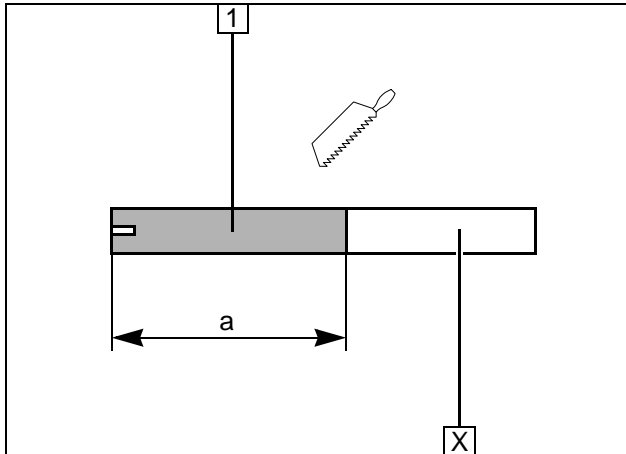
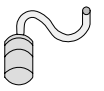

Combustion air

- 1 Combustion air pipe
a = 170

Discard section X

Cutting combustion air pipe to length

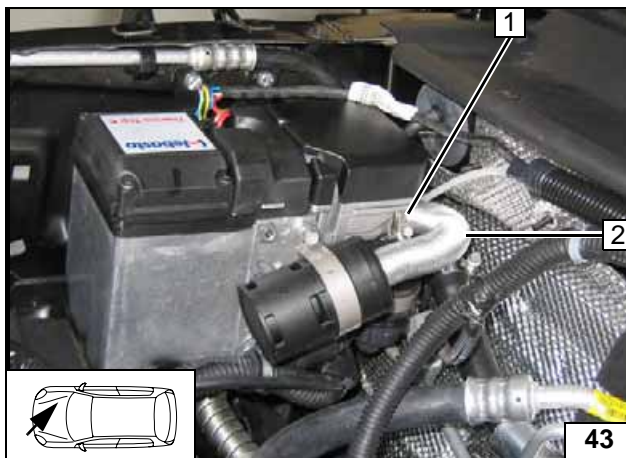

- 1 27 mm dia. clamp
- 2 Combustion-air intake pipe

Installing intake pipe

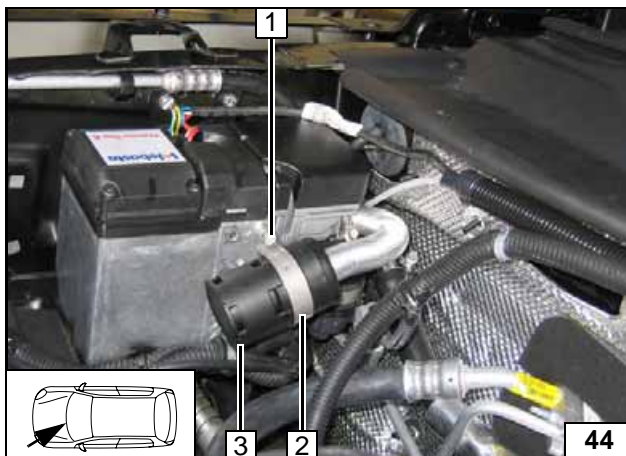

- 1 Eject screw
- 2 52 mm dia. clamp
- 3 Intake muffler



Installing muffler

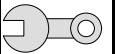

Final Work

WARNING!

Reassemble the disassembled components in reverse order.
 Check all hoses, clamps and all electrical connections for firm seating.
 Secure all loose cables using cable ties.
 Only use manufacturer-approved coolant.
 Spray the heater unit components with anti-corrosion wax (Tectyl 100K, Order No. 111329).

- Connect the battery
- Fill and bleed the coolant circuit according to the vehicle manufacturer's specifications.
- Set the digital timer.
- Make settings on A/C control panel according to the "Operating Instructions for End Customer".
- Check the proper operation of the additional heater, see the operating instructions/installation instructions.
- Attach the "Switch off additional heater before refueling" sticker to the left-hand B-pillar.



**Cutting out
underride
protection**

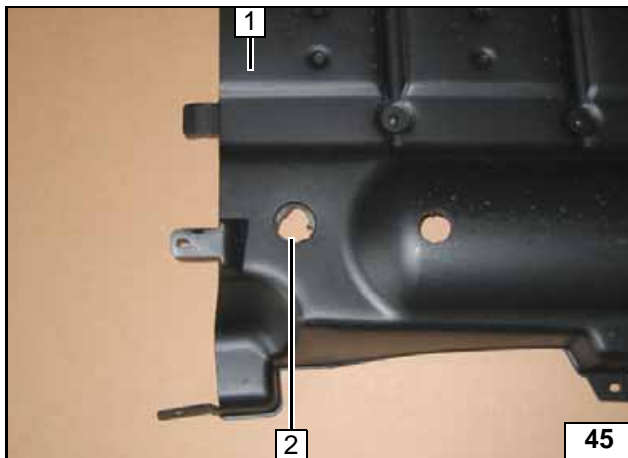

1 Underride protection
 2 42 mm dia. hole



Cut out insulation 1 in area of hole.



**Cutting out
insulation**

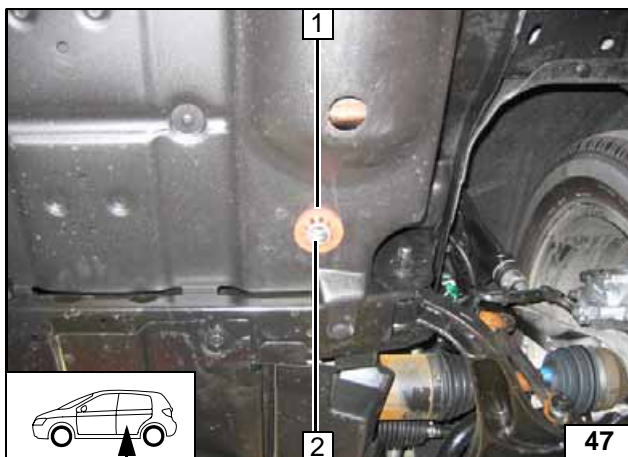

Align exhaust end section 2 flush on red rubber isolator 1.



**Mounting
rubber
isolator**

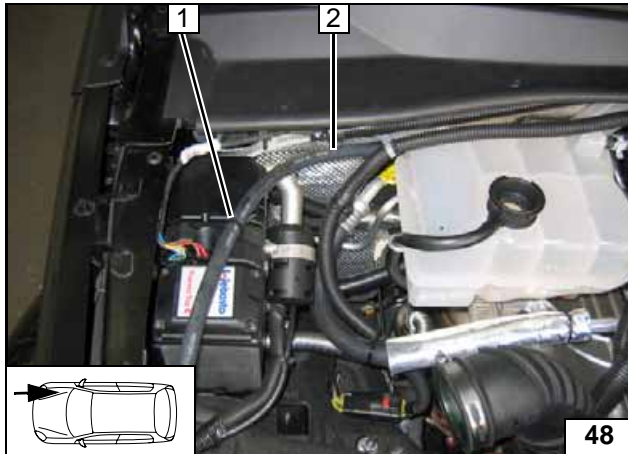
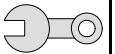

- 1 Punch through perforation, mount cable tie with clip
- 2 Coolant hose

Fastening coolant hose

Operating Instructions for End Customer



Please remove page and add to the vehicle operating instructions.

Note:

We recommend matching the heating time to the driving time.

Heating time = driving time

Example:

For a driving time of approx. 20 min. (in one direction), we recommend not exceeding a switch-on time of 20 min.

Before parking the vehicle, make the following settings:



- 2 Air outlet to windshield
- 1 Set fan to level "1", or possibly "2"
- 3 Set temperature to "max."

Manual air conditioning

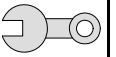

Template for Fuel Standpipe

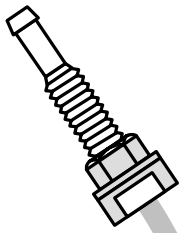

100 mm

0

100 mm



Scale 1:1

Compare the size of the printed version with dimension lines.
Permitted tolerance a maximum of 2%.

Set the printer settings to "no margin" or "minimize margins" and 100% of the normal size.