

# Water Heater

## Thermo Top Evo Parking Heater



## Installation Documentation Citroen C4 / DS4

### Validity

Manufacturer	Model	Type	EG-BE No. / ABE
Citroen	C4	NC	e2 * 2007 / 46 * 0040 * ...
Citroen	DS4	NX	e2 * 2007 / 46 * 0040 * ...

### C4

Motorisation	Fuel	Transmission type	Output in kW	Displacement in cm <sup>3</sup>	Engine code
1.4 VTi 95	Petrol	SG	70	1397	8FP
1.6 VTi 120	Petrol	SG	88	1598	5FS
1.6 VTi 120 AT	Petrol	AG	88	1598	5FS
1.6 THP 155	Petrol	EGS6	115	1598	5FV / 5FR

### DS4

Motorisation	Fuel	Transmission type	Output in kW	Displacement in cm <sup>3</sup>	Engine code
1.6 VTi 120	Petrol	SG	88	1598	5FS
1.6 THP 155	Petrol	SG	115	1598	5FV / 5FR

SG = Manual transmission

AG = Automatic transmission

EGS6 = Electronically controlled 6-gear transmission

### From Model Year 2011

#### Left-hand drive vehicle

**Verified equipment variants:** Manual / automatic air-conditioning system

Front fog lights

Headlight washer system

**Not verified:** Passenger compartment monitoring

**Total installation time:** approx. 9 hours

# Citroen C4 / DS4

## Table of Contents

Validity	1	Preparing Installation Location	17
Necessary Components	2	Preparing Heater	18
Installation Overview	2	Installing Heater	20
Information on Total Installation Time	2	Combustion Air	21
Information on Operating and Installation Instructions	3	Coolant Circuit	22
Information on Validity	4	Fuel	25
Technical Information	4	Exhaust Gas	29
Explanatory Notes on Document	4	Final Work	31
Preliminary Work	5	Template for Fuel Standpipe	32
Heater Installation Location	5	Operating Instructions for Manual Air-Conditioning	33
Preparing Electrical System	6	Operating Instructions Automatic Air-Conditioning	34
Electrical System	8		
Fan Controller for Manual Air-Conditioning	9		
Fan Controller for Automatic Air-Conditioning	12		
Digital Timer	16		
Remote Option (Telestart)	16		

## Necessary Components

- Basic delivery scope of *Thermo Top Evo* based on price list
- Installation kit for Citroen C4 / DS4 2011 Petrol: **1318759B**
- Heater control in accordance with price list and upon consultation with end customer
- In case of Telestart, indicator lamp in accordance with price list and in consultation with end customer

## Installation instructions:

- Arrange for the vehicle to be delivered with the tank only about ¼ full!
- The installation location of the push button in the case of Telestart or Thermo Call should be confirmed with the end customer.
- When installing a parking heater, we recommend the use of a larger battery for the vehicle.

## Installation Overview

### Legend:

1. Heater
2. Engine compartment fuse holder
3. Passenger compartment relay and fuse holder
4. IPCU
5. K2 relay (only with automatic A/C)
6. Circulating pump
7. Digital Timer
8. Metering pump

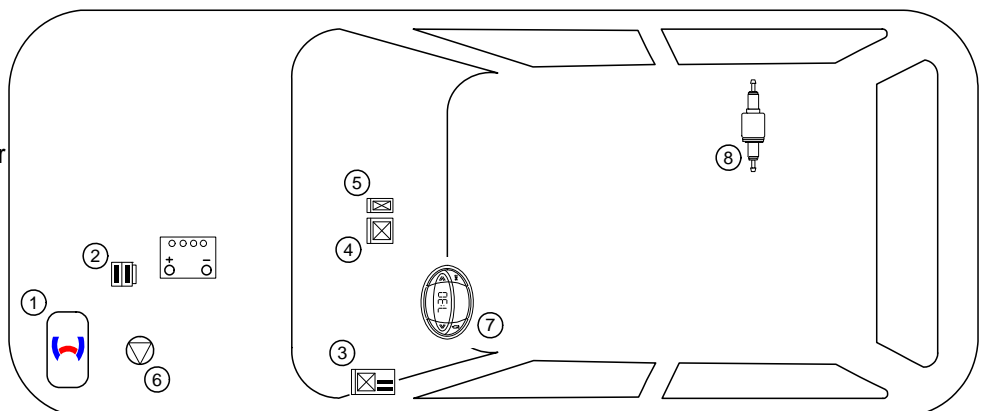

## Information on Total Installation Time

The total installation time includes the time needed for mounting and demounting of the vehicle-specific components, the heater specific installation time and all other times required for the system integration and initial start-up of the heater.

The total installation time may vary for vehicle equipment other than provided.

## Information on Operating and Installation Instructions

### 1 Important notes (not complete)

#### 1.1 Installation and repair



The improper installation or repairing of Webasto heating and cooling systems can cause fire or the leakage of deadly carbon monoxide, leading to serious injury or death.



To install and repair Webasto heating and cooling systems you need to have completed a special company training course and have the appropriate technical documentation, special tools and special equipment.



Installation and repair may ONLY be carried out by persons trained and certified in a Webasto training course. NEVER try to install or repair Webasto heating or cooling systems if you have not completed a Webasto training course, you do not have the necessary technical skills and you do not have the technical documentation, tools and equipment available to ensure that you can complete the installation and repair work properly.

Only use genuine Webasto parts. See the Webasto air and water heaters accessories catalogue for this purpose.

#### 1.2 Operation

To ensure safe operation, we recommend having the heater checked every two years by an authorised Webasto dealer, especially when used over a long period and/or under extreme environmental conditions.

Do not operate the heater in closed rooms due to the danger of poisoning and suffocation.

Always switch off the heater before refuelling.

The heater may only be used with the prescribed fuel Diesel (DIN EN 590) or petrol (DIN EN 227).

The heater may not be cleaned with a high-pressure cleaner.

#### 1.3 Please note

ALWAYS follow all Webasto installation and operating instructions and observe all warnings.

To become familiar with and understand all functions and properties of the heater, the operating instructions must be read carefully and observed at all times.

For proper, safe installation and repair work, the installation instructions with all warnings and safety information must be carefully read and observed at all times. Please always contact a workshop authorised by Webasto for all installation and repair work.

#### Important

**Webasto shall assume no liability for defects, damage and injuries resulting from a failure to observe the installation, repair and operating instructions of the information contained in them.**

**This liability exclusion particularly applies to improper installations and repairs, installations and repairs by untrained persons or in the case of a failure to use genuine spare parts.**

**The liability due to culpable disregard to life, limb or health and due to damage or injuries caused by a wilful or reckless breach of duty remain unaffected, as does the obligatory product liability.**

**Installation should be carried out according to the general, standard rules of technology. Unless specified otherwise, fasten hoses, wires and wiring harnesses to original vehicle lines and wiring harnesses using cable ties. Insulate loose wires and tie back. Connectors on electronic components have to audibly click into place during installation.**

**Sharp edges should be fitted with rub protection. Spray unfinished body areas, e.g. drilled holes, with anti-corrosion wax (Tectyl 100K, Order No. 111329).**

**Observe the instructions and guidelines of the respective vehicle manufacturer for demounting and mounting vehicle specific components!**

**The initial startup is to be executed with the Webasto Thermo Test Diagnosis.**

**When installing an IPCU, the corresponding settings must be checked or adjusted before the installation.**

### 2 Statutory regulations governing installation

Guidelines	Thermo Top Evo
Heating Directive ECE R122	E1 00 0258
EMC Directive ECE R10	E1 03 5627

#### Note

The regulations of these guidelines are binding in the scope of the Directive 70/156/EEC and/or 2007/46/EC (for new vehicle models from 29/04/2009) and should also be observed in countries in which there are no special regulations.

#### Important

Failure to follow the installation instructions will result in the invalidation of the type approval for the heater and therefore invalidation of the general **homologation of the vehicle**.

#### Note

For vehicles with an EU permit, no entry in accordance with § 19 Sub-Section 4 of Annex VIII b to the Road Traffic Act is required.

### 2.1 Excerpt from the directive 2001/56/EC Appendix VII for the installation of the heater

Beginning of excerpt.

#### ANNEX VII

#### REQUIREMENTS FOR COMBUSTION HEATERS AND THEIR INSTALLATION

##### 1. GENERAL REQUIREMENTS

1.7.1. A clearly visible tell-tale in the operator's field of view shall inform when the combustion heater is switched on or off.

##### 2. VEHICLE INSTALLATION REQUIREMENTS

###### 2.1. Scope

2.1.1. Subject to paragraph 2.1.2. combustion heaters shall be installed according to the requirements of this Annex.

2.1.2. Vehicles of category O having liquid fuel heaters are deemed to comply with the requirements of this Annex.

###### 2.2. Positioning of heater

2.2.1. Body sections and any other components in the vicinity of the heater must be protected from excessive heat and the possibility of fuel or oil contamination.

2.2.2. The combustion heater shall not constitute a risk of fire, even in the case of overheating. This requirement shall be deemed to be fulfilled if the installation ensures an adequate distance to all parts and suitable ventilation, by the use of fire resistant materials or by the use of heat shields.

2.2.3. In the case of M2 and M3 vehicles, the heater must not be positioned in the passenger compartment. However, an installation in an effectively sealed envelope which also complies with the conditions in paragraph 2.2.2 may be used.

2.2.4. The label referred to in paragraph 1.4 or a duplicate, must be positioned so that it can be easily read when the heater is installed in the vehicle.

2.2.5. Every reasonable precaution should be taken in positioning the heater to minimise the risk of injury and damage to personal property.

###### 2.3. Fuel supply

2.3.1. The fuel filler must not be situated in the passenger compartment and must be provided with an effective cap to prevent fuel spillage

2.3.2. In the case of liquid fuel heaters, where a supply separate to that of the vehicle is provided, the type of fuel and its filler point must be clearly labelled

2.3.3. A notice, indicating that the heater must be shut down before refuelling, must be affixed to the fuelling point. In addition a suitable instruction must be included in the manufacturer's operating manual.

###### 2.4. Exhaust system

2.4.1. The exhaust outlet must be located so as to prevent emissions from entering the vehicle through ventilators, heated air inlets or opening windows.

###### 2.5. Combustion air inlet

2.5.1. The air for the combustion chamber of the heater must not be drawn from the passenger compartment of the vehicle.

2.5.2. The air inlet must be so positioned or guarded that blocking by rubbish or luggage is unlikely.

###### 2.6. Heating air inlet

2.6.1. The heating air supply may be fresh or recirculated air and must be drawn from a clean area not likely to be contaminated by exhaust fumes emitted either by the propulsion engine, the combustion heater or any other vehicle source.

2.6.2. The inlet duct must be protected by mesh or other suitable means.

###### 2.7. Heating air outlet

2.7.1. Any ducting used to route the hot air through the vehicle must be so positioned or protected that no injury or damage could be caused if it were to be touched.

2.7.2. The air outlet must be so positioned or guarded that blocking by rubbish or luggage is unlikely.

End of excerpt.

In multilingual versions the German language is binding.

## Information on Validity

This installation documentation applies to Citroen C4 / DS4 Petrol vehicles - for validity, see page 1 - from model year 2011 and later, assuming technical modifications to the vehicle do not affect installation, any liability claims excluded. Depending on the vehicle version and equipment, modifications may be necessary during installation with respect to these "installation instructions".

Vehicle and engine types, equipment variants and other specifications not listed in this installation documentation have not been tested. However, installation according to this installation documentation may be possible.

## Technical Information

### Special Tools

- Hose clamp pliers for auto-tightening hose clamps
- Hose clamp pliers for Clic hose clamps of type W
- Automatic wire stripper 0.2 - 6mm<sup>2</sup>
- Crimping pliers for cable lug / tab connector 0.5 - 6mm<sup>2</sup>
- Torque wrench for 2.0 - 10 Nm
- Hose clamping pliers
- Metric thread-setter kit
- Webasto Thermo Test Diagnosis with current software

### Dimensions

- All dimensions in mm.

### Tightening torque values

- Tightening torque values of 5x13 heater bolts = 8Nm.
- Tightening torque values of 5x15 retaining plate of water connection piece bolts = 7Nm.
- Tighten other bolt connections in accordance with manufacturer's instructions or in accordance with state-of-the-art-technology.

## Explanatory Notes on Document

You will find an identification mark on the outside top right corner of the page in question to provide you with a quick overview of the individual working steps.

Special features are highlighted using the following symbols:

### Mechanical system



### Electrical System



### Coolant Circuit

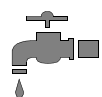

### Combustion Air

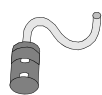

### Fuel



### Exhaust gas



### Software



Special risk of injury or fatal accidents.



Specific risk of damage to components.



Specific risk of fire or explosion.



Reference to general installation instructions of the Webasto component or to vehicle specific documents of the manufacturer



Reference to a special technical feature.



The arrow in the vehicle icon indicates the position on the vehicle and the viewing angle.

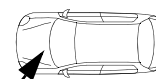
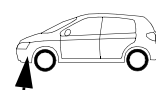

# Citroen C4 / DS4

## Preliminary Work

### Vehicle

- Open the fuel tank cap.
- Ventilate the fuel tank.
- Close the fuel tank cap again.
- Depressurise the cooling system.
- Disconnect and completely remove the battery with carrier.
- Remove the air filter together with the intake hose.
- Remove the bracket of the air filter (original vehicle bolts will be reused).
- Remove the coolant reservoir cap.
- Remove the instrument panel at the centre of the storage compartment.
- Remove the trim of the A/C control panel.
- Remove the A/C control panel in accordance with the manufacturer's instructions.
- Remove the radio with shaft.
- Remove the lower and left instrument panel trim on the driver's side.
- Remove the knee air bag.
- Open the right-hand tank-fitting service lid.
- Remove the fuel-tank sending unit in accordance with the manufacturer's instructions.
- Remove the underride protection.

### Heater

- Remove years that do not apply from the type and duplicate label.
- Attach the duplicate label (type label) in the appropriate place in the engine compartment.

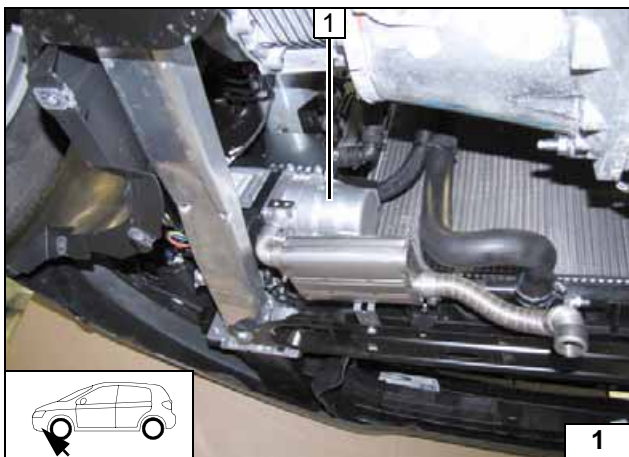

### Heater Installation Location

1 Heater

Installation  
location

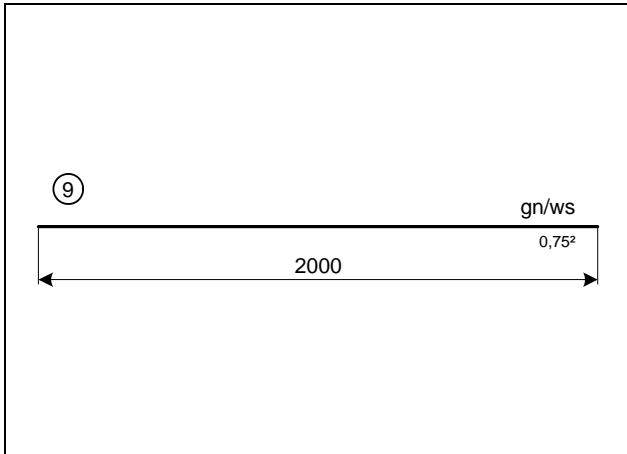

### Preparing Electrical System

Wire sections retain their numbering throughout the entire document.



#### Cutting wires to length

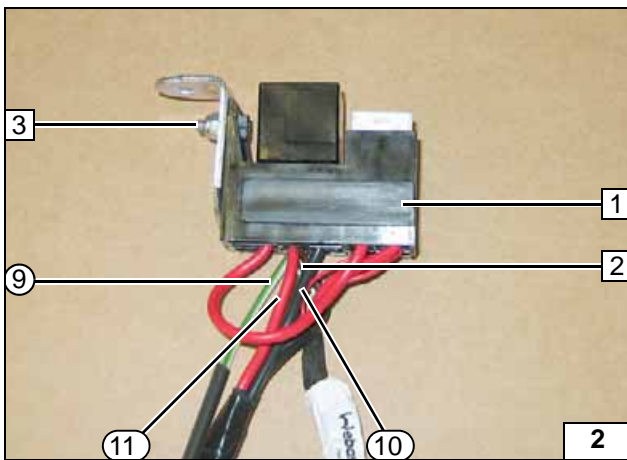

Detach and remove contact of K1/86. Install wires as shown in following wiring diagram with contacts supplied.



- 1 Relay and fuse holder of passenger compartment
- 2 Green/white (gn/ws) wire of K1/86
- 3 M5x16 bolt, angle bracket, large diameter washer [2x], nut
- 9 Green/white (gn/ws) wire of K1/86
- 10 Black (sw) wire from K1/30
- 11 Red (rt) wire of K1/87a

#### Preparing passenger compartment relay and fuse holder

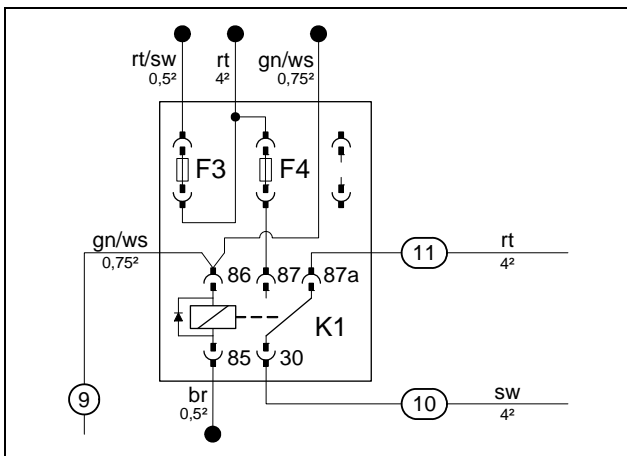

Insert 25A fuse F4 and K1 relay. Pull wire 9 into the protective sleeving provided.



#### Inserting F4 and preparing K1 relay

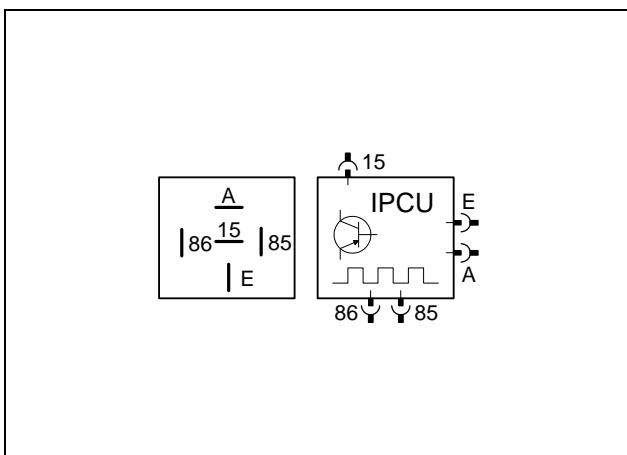

IPCU view on contact side.



Check the IPCU settings before start-up of the heater and adjust if necessary.

Settings:

- Duty cycle: 70%
- Frequency: 400Hz
- Voltage: 12V
- Function: Low-side

#### Preparing IPCU

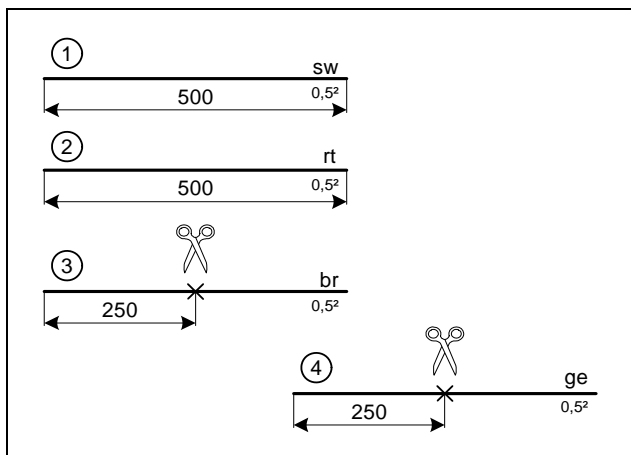

**Manual air-conditioning**



**Cutting wires to length**

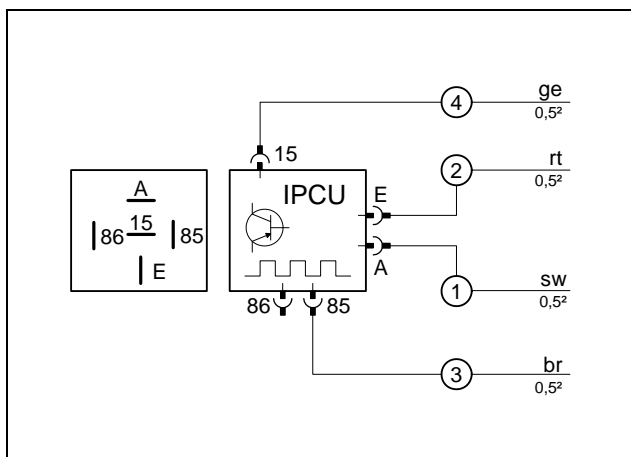

Connect lines to IPCU socket.  
IPCU view on contact side.



**Preparing IPCU**

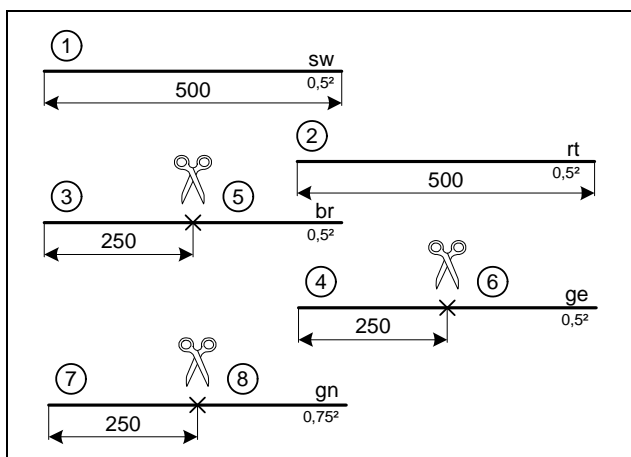

**Automatic air-conditioning**



Wire sections retain their numbering throughout the entire document.

**Cutting wires to length**

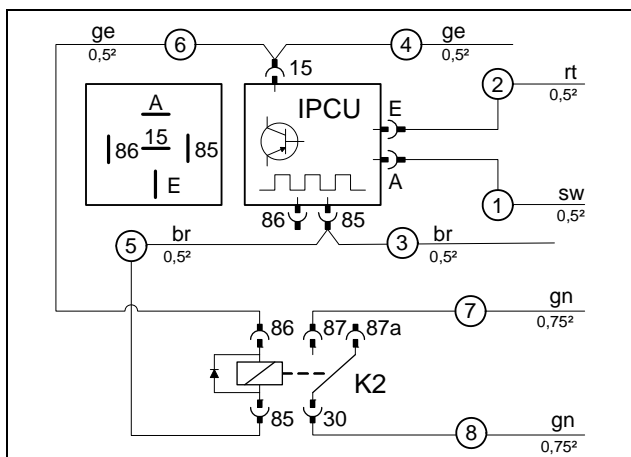

Connect lines to IPCU socket.  
IPCU view on contact side.



**Premounting IPCU and K2 relay**

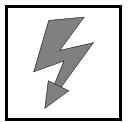

**Electrical System**

**Earth wire**

- 1 Earth wire on original vehicle earth support point

**Positive wire**

- 1 Positive wire on positive battery distributor

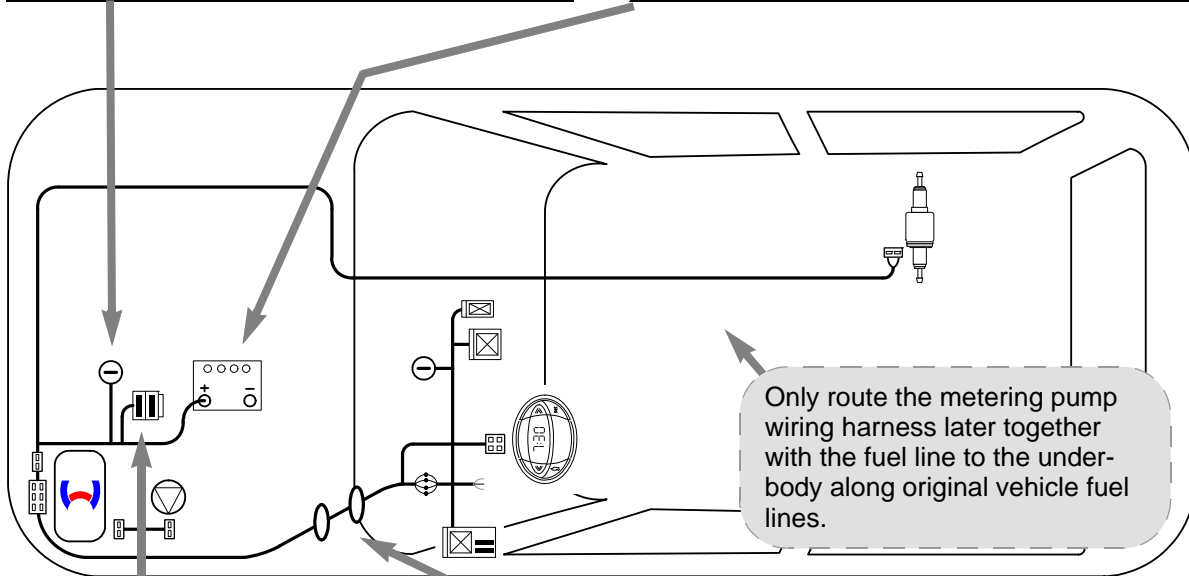
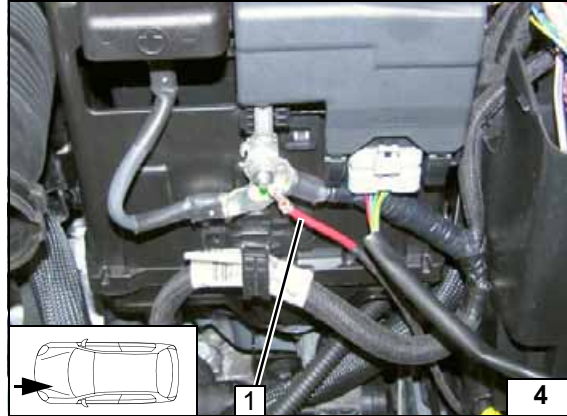
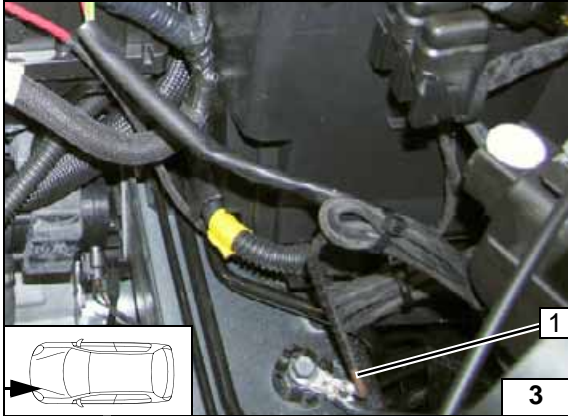

**Wiring harness routing diagram**

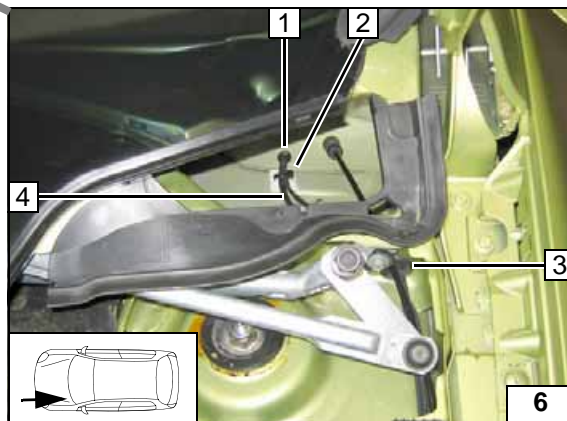
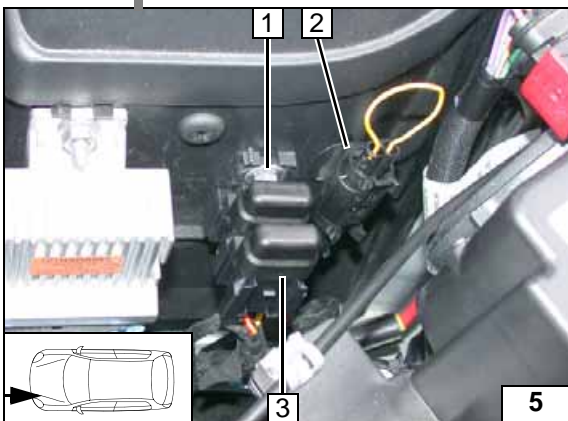

**Fuse holder of engine compartment**

- 1 5.5 mm dia. hole; M5x16 bolt, washer [2x], retaining plate of fuse holder, nut
- 2 6mm dia. hole, retaining clip, diagnosis connector
- 3 F1-2 fuses

**Wiring harness pass through**

- 1 Protective rubber plug
- 2 Adhesive base with cable tie
- 3 Protective rubber plug
- 4 Wiring harnesses of heater, heater controls





Fan Controller for Manual Air-Conditioning

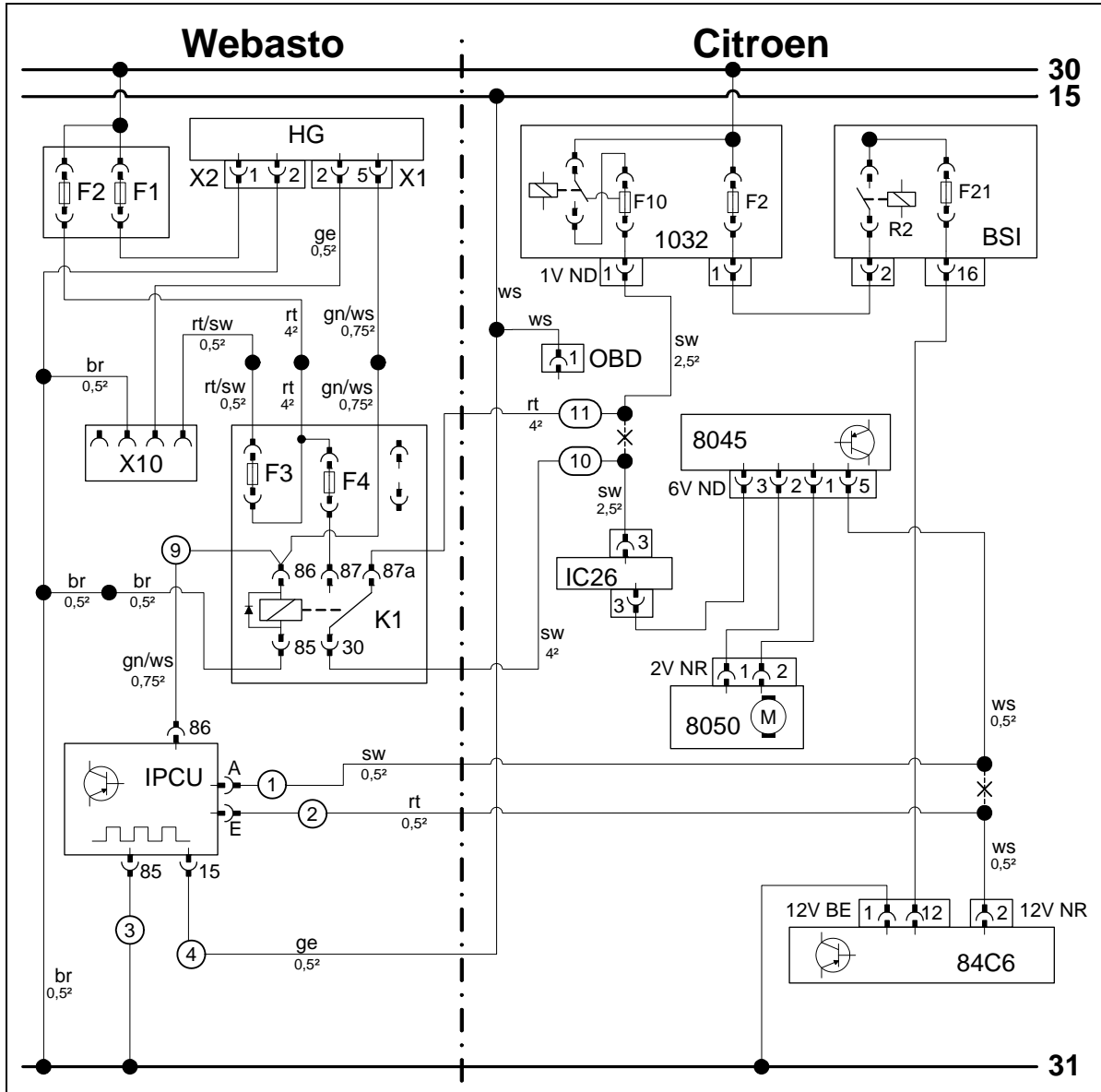

Wiring diagram

Webasto components		Vehicle components		Colours and symbols	
HG	TT-Evo heater	1032	Main power supply	rt	red
X1	6-pin heater connector	1V ND	Connector 1032	sw	black
X2	2-pin heater connector	BSI	Central electrical box for passenger compartment	ge	yellow
X10	4-pin connector of heater control	OBD	OBD connector	gn	green
K1	Fan relay	8045	Fan controller	ws	white
F1	20A fuse	6V ND	6-pin connector 8045	br	brown
F2	30A fuse	IC26	6-pin plug connection		
F3	1A fuse	2V NR	2-pin connector 8050		
F4	25A fuse	8050	Fan motor		
IPCU	Pulse width modulator	12V NR	12-pin connector 84C6		
		12V BE	12-pin connector 84C6		
		84C6	A/C control panel		
<b>IPCU settings:</b>					
Duty cycle: 70%					
Frequency: 400Hz					
Voltage: 12V				X	Cutting point
Function: Low-side					Wiring colours may vary.

Legend

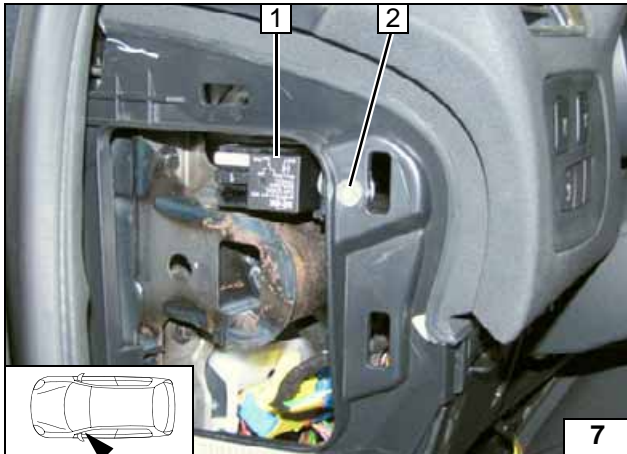

Countersink 6.5 mm dia. hole at position 2 .

- 1 Relay and fuse holder of passenger compartment
- 2 M6x12 countersunk head screw, large diameter washer, flanged nut



**Mounting passenger compartment relay and fuse holder**

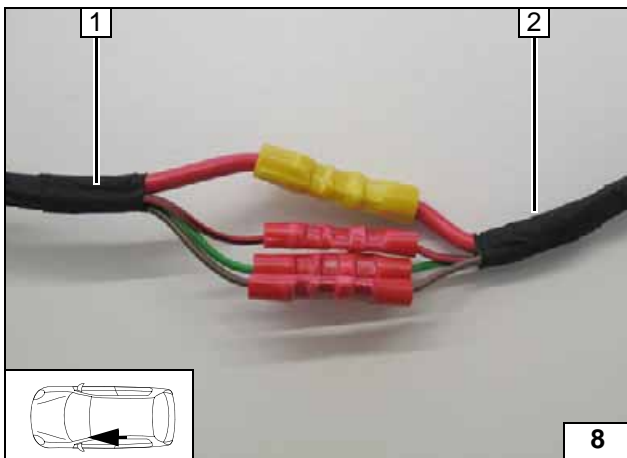

Connect wiring harness of passenger compartment relay and fuse holder 1 to wiring harness of heater 2 according to wiring diagram, in such a way that the wires of the same colour are connected to each other.



**Connecting passenger compartment wiring harnesses**

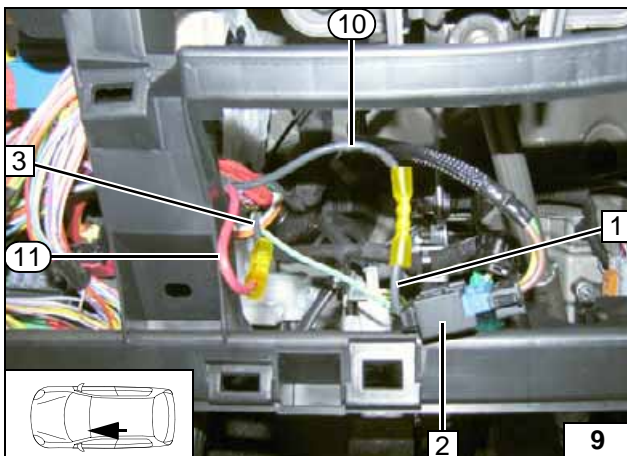

Connection on 6-pin connector 2. Produce connections as shown in wiring diagram.

- 1 Black (sw) wire of 6-pin connector
- 3 Black (sw) wire of F10 fuse
- ⑩ Black (sw) wire from K1/30
- ⑪ Red (rt) wire of K1/87a



**Connection of connector**

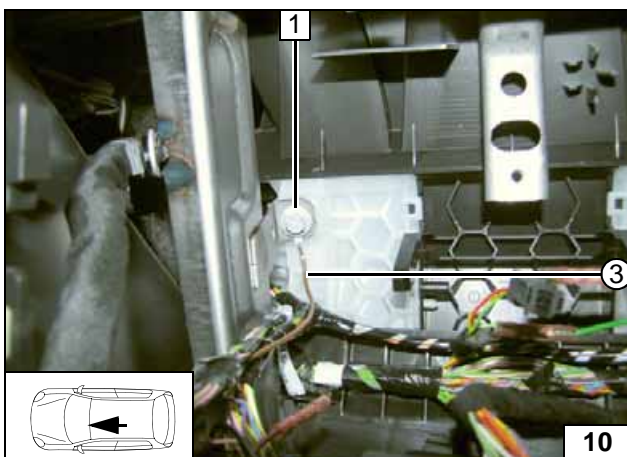

- 1 Original vehicle bolt
- ③ Brown (br) wire from IPCU/85

**IPCU earth connection**

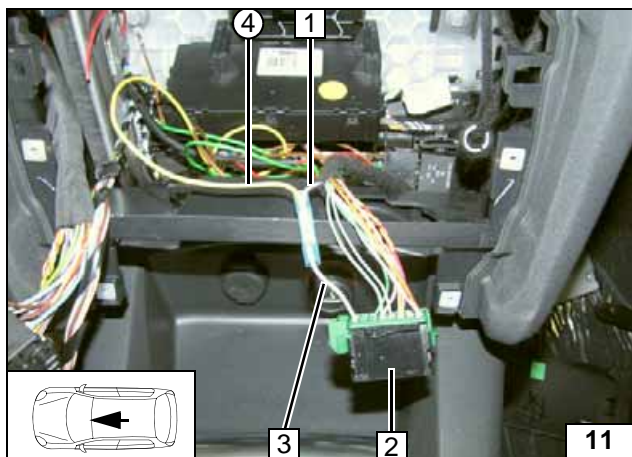

Connection to OBD socket outlet **2**.  
Produce connections as shown in wiring diagram.



- 1 White (ws) wire of Terminal 15
- 3 White (ws) wire of OBD socket outlet, pin 1
- ④ Yellow (ge) wire of IPCU/15

**Connec-  
tion of ter-  
minal 15**

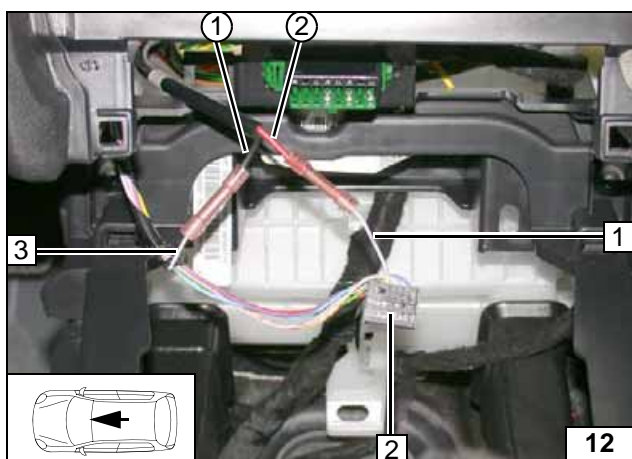

Connection on A/C control panel Produce connections as shown in wiring diagram.



- 1 White (ws) wire of connector 12V NR, Pin 2
- 2 Connector 12V NR
- 3 White (ws) wire of fan controller, Pin 5
- ① Black (sw) wire from IPCU/A
- ② Red (rt) wire from IPCU/E

**Connect-  
ing A/C  
control  
panel**

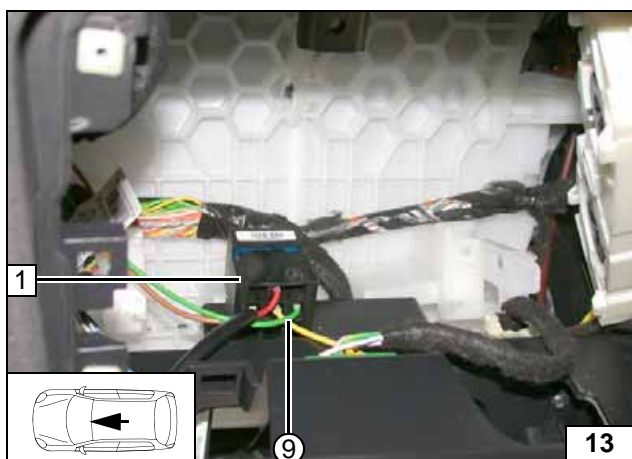

Connect green/white (gn/ws) wire ⑨ to IPCU/86.  
Fasten IPCU socket **1** with double-sided adhesive tape.



**Installing  
IPCU**

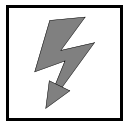

Fan Controller for Automatic Air-Conditioning

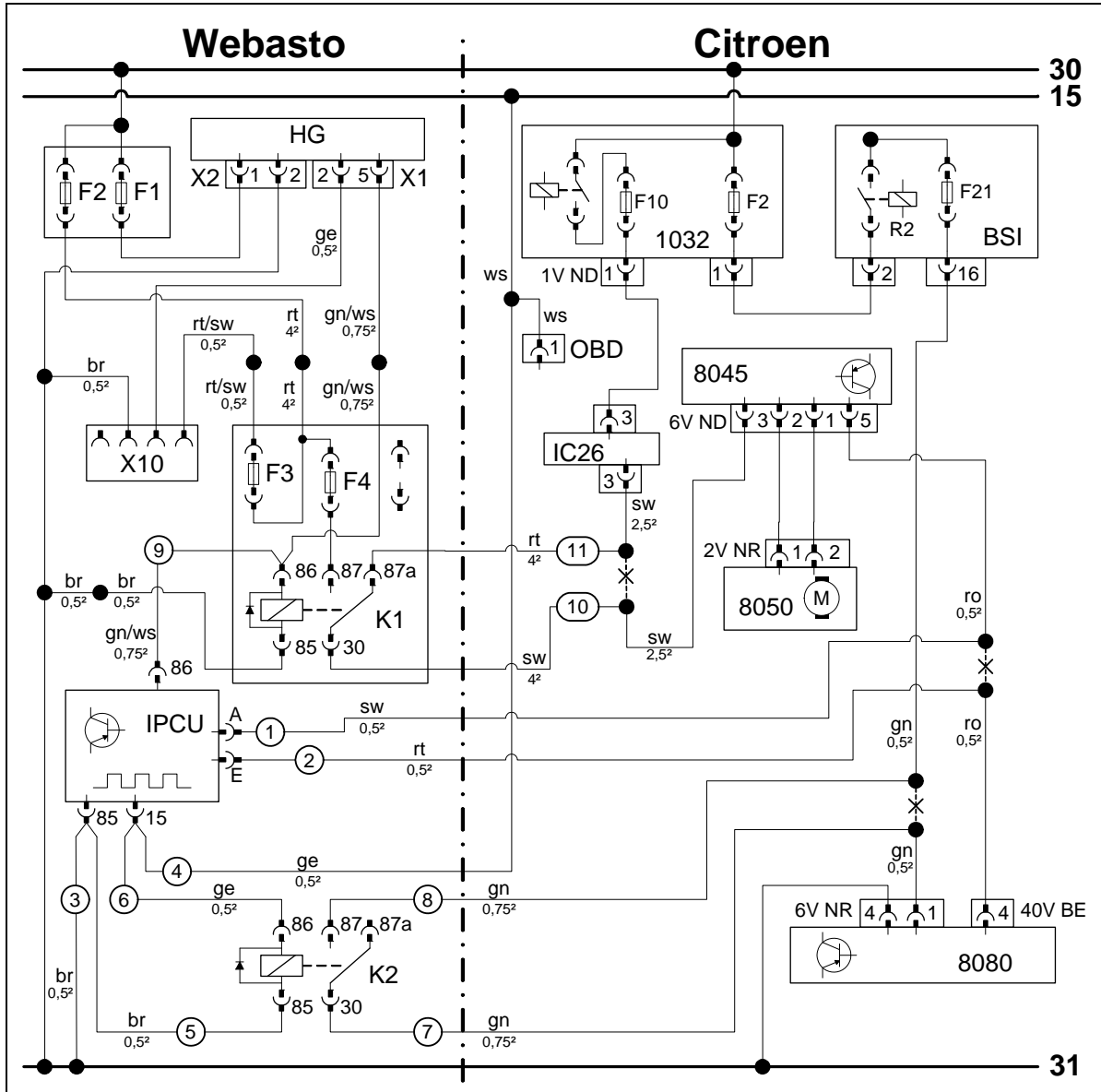

Wiring diagram

Webasto components		Vehicle components		Colours and symbols	
HG	TT-Evo heater	1032	Main power supply	rt	red
X1	6-pin heater connector	1V ND	Connector 1032	sw	black
X2	2-pin heater connector	BSI	Central electrical box for passenger compartment	ge	yellow
X10	4-pin connector of heater control	OBD	OBD connector	gn	green
K1	Fan relay	8045	Fan controller	ro	pink
F1	20A fuse	6V ND	6-pin connector 8045	ws	white
F2	30A fuse	IC26	6-pin plug connection	br	brown
F3	1A fuse	2V NR	2-pin connector 8050		
F4	25A fuse	8050	Fan motor		
K2	Additional relay	6V NR	6-pin connector 8080		
IPCU	Pulse width modulator	40V BE	40-pin connector 8080		
<b>IPCU settings:</b>					
Duty cycle: 70%					
Frequency: 400Hz					
Voltage: 12V				X	Cutting point
Function: Low-side				Wiring colours may vary.	

Legend

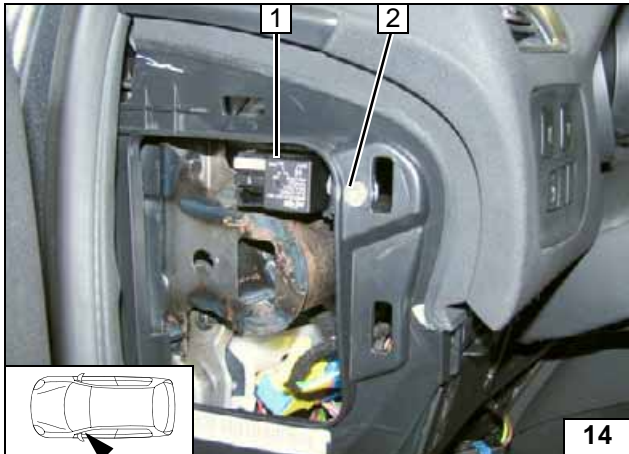

Countersink 6.5 mm dia. hole at position 2 .

- 1 Relay and fuse holder of passenger compartment
- 2 M6x12 countersunk head screw, large diameter washer, flanged nut



**Mounting passenger compartment relay and fuse holder**

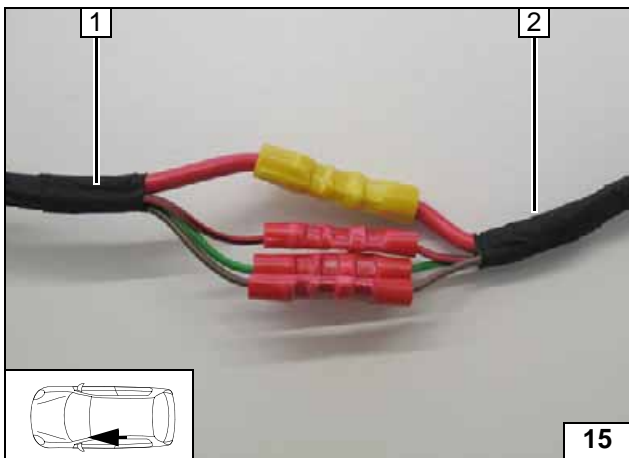

Connect wiring harness of passenger compartment relay and fuse holder 1 to wiring harness of heater 2 according to wiring diagram, in such a way that the wires of the same colour are connected to each other.



**Connecting passenger compartment wiring harnesses**

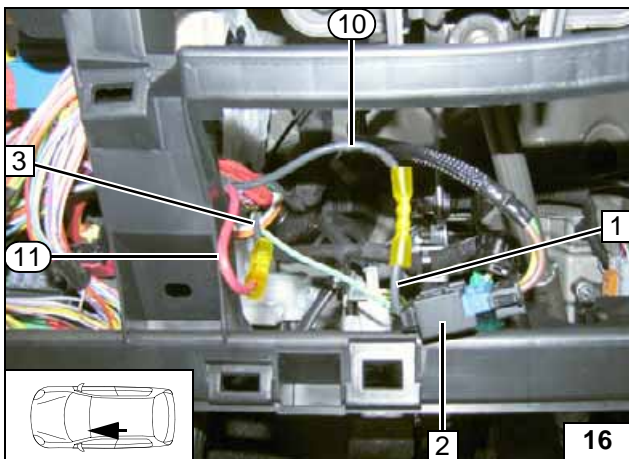

Connection on 6-pin connector 2. Produce connections as shown in wiring diagram.

- 1 Black (sw) wire of 6-pin connector
- 3 Black (sw) wire of F10 fuse
- ⑩ Black (sw) wire from K1/30
- ⑪ Red (rt) wire of K1/87a



**Connection of connector**

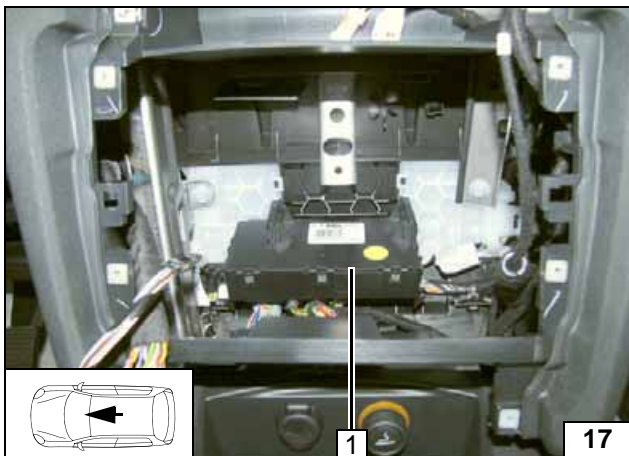

Pull off A/C control unit 1.



**Detaching A/C control unit**

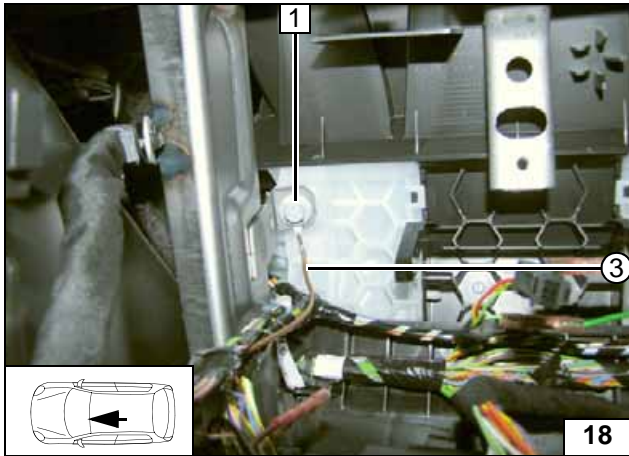
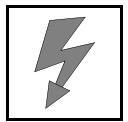

- 1 Original vehicle bolt
- ③ Brown (br) wire from IPCU/85

IPCU earth connection

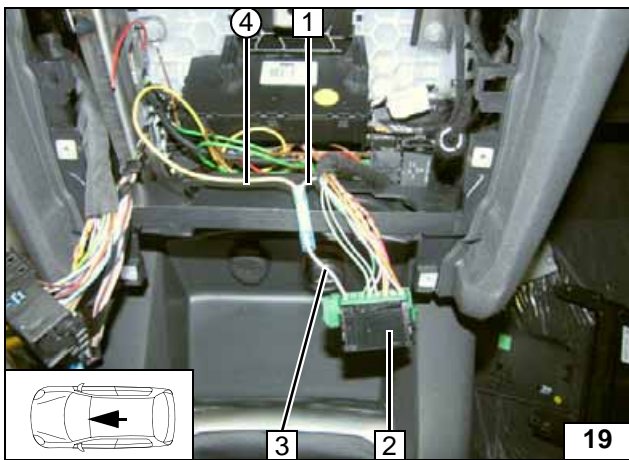

Connection to OBD socket outlet 2. Produce connections as shown in wiring diagram.

- 1 White (ws) wire of Terminal 15
- 3 White (ws) wire of OBD socket outlet, pin 1
- ④ Yellow (ge) wire of IPCU/15

Connection of terminal 15

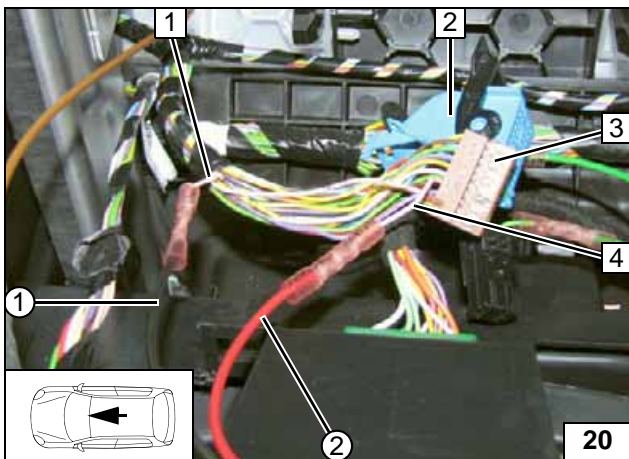

Connecting to A/C control unit. Detach brown (br) connector half 3 (20-pin, pin1-20) from connector 40V BE 2 of A/C control unit. Produce connections as shown in wiring diagram.

- 1 Pink (ro) wire of fan controller, Pin 5
- 4 Pink (ro) wire of brown (br) connector, pin 4
- ① Black (sw) wire from IPCU/A
- ② Red (rt) wire from IPCU/E

Connecting A/C control unit

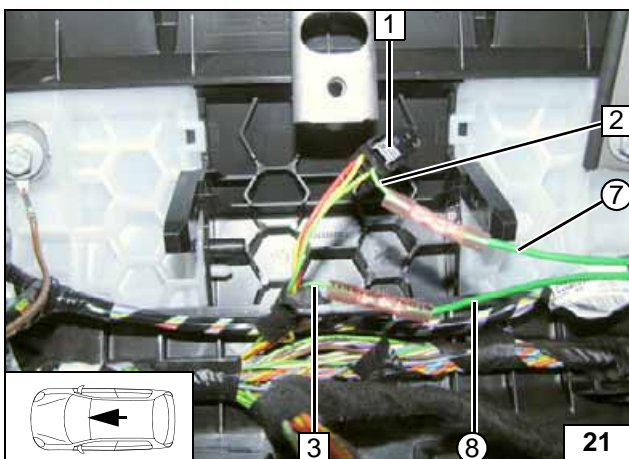

Connection to 6-pin connector 6V NR 1 from A/C control unit. Produce connections as shown in wiring diagram.

- 2 Green (gn) wire of 6-pin connector, pin 1
- 3 Green (gn) wire of Can+
- ⑦ Green (gn) wire from K2/30
- ⑧ Green (gn) wire from K2/87

Connecting A/C control unit

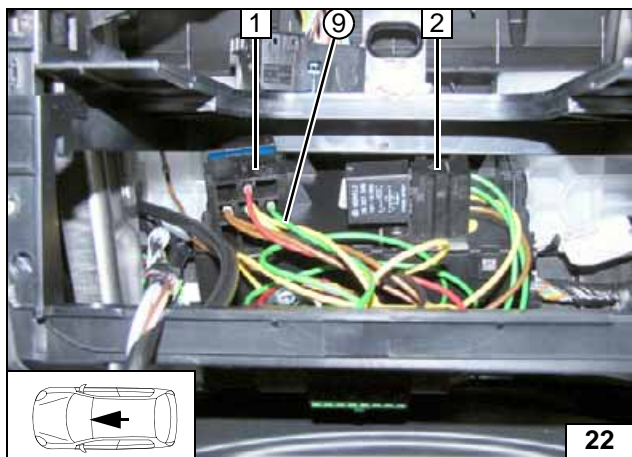

Install radio duct. Mount A/C control unit. Connect green/white (gn/ws) wire ⑨ to IPCU/86. Fasten IPCU socket 1 and K2 relay socket 2 with adhesive tape on A/C control unit with adhesive tape.



**Installing  
IPCU and  
K2 relay**



### Digital Timer

1 Digital timer



Installing digital timer

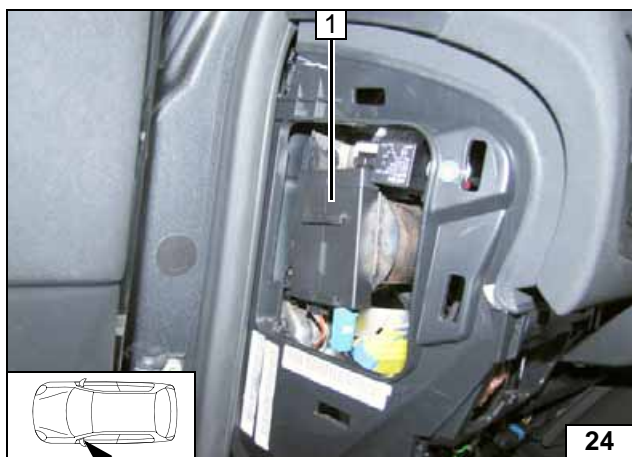

### Remote Option (Telestart)

Fasten receiver 1 with adhesive tape.



Installing receiver

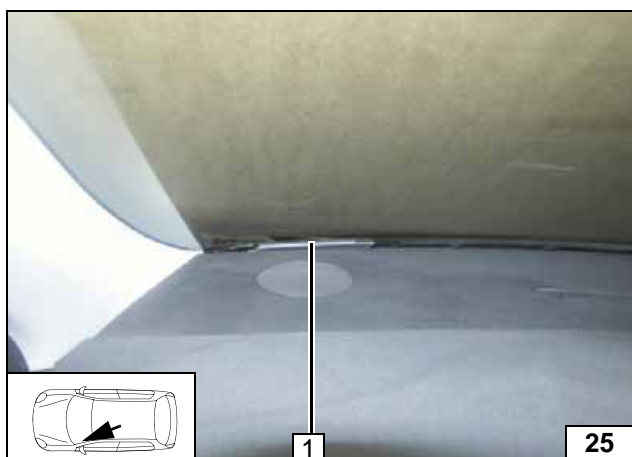

1 Antenna

Installing antenna

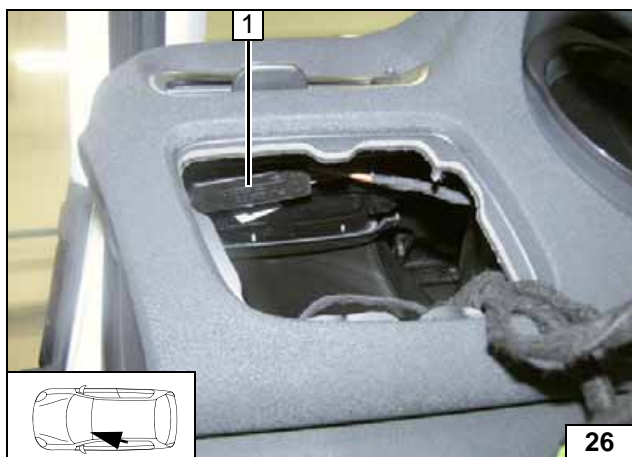

### Temperature sensor T100 HTM

Fasten temperature sensor 1 with adhesive tape.



Installing temperature sensor



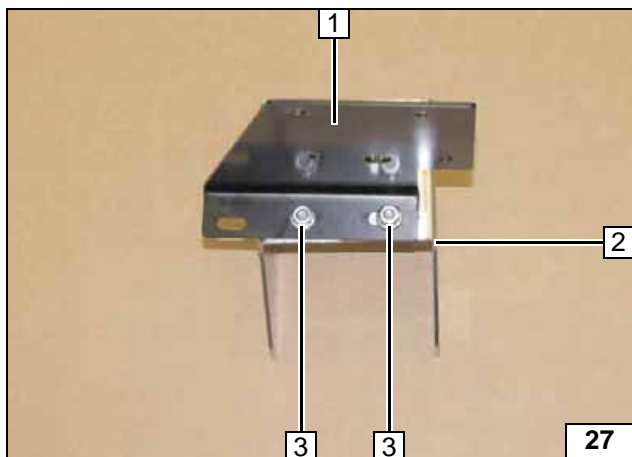

### Preparing Installation Location

- 1 Retaining plate
- 2 Bracket
- 3 M6x16 bolt, flanged nut [2x each]

Premounting bracket

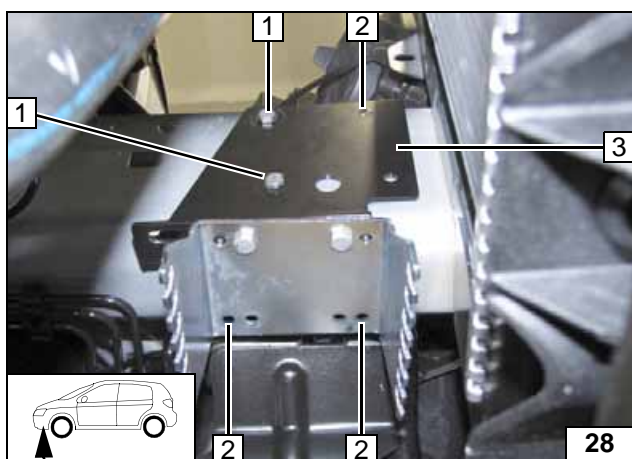

- 1 M6x20 bolt, existing threaded hole [2x]
- 2 Copy hole pattern [3x]
- 3 Install retaining plate loosely

Copying hole pattern

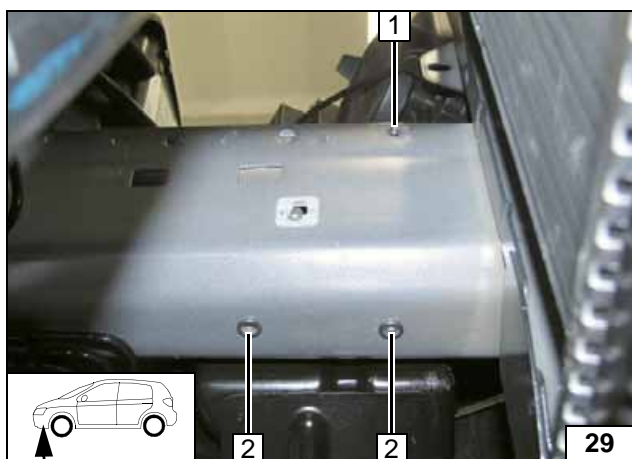

Remove retaining plate with bracket.

- 1 7 mm dia. hole
- 2 9.1mm dia. hole; rivet nut [2x each]

Installing rivet nut

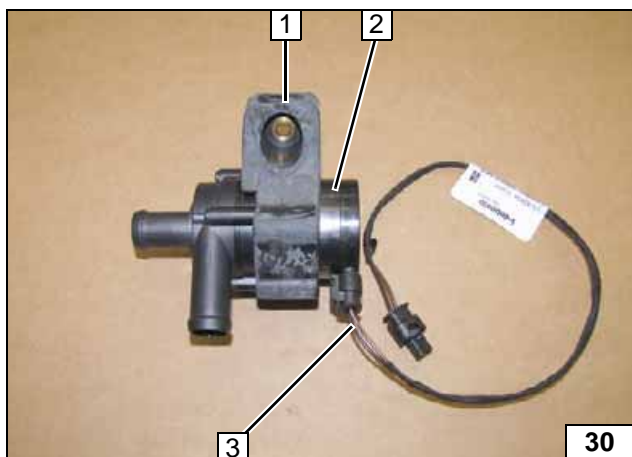

- 1 Circulating pump mounting
- 2 Circulating pump
- 3 Wiring harness of circulating pump

Premounting circulating pump

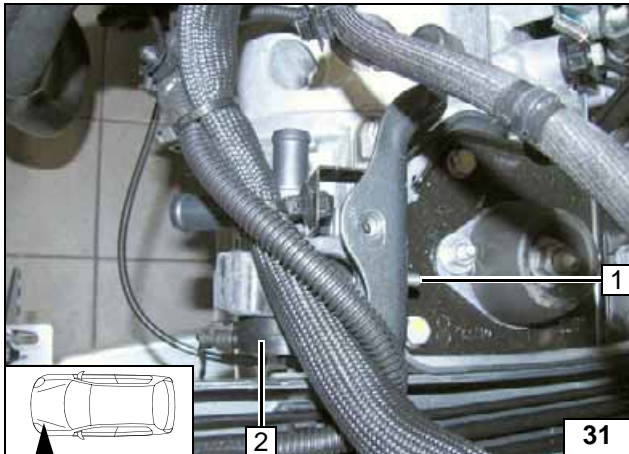

Remove original vehicle bolt at position 1 and discard.

- 1 M6x25 bolt, existing threaded hole
- 2 Circulating pump



**Mounting circulating pump**

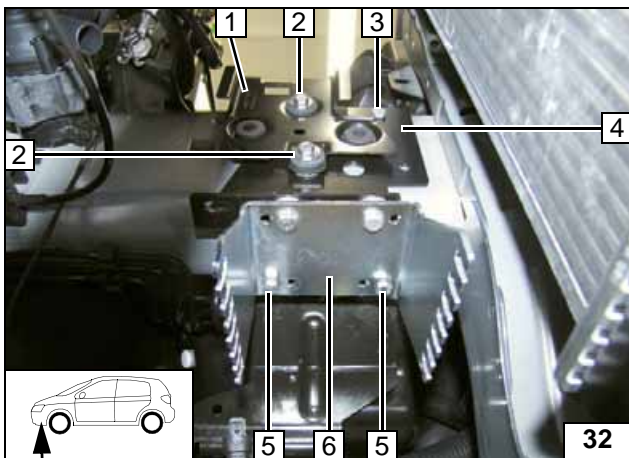

Insert one 20 mm shim each between bracket 6 and frame side member at position 5 .

- 1 Bracket of air filter
- 2 Original vehicle bolt [2x] bracket of air filter
- 3 M6x16 bolt, flanged nut
- 4 Retaining plate
- 5 M6x40 bolt, spring lockwasher, 20mm shim



**Installing bracket**

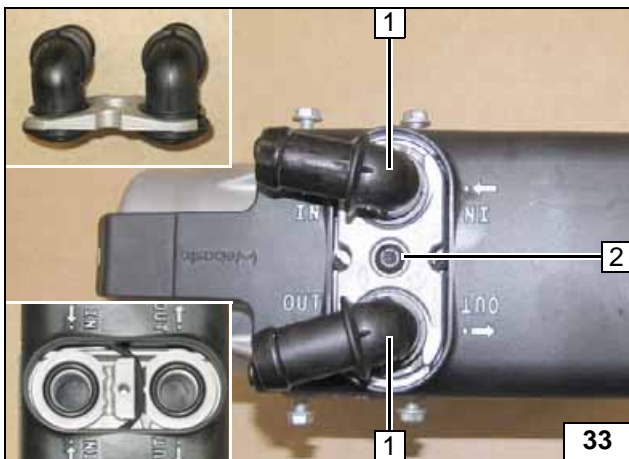

**Preparing Heater**

- 1 Water connection piece, sealing ring [2x each]
- 2 5x15 self-tapping bolt, retaining plate of water connection pieces



**Installing water connection pieces**

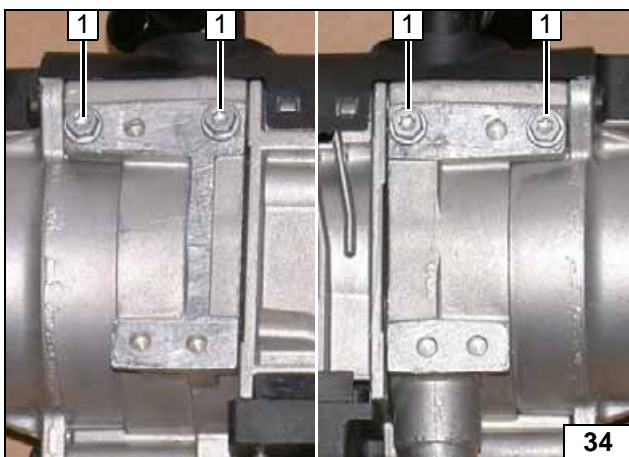

Screw 5x13 self-tapping bolts 1 [4x] into existing holes by a maximum of 3 thread turns.



**Pre-mounting bolts loosely**

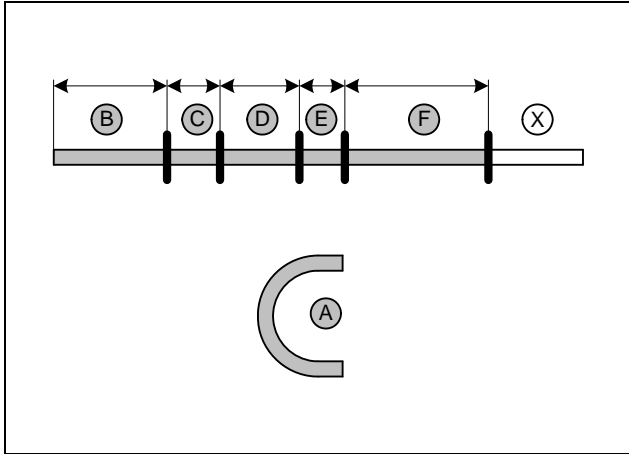
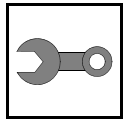

Discard section **X**.  
Hose **A** = 18mm dia., 180° moulded hose

- B** = 350
- C** = 60
- D** = 170
- E** = 60
- F** = 670



**Cutting hoses to length**

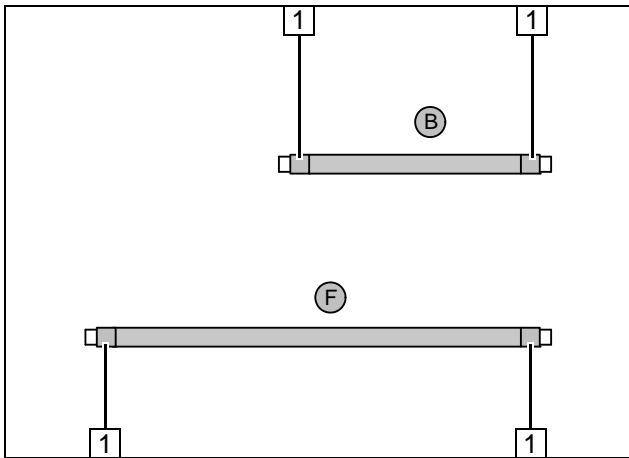

Push braided protection hoses onto hose **B** and **F** and cut to length.  
Cut heat shrink plastic tubing to size.

- 1** 50 mm long heat shrink plastic tubing [4x]



**Preparing hoses**

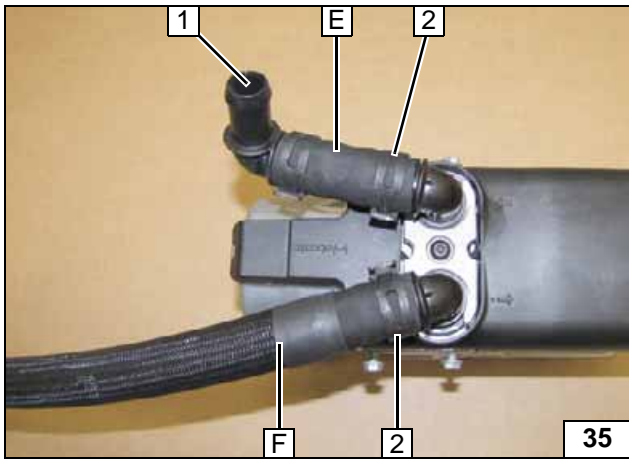

- 1** 90°, 18x18mm connecting pipe, 25mm dia. spring clip
- 2** 25mm dia. spring clip [2x]

**Premounting hoses**

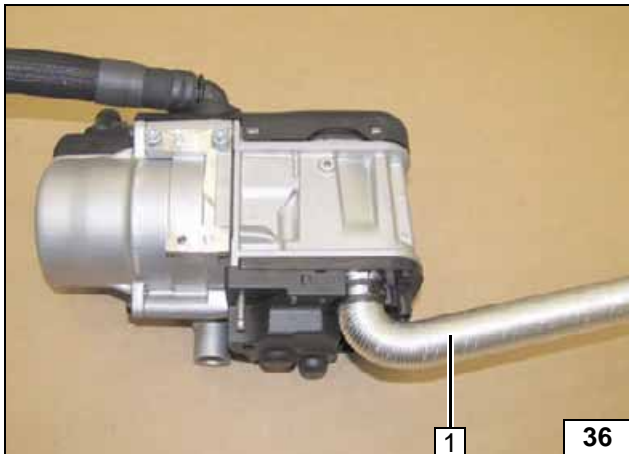

- 1** Combustion air pipe



**Premounting combustion air pipe**

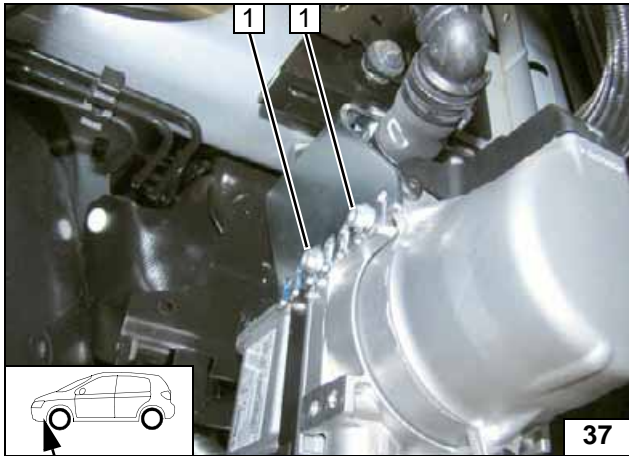
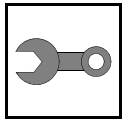

### Installing Heater

- 1 Tighten 5x13 self-tapping bolt [2x]

Installing heater

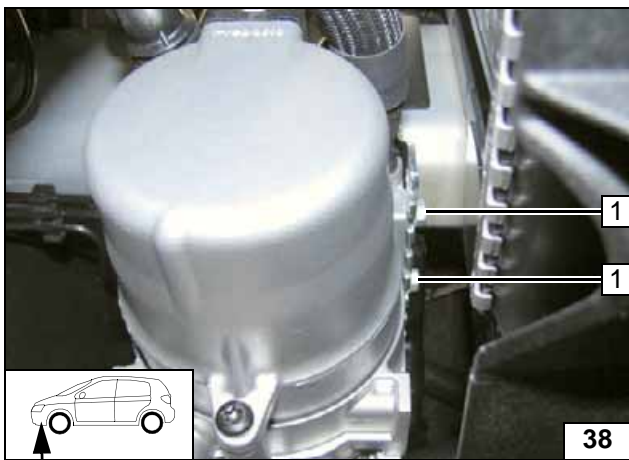

- 1 Tighten 5x13 self-tapping bolt [2x]

Installing heater

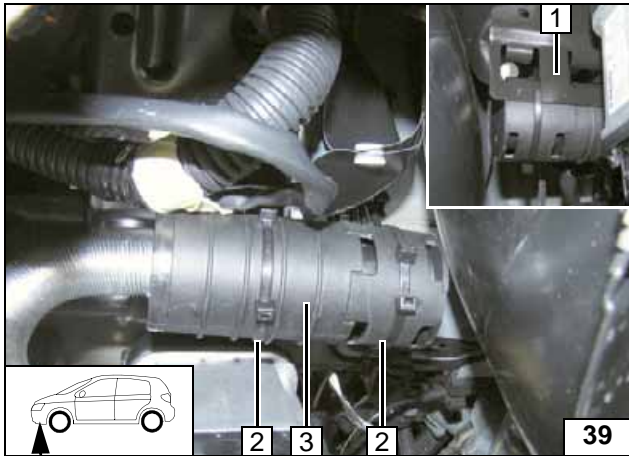
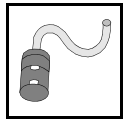

### Combustion Air

- 1 ABS bracket
- 2 Cable tie [2x each]
- 3 Silencer

### Installing silencer

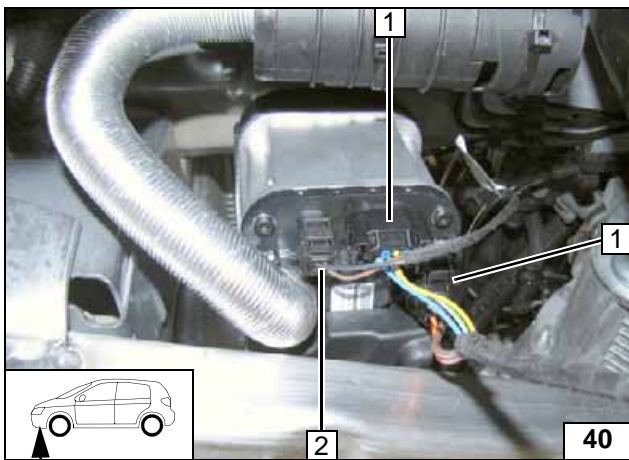

- 1 Wiring harness of heater [2x]
- 2 Wiring harness of circulating pump

### Mounting wiring harnesses

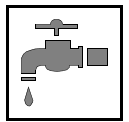



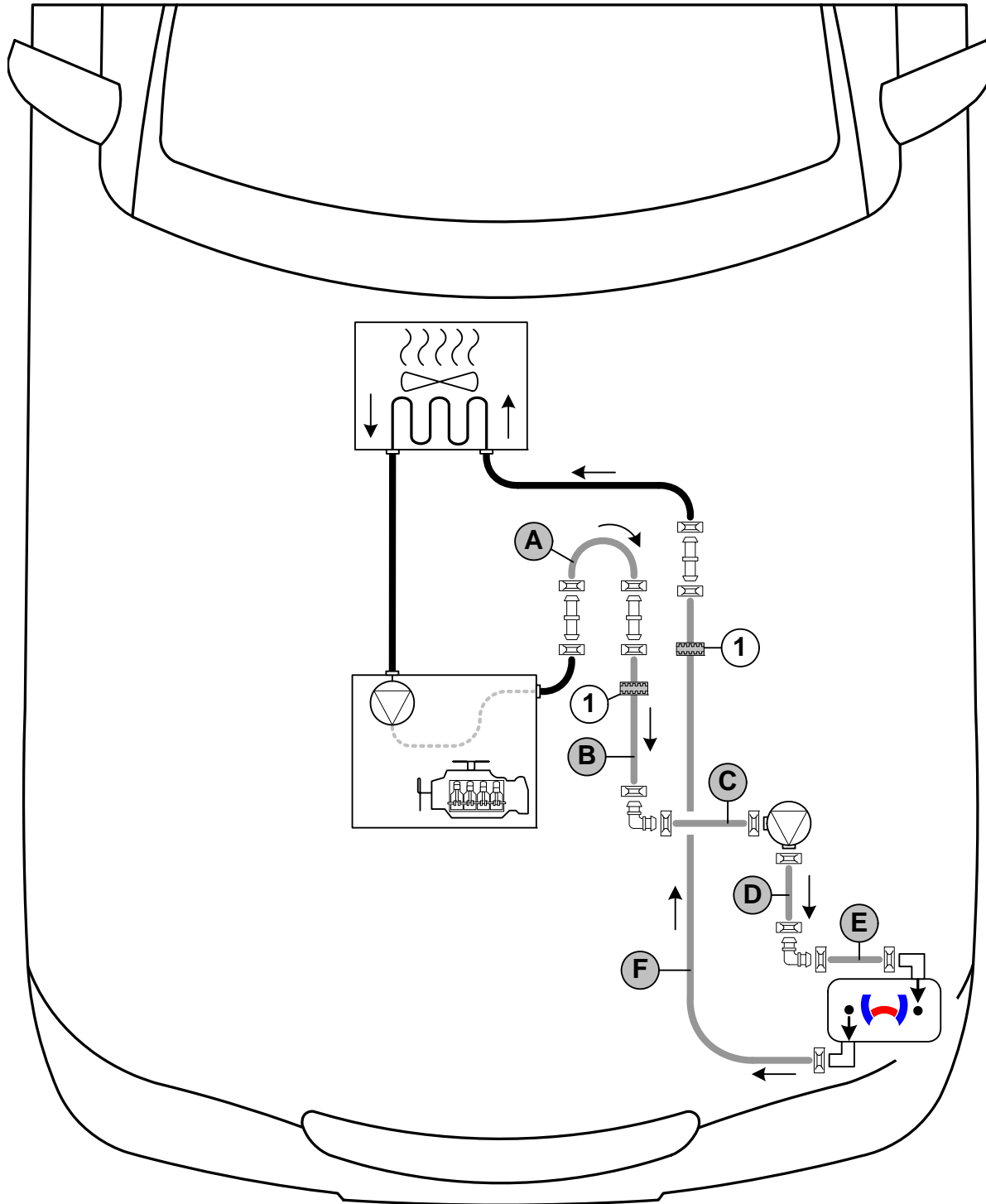

## Coolant Circuit

### WARNING!

Any coolant running off should be collected in an appropriate container. Route hoses so that they are kink-free. Unless specified otherwise, always fasten using cable ties. Position clamps so that other hoses cannot be damaged. When installing the hoses, the heater must be filled with coolant. The connection should be "inline" based on the following diagram:



Hose routing diagram

All spring clips  = 25 mm dia.  
 1 = Black (sw) rubber isolator  [2x].  
 All connecting pipes  and  = 18x18 mm dia.



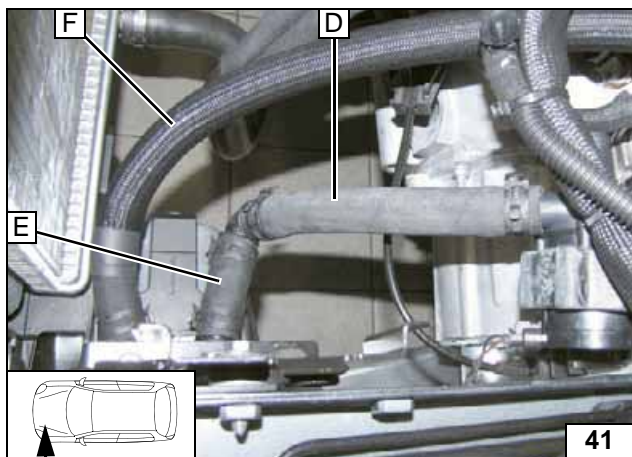
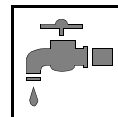

Connect-  
ing circu-  
lating  
pump

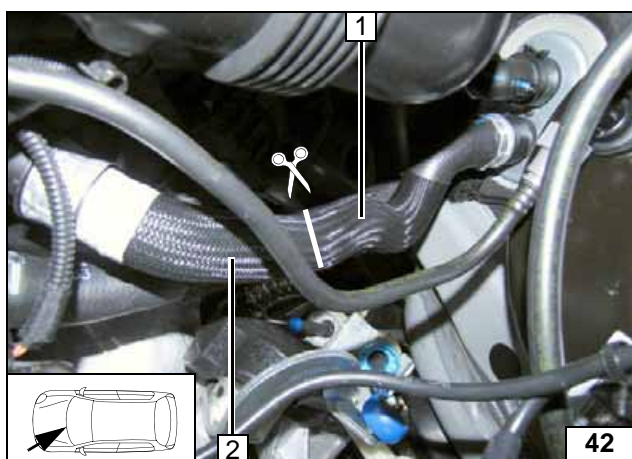

Cut off hose on engine outlet/heat exchanger inlet at marking. Remove braided protective hose from both hose sections.



- 1 Hose section of heat exchanger inlet
- 2 Hose section of engine outlet

Cutting  
point

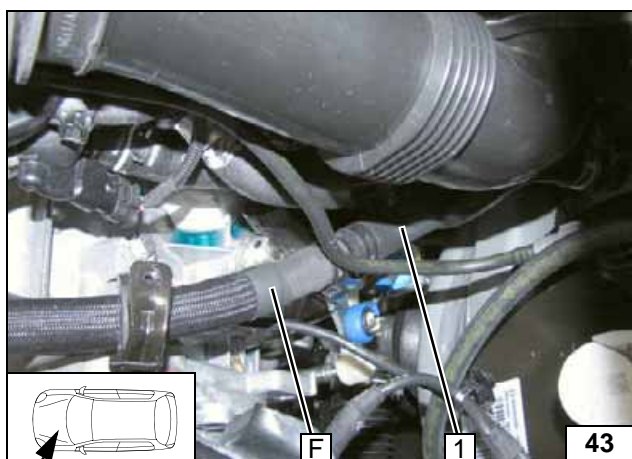

- 1 Hose of heat exchanger inlet

Connect-  
ing heat ex-  
changer  
inlet

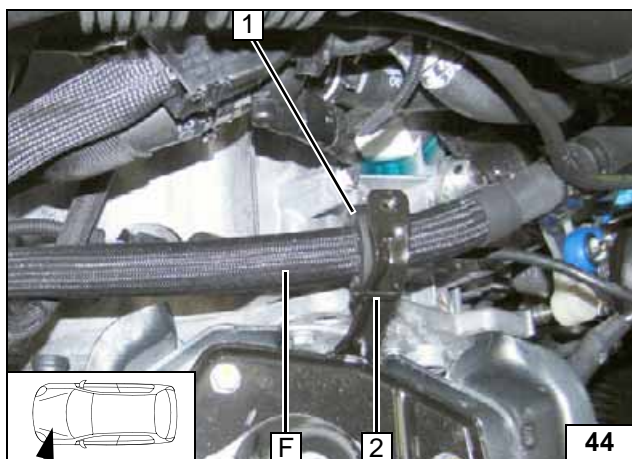

- 1 Slide on black (sw) rubber isolator and align
- 2 Cable tie

Routing in  
engine com-  
part-  
ment

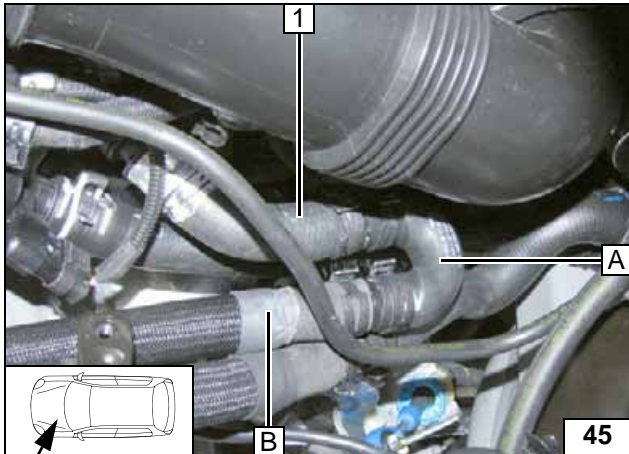

1 Hose of engine outlet

Connect-  
ing engine  
outlet

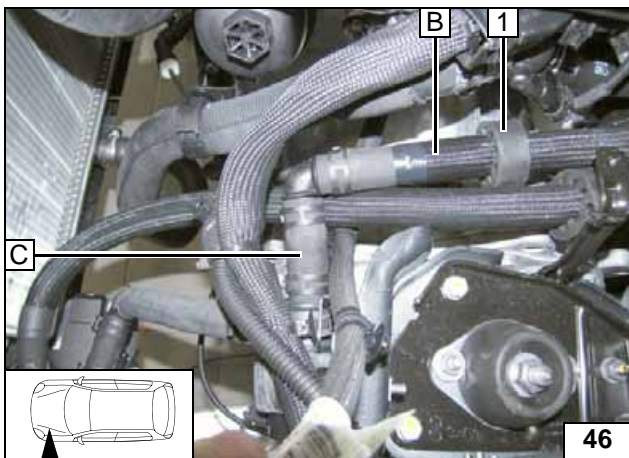

1 Slide on black (sw) rubber isolator and position

Connect-  
ing circu-  
lating  
pump

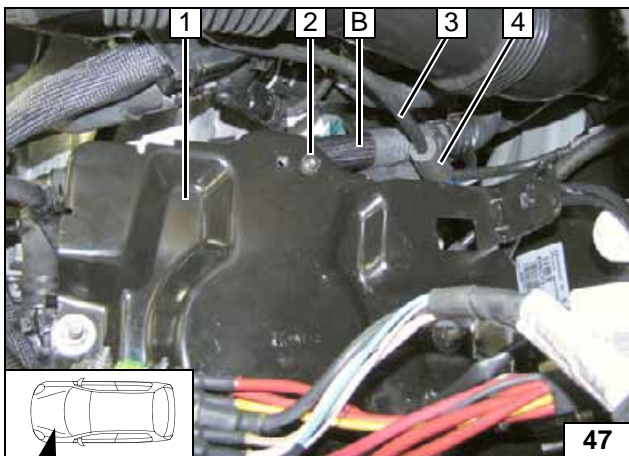

Shorten original vehicle bolt **2** by 5mm. Wind vacuum line **3** with rub protection **4**. Align hoses. Ensure sufficient distance from neighbouring components.

1 Battery carrier



Install-  
ing  
battery car-  
rier



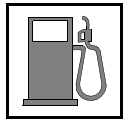

**Fuel**

**CAUTION!**

Open the vehicle's fuel tank cap, ventilate the tank and then re-close the tank lock.

Catch any fuel running off in an appropriate container.

Install fuel line and metering pump wiring harness so that they are protected against stone impact. Unless specified otherwise, always fasten using cable ties.

Mount the fuel line and wiring harness with rub protection on sharp edges.

**WARNING!**

The fuel line and wiring harness are routed to the metering pump as shown in the wiring harness routing diagram.

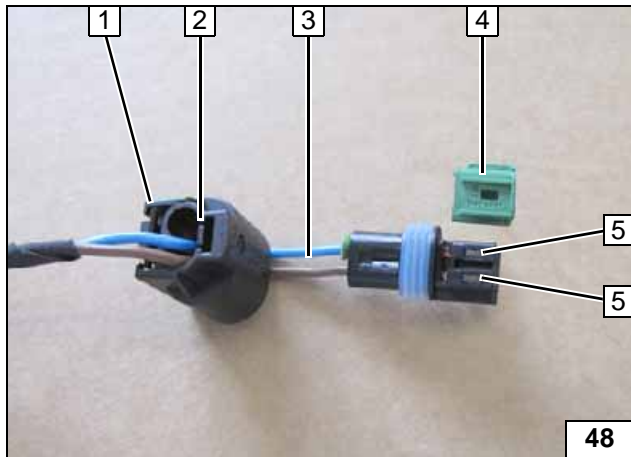

Complete connector of metering pump after routing. Pin assignment is not relevant.

- 1 Connector housing
- 2 Lock
- 3 Blue / brown (bl / br) wires
- 4 Coding
- 5 Timer lock



**Dismantling connector**

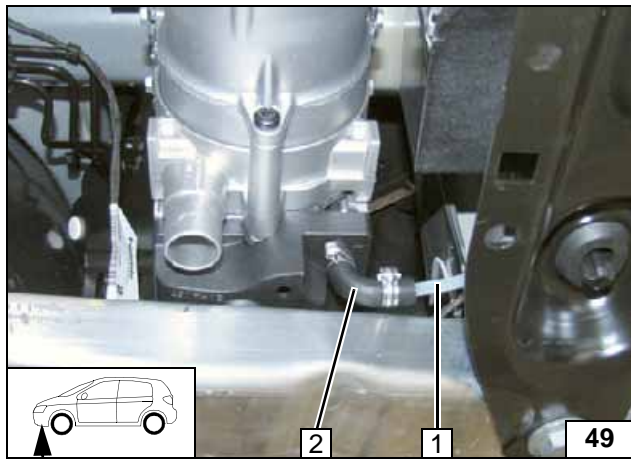

- 1 Fuel line
- 2 90° moulded hose, 10mm dia. clamp [2x]

**Connecting heater**

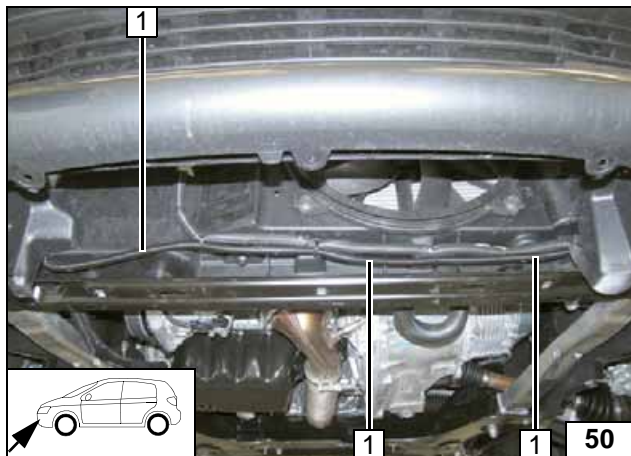

Route fuel line and wiring harness of metering pump into 2100mm corrugated tube 1 to the right vehicle side.



**Routing lines**

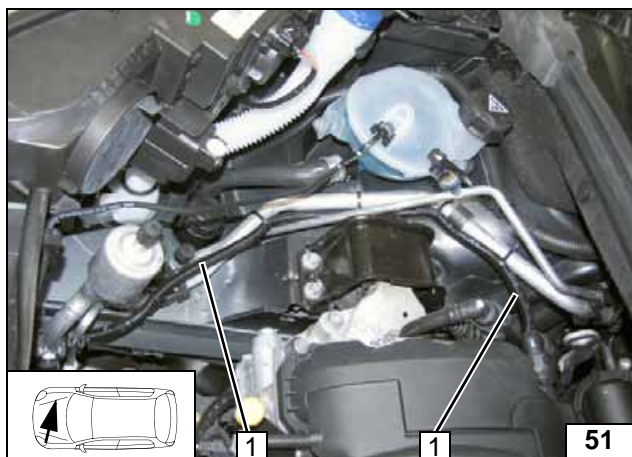

Route fuel line and wiring harness of metering pump into corrugated tube 1 along the A/C line to the firewall.



Routing lines

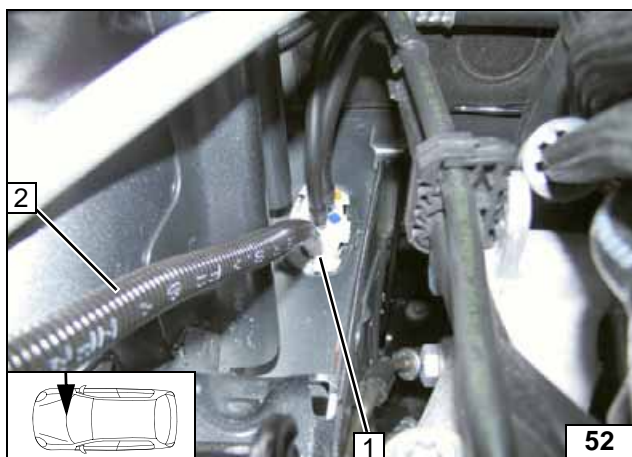

Route fuel line and wiring harness of metering pump in original vehicle line duct to the underbody.



Routing lines

- 1 Original vehicle pass through
- 2 Fuel line and wiring harness of metering pump in corrugated tube

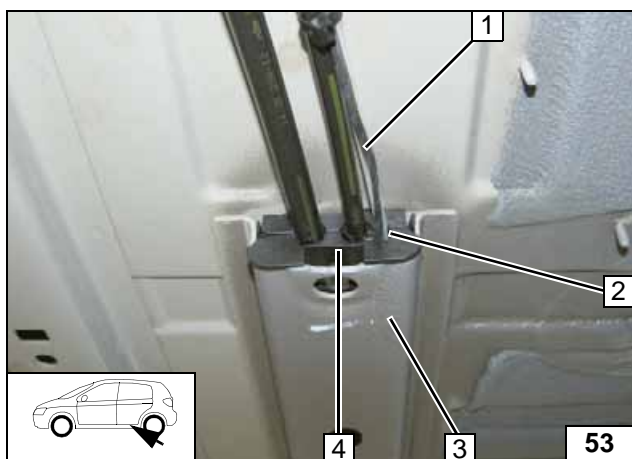

8mm dia. hole at position 2 in original vehicle sealing 4!



Routing lines

- 1 Fuel line, wiring harness of metering pump
- 3 Original vehicle line duct

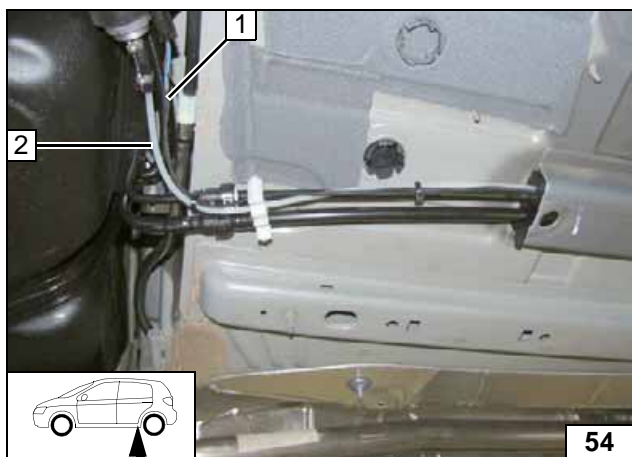

- 1 Wiring harness of metering pump
- 2 Fuel line

Routing lines

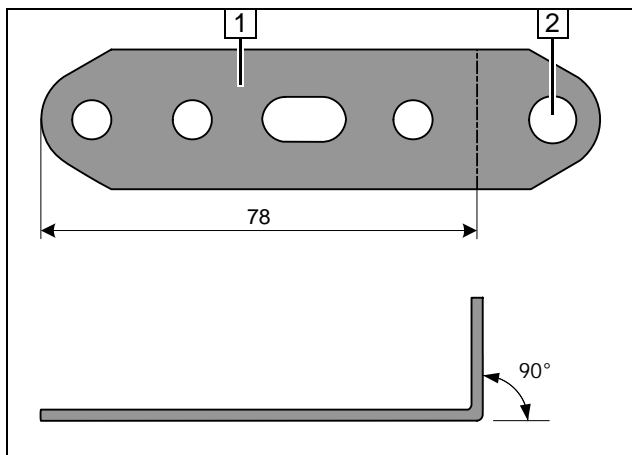

- 1 Perforated bracket
- 2 Drill out 9 mm dia. hole

Preparing perforated bracket

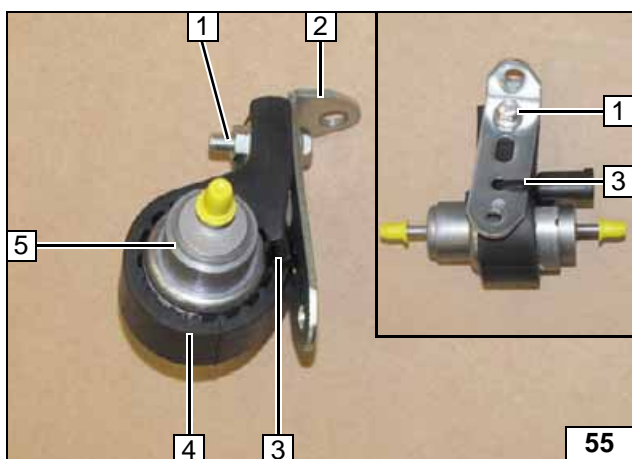

- 1 M6x25 bolt, flanged nut
- 2 Perforated bracket
- 3 Cable tie
- 4 Mounting of metering pump
- 5 Metering pump

Premounting metering pump

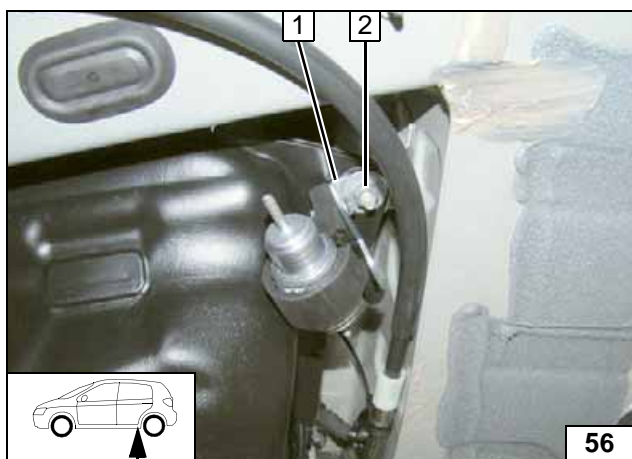

- 1 Perforated bracket
- 2 Original vehicle bolt

Mounting metering pump

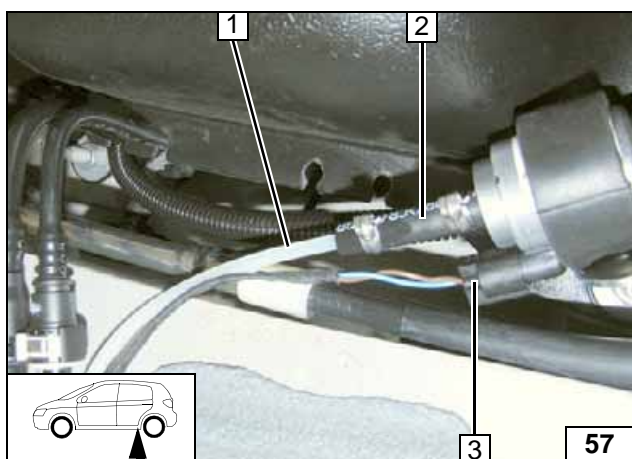

- 1 Fuel line of heater
- 2 Hose section, 10mm dia.clamp [2x]
- 3 Wiring harness of metering pump, connector mounted

Connecting metering pump

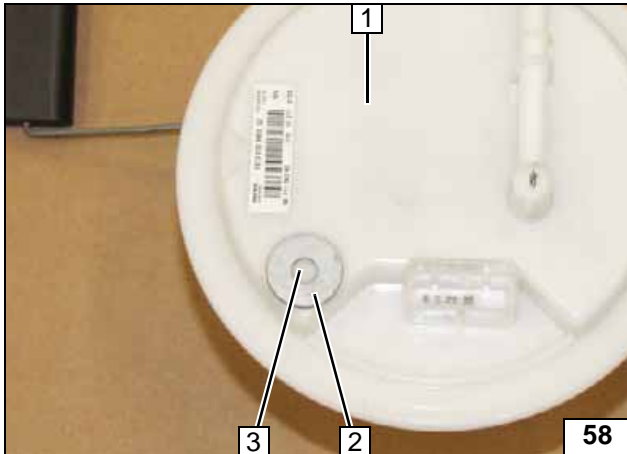
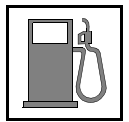

Remove fuel-tank sending unit **1** in accordance with the manufacturer's instructions.

- 2** Washer with outer dia.  $d_a = 21.6\text{mm}$
- 3** Copy hole pattern, 6mm dia. hole



**Fuel extraction**

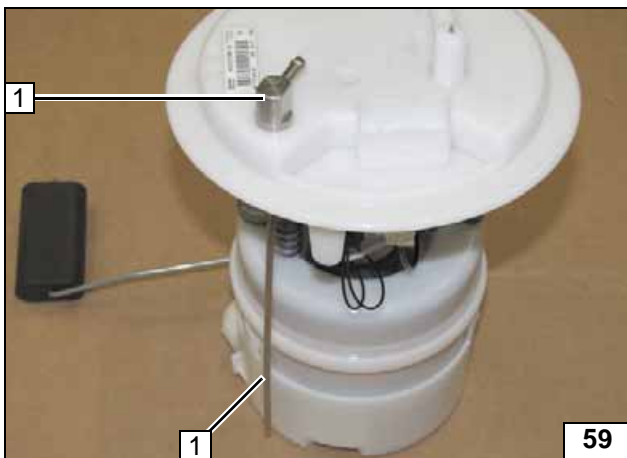

Shape fuel standpipe **1** according to template, cut to length and install.



**Installing fuel standpipe**

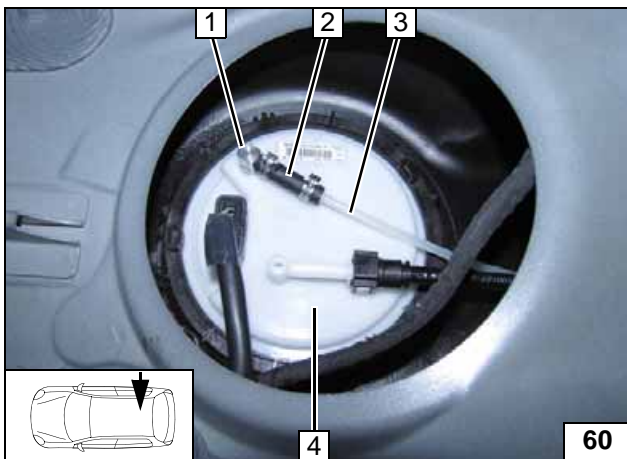

Install fuel-tank sending unit **4** in accordance with the manufacturer's instructions.

- 1** Fuel standpipe
- 2** Hose section, 10mm dia.clamp [2x]
- 3** Fuel line



**Connecting fuel line**

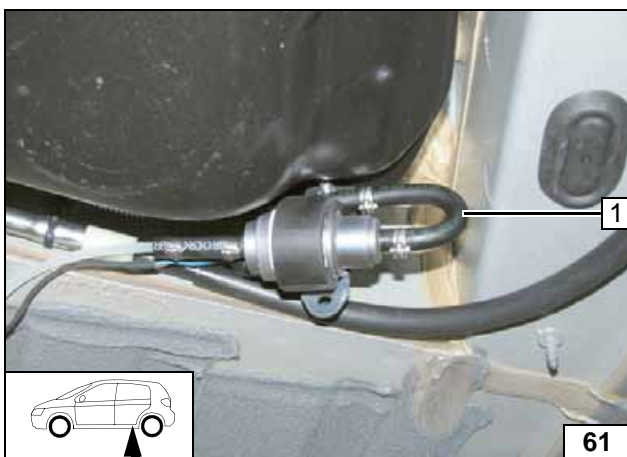

Check the position of the components; adjust if necessary. Check that they have freedom of movement.

- 1** Fuel line, 180° moulded hose, 10mm dia. clamp [2x]



**Connecting metering pump**

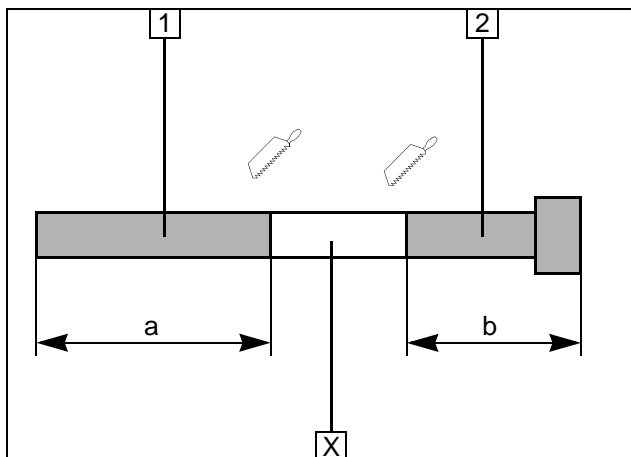
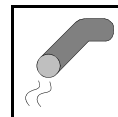

### Exhaust Gas

Discard section X.

- 1 Exhaust pipe  
a = 70
- 2 Exhaust end section  
b = 220

Preparing exhaust pipe

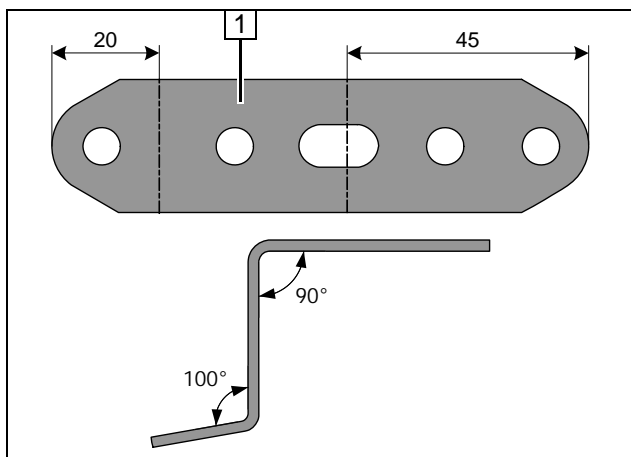

- 1 Perforated bracket

Angling down perforated bracket

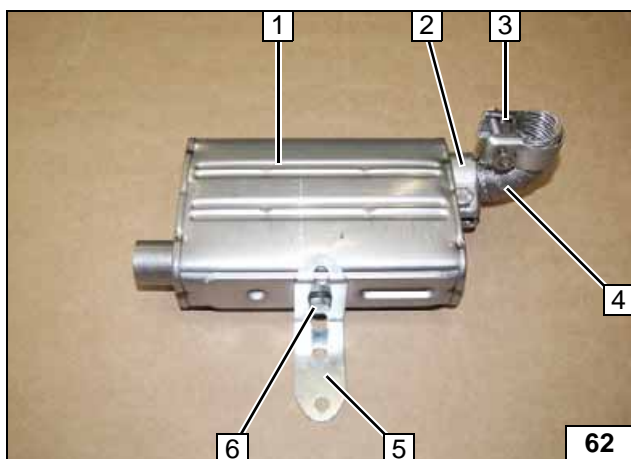

- 1 Silencer
- 2 Hose clamp
- 3 Mount hose clamp
- 4 Exhaust pipe
- 5 Perforated bracket
- 6 M6x16 bolt, spring lockwasher

Installing silencer

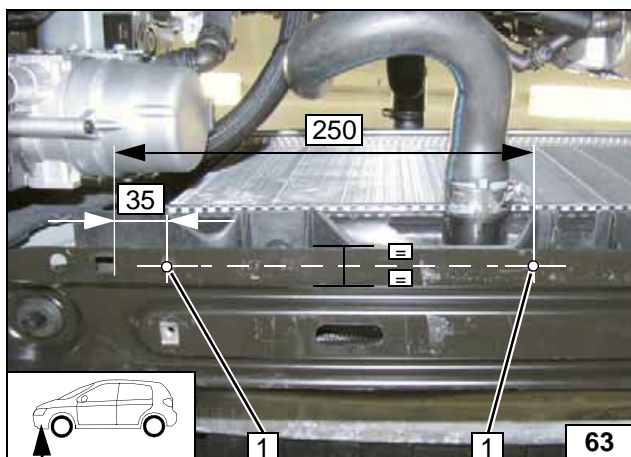

- 1 7mm dia. hole [2x]

Holes in cross member

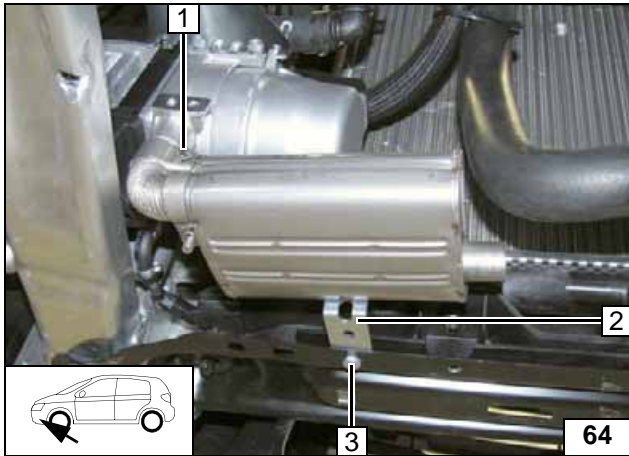
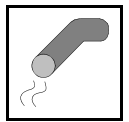

- 1 Tighten hose clamp
- 2 Perforated bracket
- 3 M6x12 bolt, flanged nut

**Installing silencer**

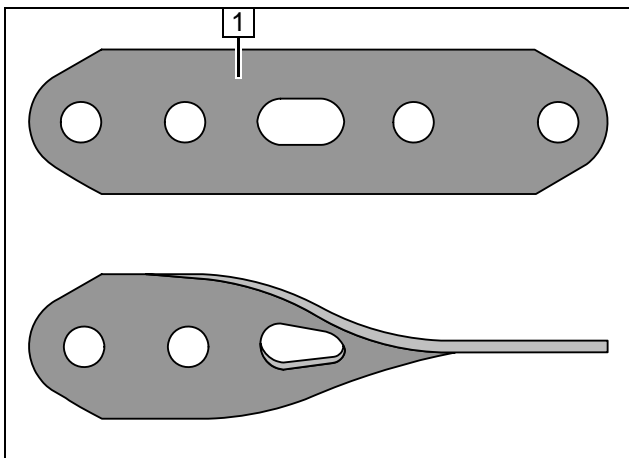

- 1 Twist 90° perforated bracket in longitudinal axis

**Preparing perforated bracket**

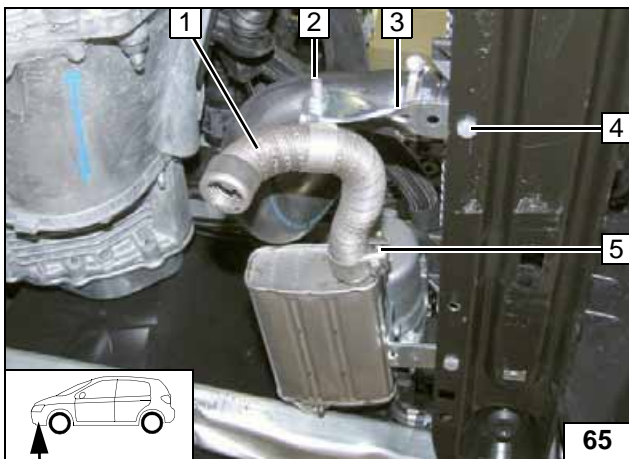

- 1 Exhaust end section
- 2 M6x20 bolt, p-clamp, flanged nut
- 3 Perforated bracket
- 4 M6x12 bolt, flanged nut
- 5 Hose clamp

**Installing exhaust end section**

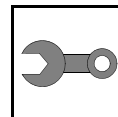

## Final Work

### WARNING!

Mount removed parts in reverse order. Check all hoses, clamps and all electrical connections for firm seating. Insulate all loose wires and tie back. Only use manufacturer-approved coolant. Spray the heater components with anti-corrosion wax (Tectyl 100K, Order No. 111329).



- **Connect the battery.**
- **Fill and bleed the coolant circuit according to the vehicle manufacturer's specifications.**
- **Adjust digital timer, teach telestart transmitter.**
- **No settings needed on the A/C control panel**
- **Place the "Switch off parking heater before refuelling" caution label in the area of the filler neck.**
- **For initial startup and function check, please see installation instructions.**

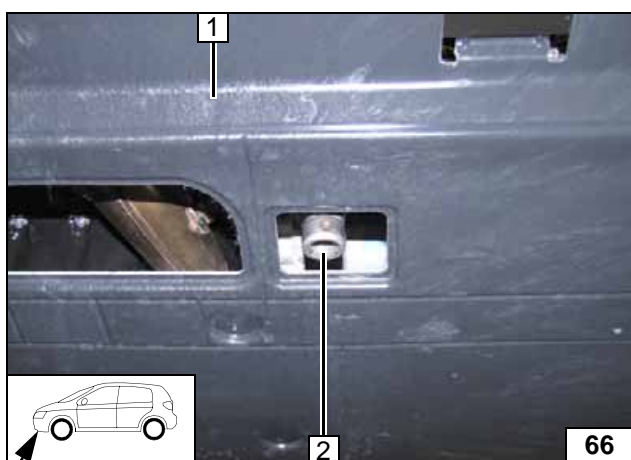

When installing underbody protection **1**, ensure sufficient distance from silencer, adjust if necessary. Align exhaust end section **2** centrally in the recess of underbody protection **1**.

**Aligning  
exhaust  
end section**

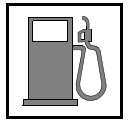

## Template for Fuel Standpipe

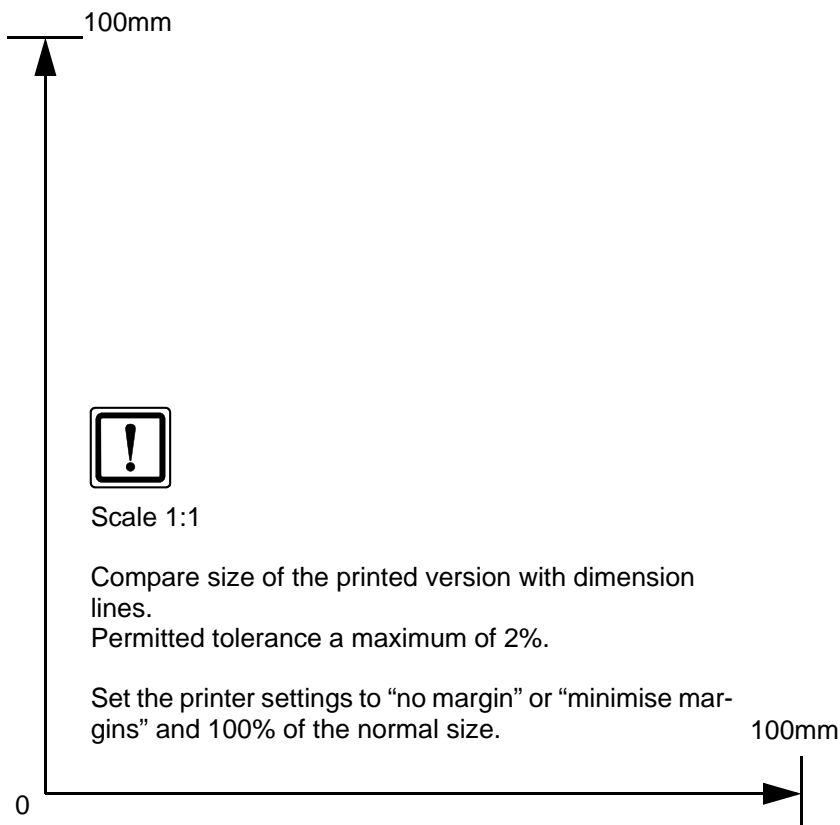



## Operating Instructions for Manual Air-Conditioning

Please remove page and add to the vehicle operating instructions.

### Note:

We recommend matching the heating time to the driving time.

Heating time = driving time

### Example:

For a driving time of approx. 20 min. (in one direction), we recommend not exceeding a switch-on time of 20 min.

Passenger compartment monitoring, if installed, must be deactivated in addition to the vehicle settings for the heating operation.

For instructions on deactivation, please refer to the operating instructions of the vehicle.

Before parking the vehicle, make the following settings:

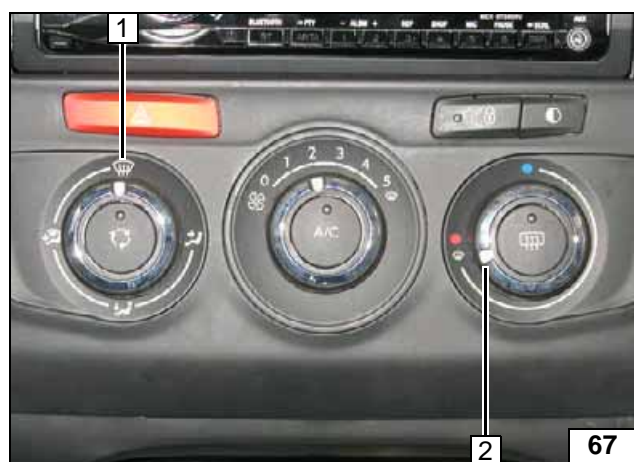

- 1 Air outlet onto windscreen
- 2 Set temperature to "max."



**A/C control panel**

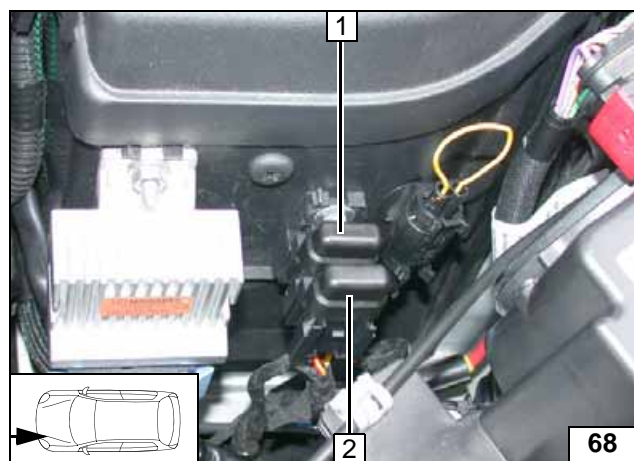

- 1 30A main fuse F2
- 2 20A heater fuse F1

**Fuses of engine compartment**

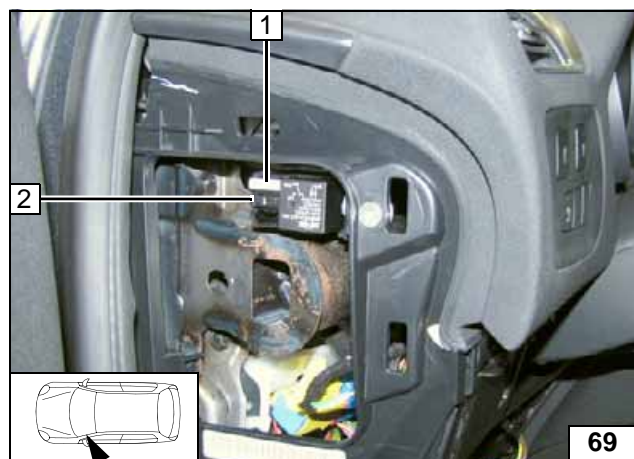

- 1 25A fan fuse F4
- 2 1A fuse of heater control F3

**Fuses of passenger compartment**

## Operating Instructions Automatic Air-Conditioning

Please remove page and add to the vehicle operating instructions.

**Note:**

We recommend matching the heating time to the driving time.

Heating time = driving time

**Example:**

For a driving time of approx. 20 min. (in one direction), we recommend not exceeding a switch-on time of 20 min.

Passenger compartment monitoring, if installed, must be deactivated in addition to the vehicle settings for the heating operation.

For instructions on deactivation, please refer to the operating instructions of the vehicle.

Before parking the vehicle, make the following settings:

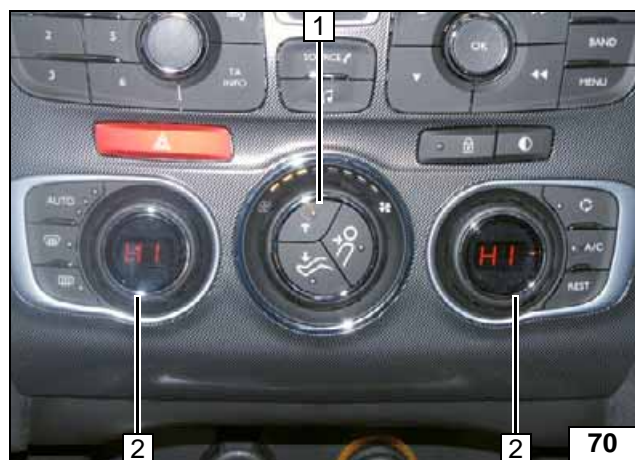

- 1 Air outlet faces upward
- 2 Set temperature on both sides to "HI"



**A/C control panel**

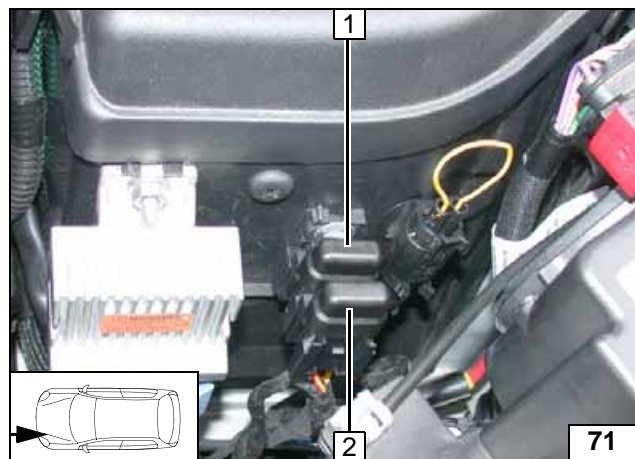

- 1 1A passenger compartment main fuse F2
- 2 20A heater fuse F1

**Fuses of engine compartment**

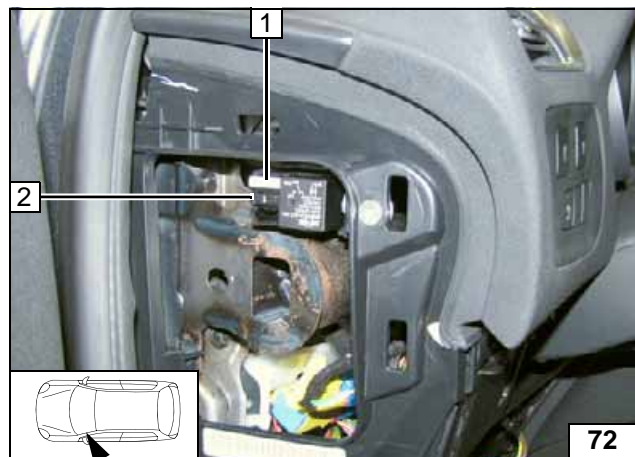

- 1 25A fan fuse F4
- 2 1A fuse of heater control F3

**Fuses of passenger compartment**