

Water Heater



Thermo Top E Parking Heater

00 0003

Thermo Top C Parking Heater

00 0002

Thermo Top P Parking Heater

00 0104

Installation instructions

Citroen C3 Picasso

Gasoline and Diesel
from Model Year 2009
Left-hand drive vehicle
Automatic air-conditioning



WARNING!

Hazard warning:

Incorrect installation or repair of Webasto heating systems may cause a fire or result in the emission of carbon monoxide, which can be fatal. Serious or fatal injuries can be caused as a result.



Specialist company training, technical documentation, specialised tools and equipment are required to install and repair Webasto heating and cooling systems. Only original Webasto parts must be used. For this, also see the catalog of air and water heater accessories from Webasto.

NEVER attempt to install or repair Webasto heating or cooling systems if you have not successfully completed the company training and thereby acquired the required technical skills, or if you do not have access to the required technical documentation, tools and equipment needed to carry out correct installation and repairs.

ALWAYS follow all Webasto installation and repair instructions and observe all warnings.

Webasto does not accept any liability for defects and damage that are attributable to installation by untrained staff.

Table of Contents

Validity	2	Preparing heater	12
Heater/Installation Kit	3	Preparing installation location	12
Foreword	3	Installing heater	13
General Instructions	3	Gasoline coolant circuit	14
Special Tools	3	Diesel coolant circuit	17
Explanatory Notes on Document	4	Combustion air	21
Preliminary Work	5	Fuel	22
Heater installation location	5	Exhaust gas	25
Preparing electrical system	6	Final Work	26
Electrical system	7	Template for Gasoline Fuel Standpipe	27
Fan controller	8	Template for Diesel fuel standpipe	28
Remote option (Telestart)	11	Operating Instructions for End Customer	29

Validity

Manufacturer	Model	Type	EG-BE No./ABE
Citroen	C3 Picasso	SH****	e2 * 2001/116 * 0371 * ...

Engine type	Engine model	Output in kW	Displacement in cm ³
8FSC	Gasoline	70	1397
5FWO	Gasoline	88	1598
9 Hz	Diesel	80	1560

Vehicle and engine types, equipment variants and national specifications not listed in these installation instructions have not been tested. However, installation according to these installation instructions may be possible.

The installation location of a digital timer and summer/winter switch should be confirmed with the end customer before installation.

Heater/Installation Kit

Quantity	Description	Order No.:
1	Retail accessories <i>Thermo Top E / C / P</i>	See price list
1	Installation kit Citroen C3 Picasso 2009 Gasoline and Diesel	1314917C
1	Heater control	See price list

Heater recommended for the respective vehicle class:

Vehicle	Heater
Compact car	Thermo Top E
Mid-size car, station wagon	Thermo Top C
Full-size car, van, offroader	Thermo Top P

The selection of the heater is based on the passenger compartment size of the vehicle and the level of comfort required by the customer!



Foreword

These installation instructions apply to the vehicles Citroen C3 Picasso Gasoline and Diesel - for validity, see page 2 - from model year 2009 and later, assuming technical modifications to the vehicle do not affect installation, any liability claims excluded. Depending on the vehicle version and equipment, modifications may be necessary during installation with respect to these installation instructions.

However, the stipulations in the "installation instructions" and "operating and maintenance instructions" for the *Thermo Top C/P/E* must always be observed.

The corresponding rules of technology and any information from the vehicle manufacturer should be observed during the installation work.

General Instructions

Installation should be carried out according to the general, standard rules of technology. Unless specified otherwise, fasten hoses, lines and wiring harnesses to original vehicle lines and wiring harnesses using cable ties.

Sharp edges must be provided with rub protection (cut-open fuel hose)!

Spray unfinished body areas, e.g. drilled holes, with anti-corrosion wax (Tectyl 100K, Order No. 111329).

Special Tools

- Torque wrench for 2.0 - 10 Nm
- Hose clamping pliers
- Metric thread-setter kit

Explanatory Notes on Document

To provide you with a quick overview of the individual working steps, you will find an identification mark on the outside top right corner of the page in question.

Mechanical system

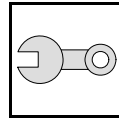

Electrical system

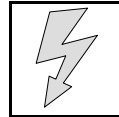

Water

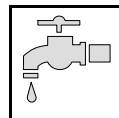

Fuel

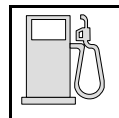

Exhaust gas

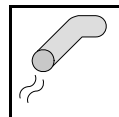

Combustion air

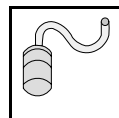

Software

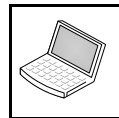

Special features are highlighted using the following symbols:



Specific risk of injury or fatal accidents.



Specific risk of damage to components.



Specific risk of fire or explosion.



Reference to general installation instructions of Webasto components or to the manufacturer's vehicle-specific documents.



Reference to a special technical feature.



The arrow in the vehicle icon indicates the position on the vehicle and the viewing angle.

All dimensions are in mm!

Tightening torque of hose clamps = 2.0 + 0.5 Nm!

Tightening torque of Ejet screws, Ejet studs = 10 Nm!

Preliminary Work

WARNING!

- Open the fuel tank cap and vent the fuel tank.
- Close the tank cap again.
- Disconnect the battery "earth" or "ground" connection.
- Depressurize the cooling system.
- Copy the factory number from the original type label to the duplicate type label.
- Remove years that do not apply from the duplicate label.
- Attach the duplicate label (type label) in the appropriate place.
- Remove the battery completely.
- Remove the air filter together with the intake hose
- Open the fuel tank cap and vent the fuel tank.
- Close the tank cap again.
- Remove the left-hand underride protection.
- Remove the left rear seat cushion and backrest.
- Open the fuel sender service lid.
- Remove the fuel-tank sending unit in accordance with the manufacturer's instructions.
- Remove the wheel/A/C control panel in accordance with the manufacturer's instructions.
- Remove the trim of the centre tunnel in the left-hand footwell
- Remove the lower instrument panel trim on the left.
- Remove the A/C control panel.

Remove page 29 "Operating Instructions for End Customer" and add to the vehicle operating instructions.

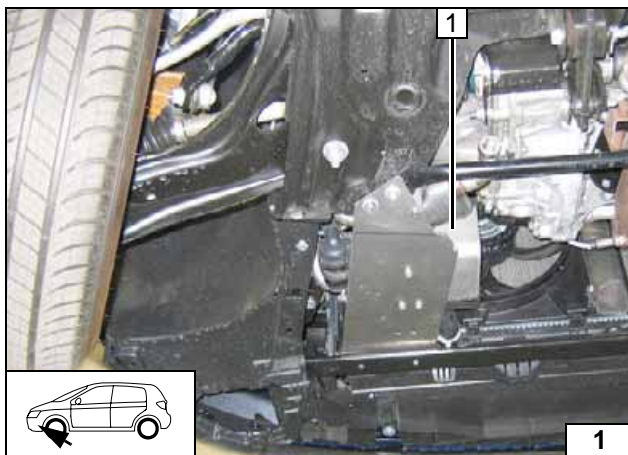

Heater installation location

1 Heater

Installation location



Preparing electrical system

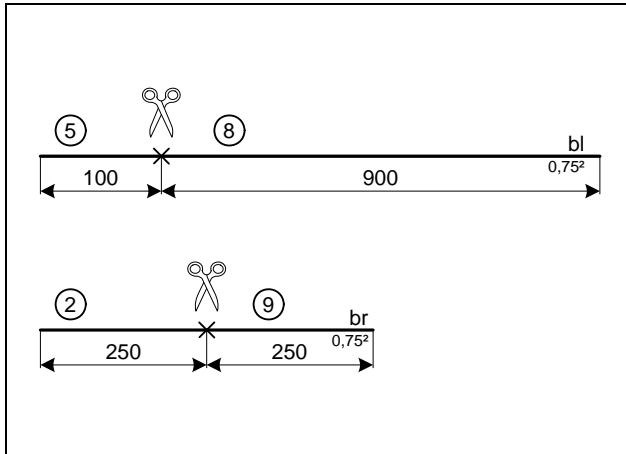

Cutting wires to length

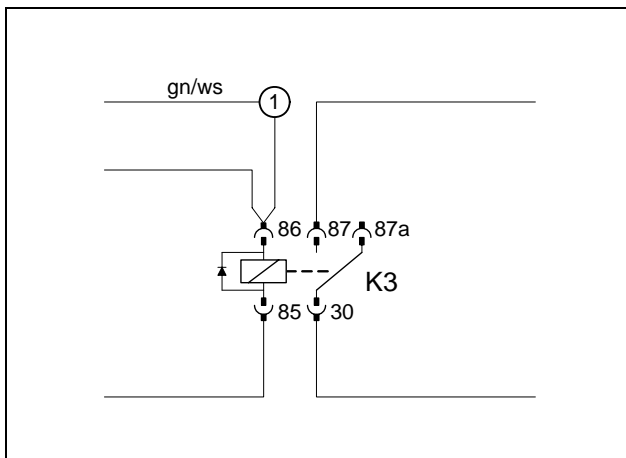

Produce connections as shown in wiring diagram. Remove 4² red (rt) wire from K3/87a and discard. Install wire section 1 in protective sleeving provided.



- ① 2,000 mm long 0.75² green/white (gn/ws) wire

Preparing K3 relay

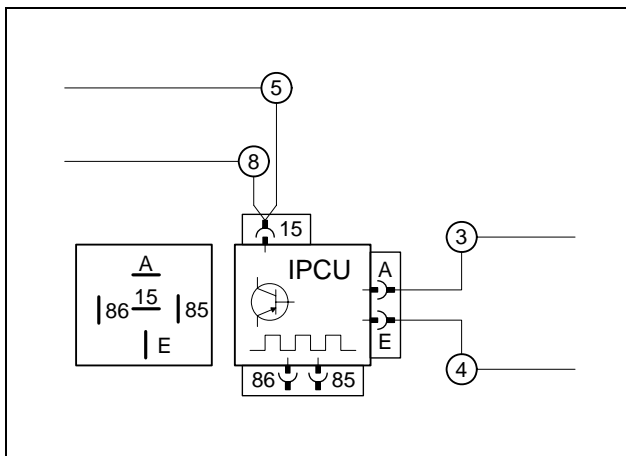

Connect wires to IPCU.

IPCU view on contact side!

Insert blue (bl) wire 5 and 8 in IPCU/15. Install wire section 8 in protective sleeving provided.



- ③ 500 mm long 0.75² black (sw) wire
- ④ 500 mm long 0.75² red (rt) wire

Preassembling IPCU

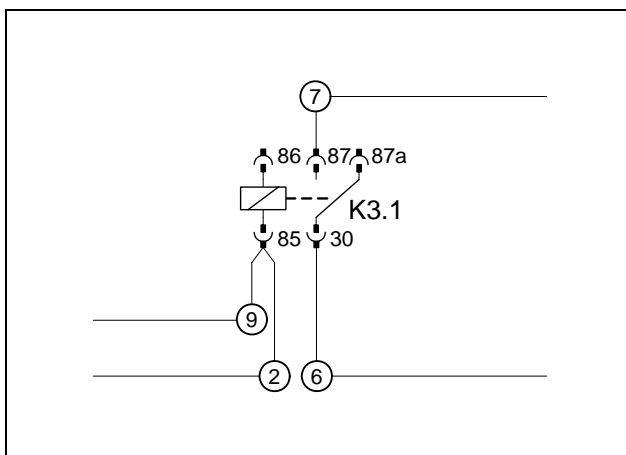

Produce connections as shown in wiring diagram.

- ⑥ 500 mm long 0.75² black (sw) wire
- ⑦ 500 mm long 0.75² red (rt) wire



Preparing additional relay K3.1



Electrical system

Wiring harness pass through

- 1 18 mm dia. hole, included protective rubber plug

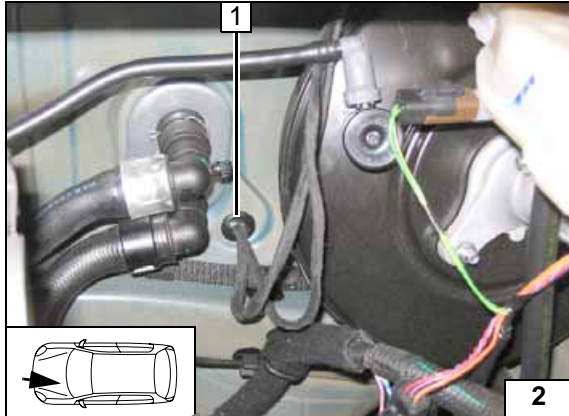

Summer/winter switch option

- 1 Summer/winter switch, drilled hole 12 mm dia.

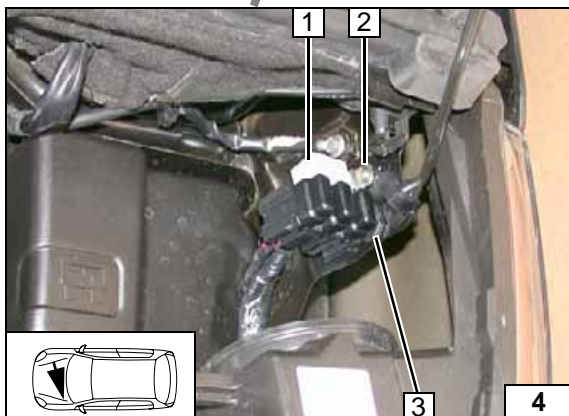
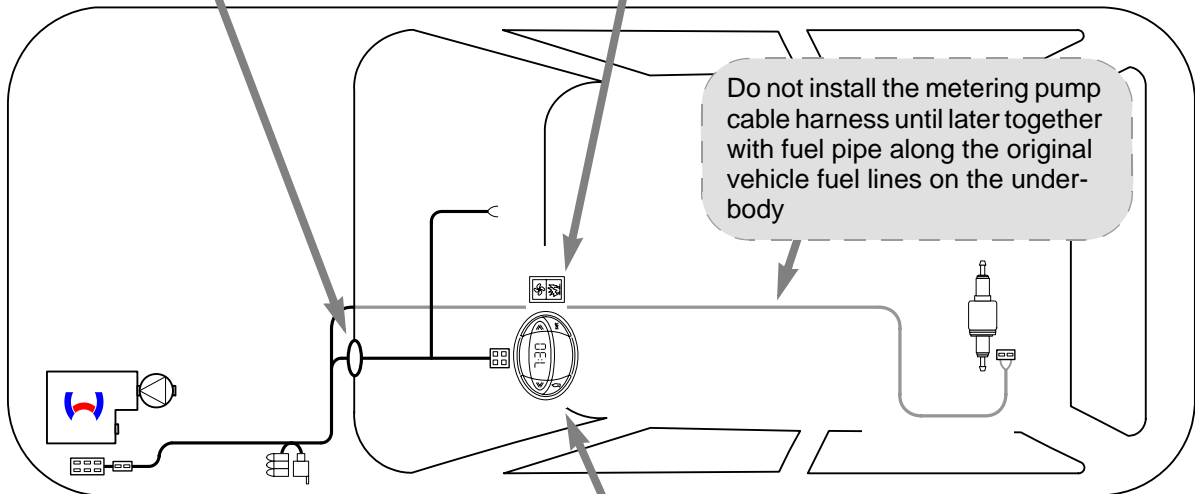

Fuse holder, K3 relay

- 1 K3 relay
- 2 4.5 mm dia. hole; 5.5x13 mm bolt
- 3 4.5 mm dia. hole; 5.5x13 bolt; retaining plate of fuse holder

Digital timer

- 1 Digital timer



Wiring harness installation diagram



Fan controller

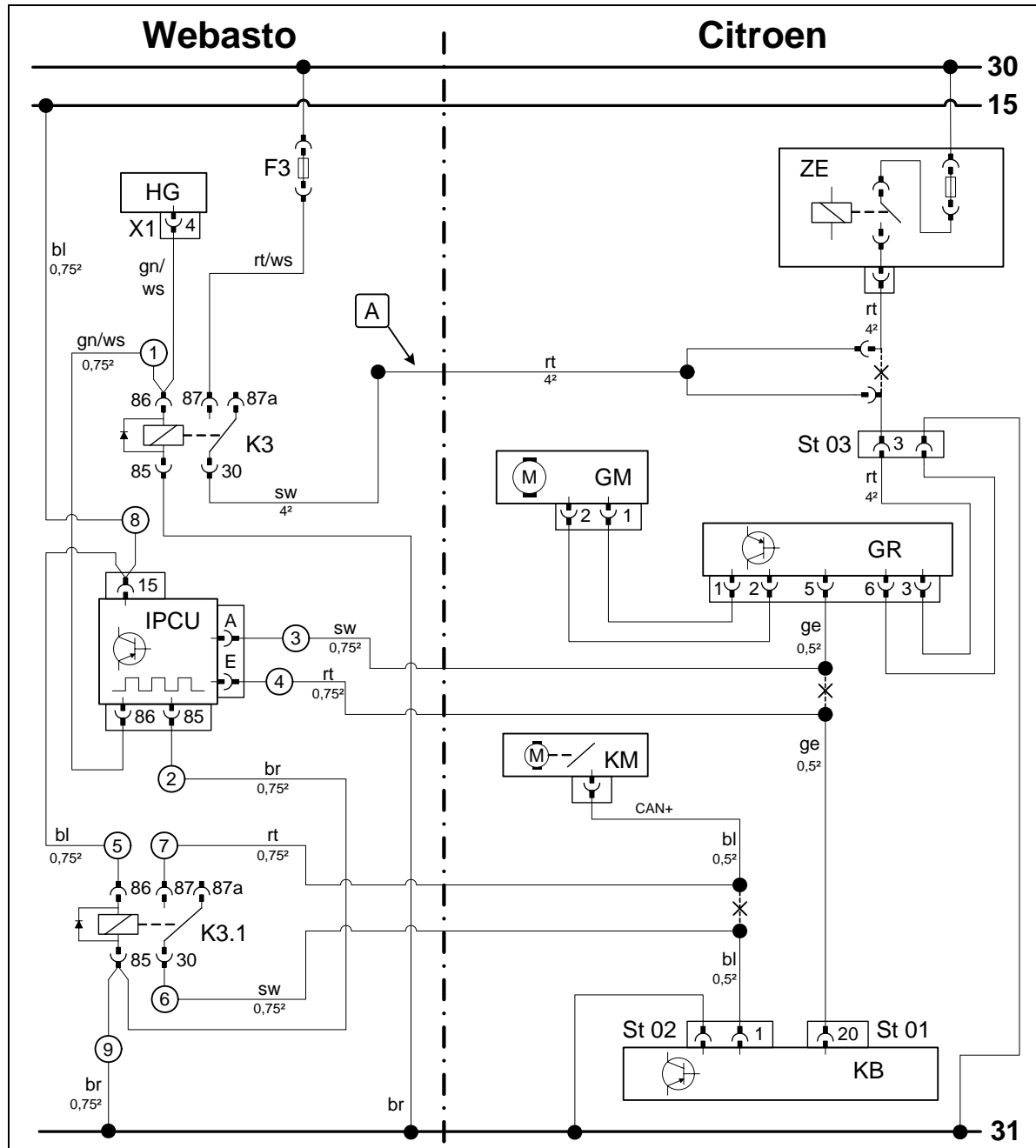

Wiring diagram

Webasto components		Vehicle components		Colours and symbols	
HG	TT-C/E/P heater	GM	Fan motor	rt	red
X1	6-pin heater connector	ZE	Central electrical box	ws	white
F3	25 A fuse	GR	Fan controller	sw	black
K3	Fan relay	KB	A/C control panel	br	brown
K3.1	Additional relay	St 01	20-pin connector KB	gn	green
IPCU	Pulse width modulator	St 02	6-pin connector KB	bl	blue
a	Adapter wiring harness	KM	Control unit of flap motor	ge	yellow
IPCU adjustment values:		St 03	6-pin connector		
Duty cycle: 70%					
Frequency: 400 Hz					
Voltage: 12 V				X	Cutting point
Function: Low-side					Wiring colours may vary.

Legends

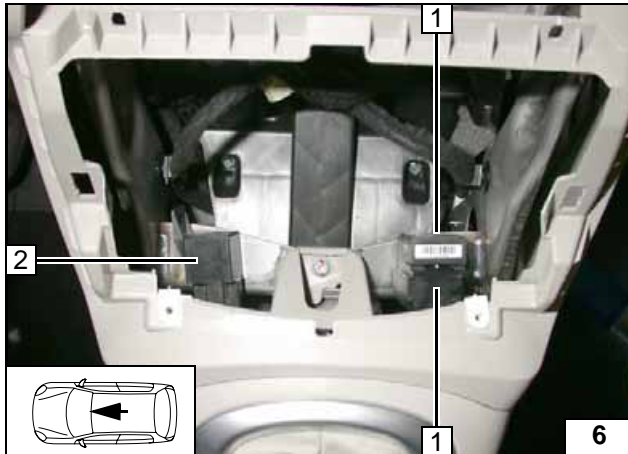

Insert green/white (gn/ws) wire ① in IPCU/86.
 Insert brown (br) wire ② in IPCU/85.
 Insert blue (bl) wire ⑤ in K3.1/86.
 Produce connections as shown in wiring diagram. Fasten IPCU 1 and K3.1 relay 2 with adhesive tape.



Fastening IPCU and K3.1 relay

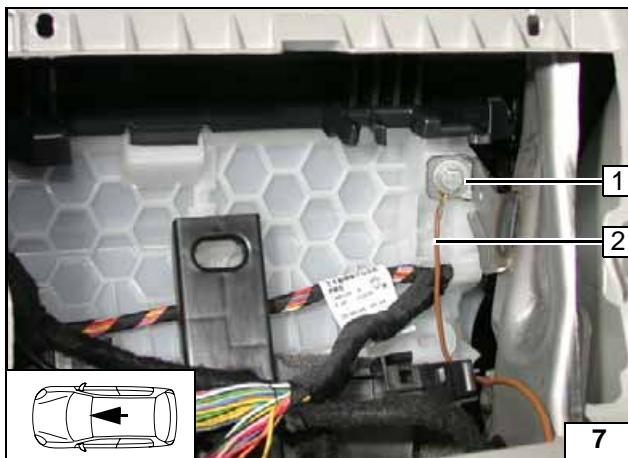

Produce connections as shown in wiring diagram.

- 1 Original vehicle bolt
- 2 Brown (br) wire ⑨ K3.1/85



Ground connection of IPCU and K3.1 relay

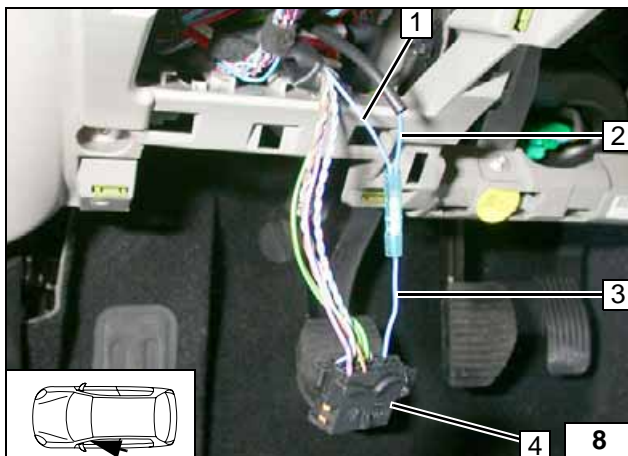

Connection on 18-pin connector of OBD 4
 Produce connections as shown in wiring diagram.

- 1 Blue (bl) wire of Terminal 15
- 2 Blue (bl) wire ⑧ of IPCU/15
- 3 Blue (bl) wire of 18-pin connector, Pin 1



Connection of IPCU Terminal 15

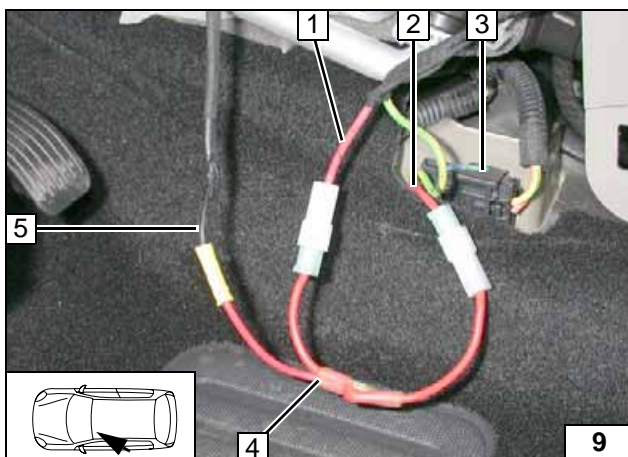

Connection to 6-pin connector 3 from wiring harness of fan controller.
 Produce connections as shown in wiring diagram.

- 1 Red (rt) wire of fan relay ZE
- 2 Red (rt) wire of 6-pin connector St 03, Pin 3
- 4 Y-adapter wiring harness
- 5 Black (sw) wire from K3/30



Connecting fan controller

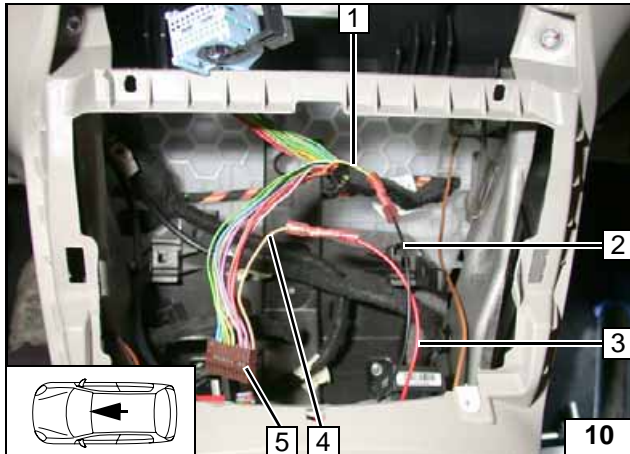
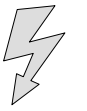

Connection on 20-pin connector **5** from A/C control panel (connector dismantled).
Produce connections as shown in wiring diagram.

- 1 Yellow (ge) wire of fan controller
- 2 Black (sw) wire ③ of IPCU/A
- 3 Red (rt) wire ④ of IPCU/E
- 4 Yellow (ge) wire of 20-pin connector, Pin 20



**Connect-
ing A/C
control
panel**

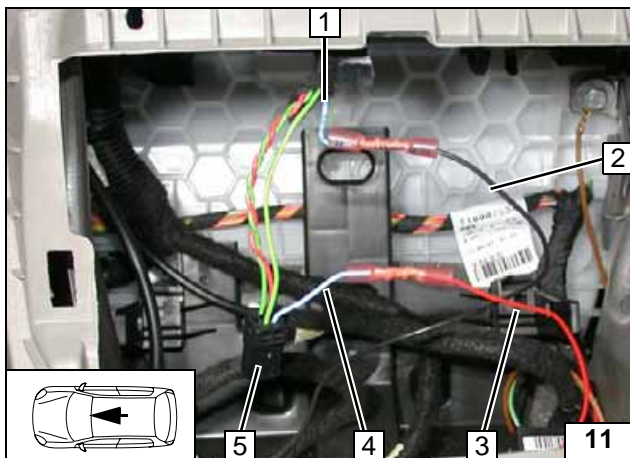

Connection to 6-pin connector **5** from A/C control unit.
Produce connections as shown in wiring diagram.

- 1 Blue (bl) wire of flap motor control unit (CAN+-line)
- 2 Black (sw) wire ⑥ of K3.1/30
- 3 Red (rt) wire ⑦ of K3.1/87
- 4 Blue (bl) wire of 6-pin connector, Pin1



**Connec-
tion of flap
motor**

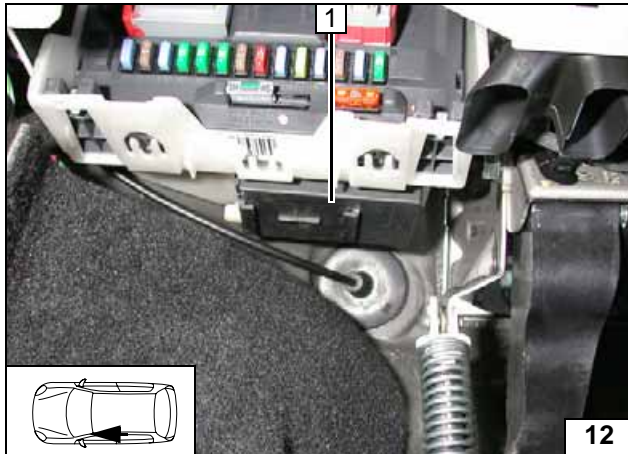

Remote option (Telestart)

Fasten receiver 1 with adhesive tape.



Installing receiver

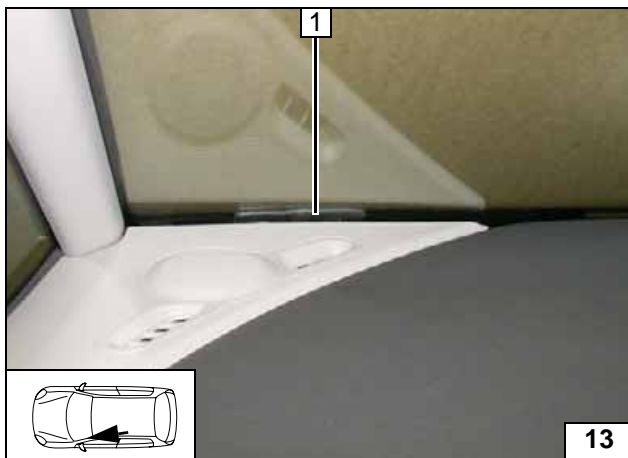

1 Antenna

Installing antenna

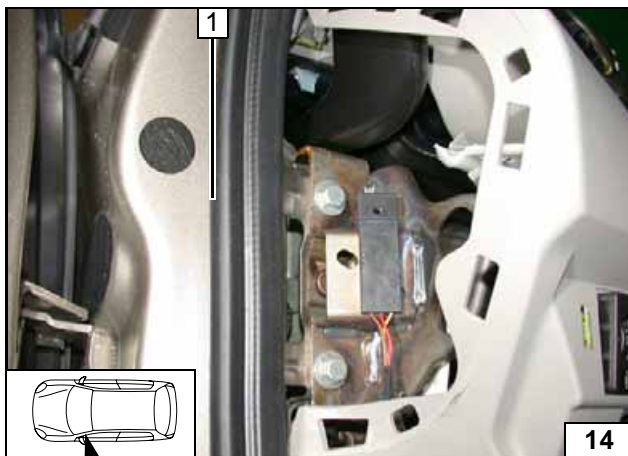

Temperature sensor HTM100

Fasten temperature sensor 1 with adhesive tape.



Installing temperature sensor

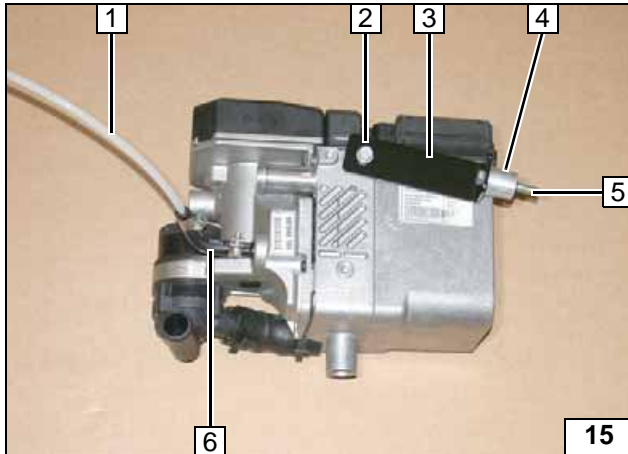
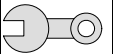

Preparing heater

- 1 Fuel line
- 2 Ejet screw
- 3 Strut
- 4 20 mm spacer sleeve
- 5 M6x40 bolt, pin lock
- 6 90° moulded hose, hose clamp
10 mm dia [2x]

Preparing heater

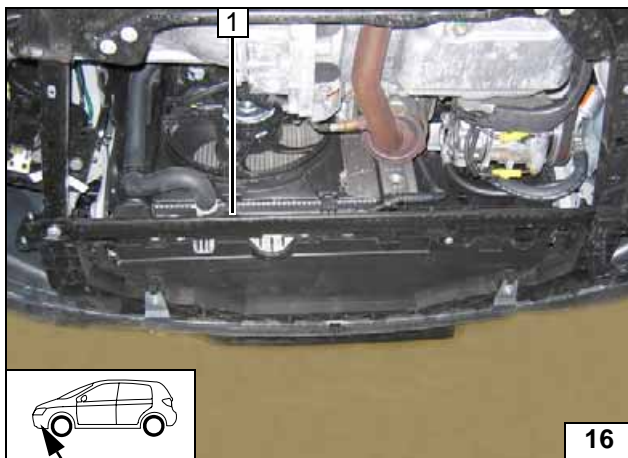

Preparing installation location

- 1 Remove original vehicle strut

Removing strut

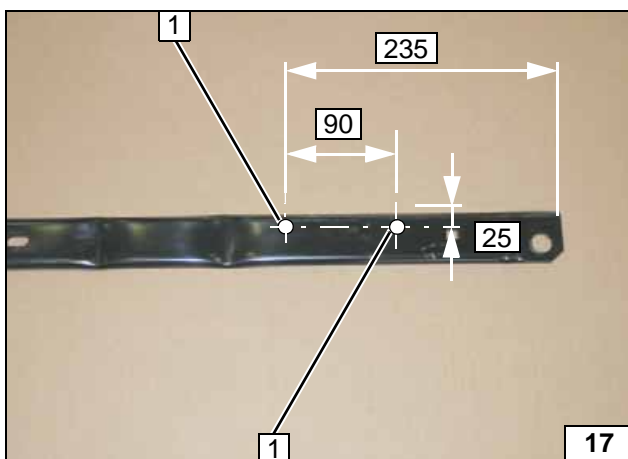

Copy hole pattern as shown and drill 9.1 mm dia. holes [2x] in strut at position 1.



Copying hole pattern

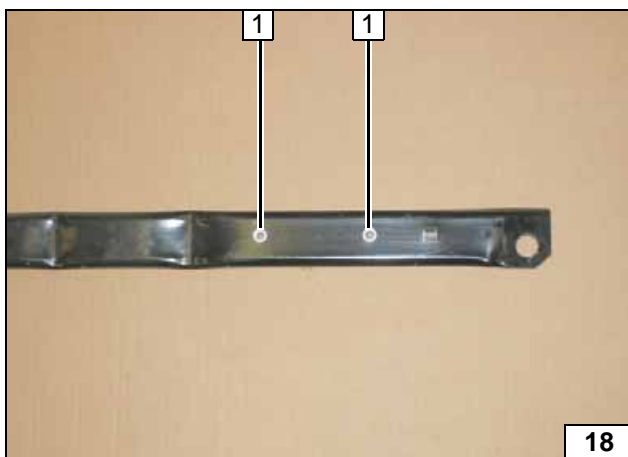

- 1 M6 rivet nut [2x]

Installing rivet nut

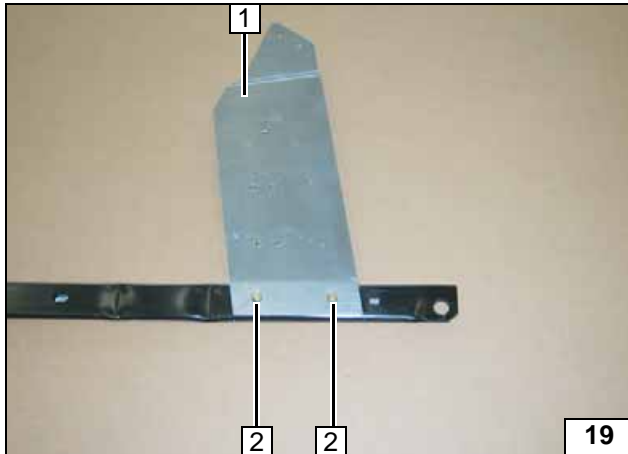
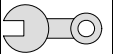

- 1 Loosely mount bracket
- 2 M6x16 bolt [2x], spring lockwasher [2x]

Installing bracket

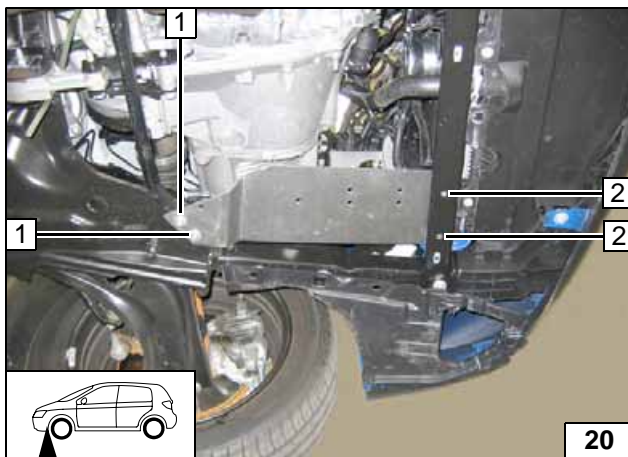

- 1 Original vehicle bolt [2x]
- 2 Tighten M6x16 bolt with spring lockwasher [2x]

Installing bracket

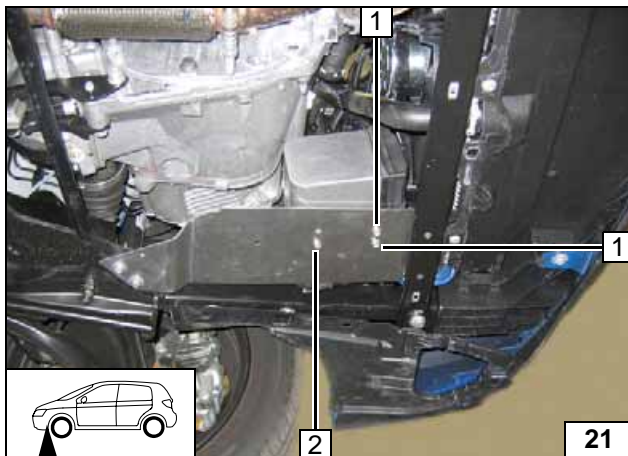

Installing heater

Insert two washers between heater and bracket at Position 2.

- 1 E-jot screw [2x]
- 2 E-jot screw, washer [2x]



Installing heater

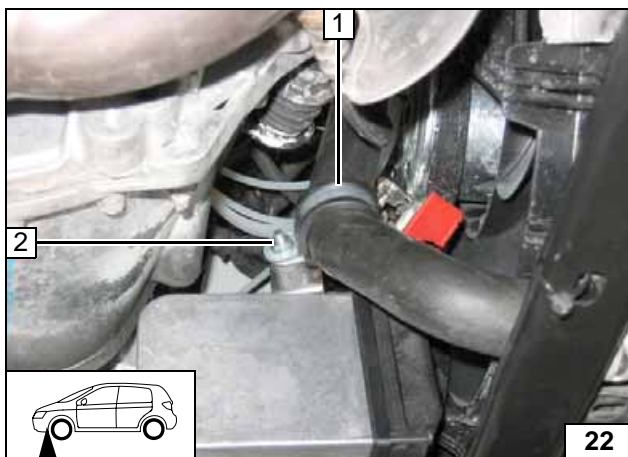

Rubber-coated pipe clamp at Position 1 for 1.4l gasoline = dia 48, for 1.6l gasoline+diesel = dia 34!

- 2 Flanged nut on prepared bolt



Installing heater

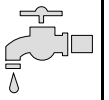

Gasoline coolant circuit

WARNING!

Any coolant running off should be collected using an appropriate container! Route coolant hoses kink-free! Unless specified otherwise, always fasten using cable ties. Position clamps so that no other hose can be damaged! When installing the hoses, the heater must be filled with coolant. The connection should be "inline" based on the following diagram:

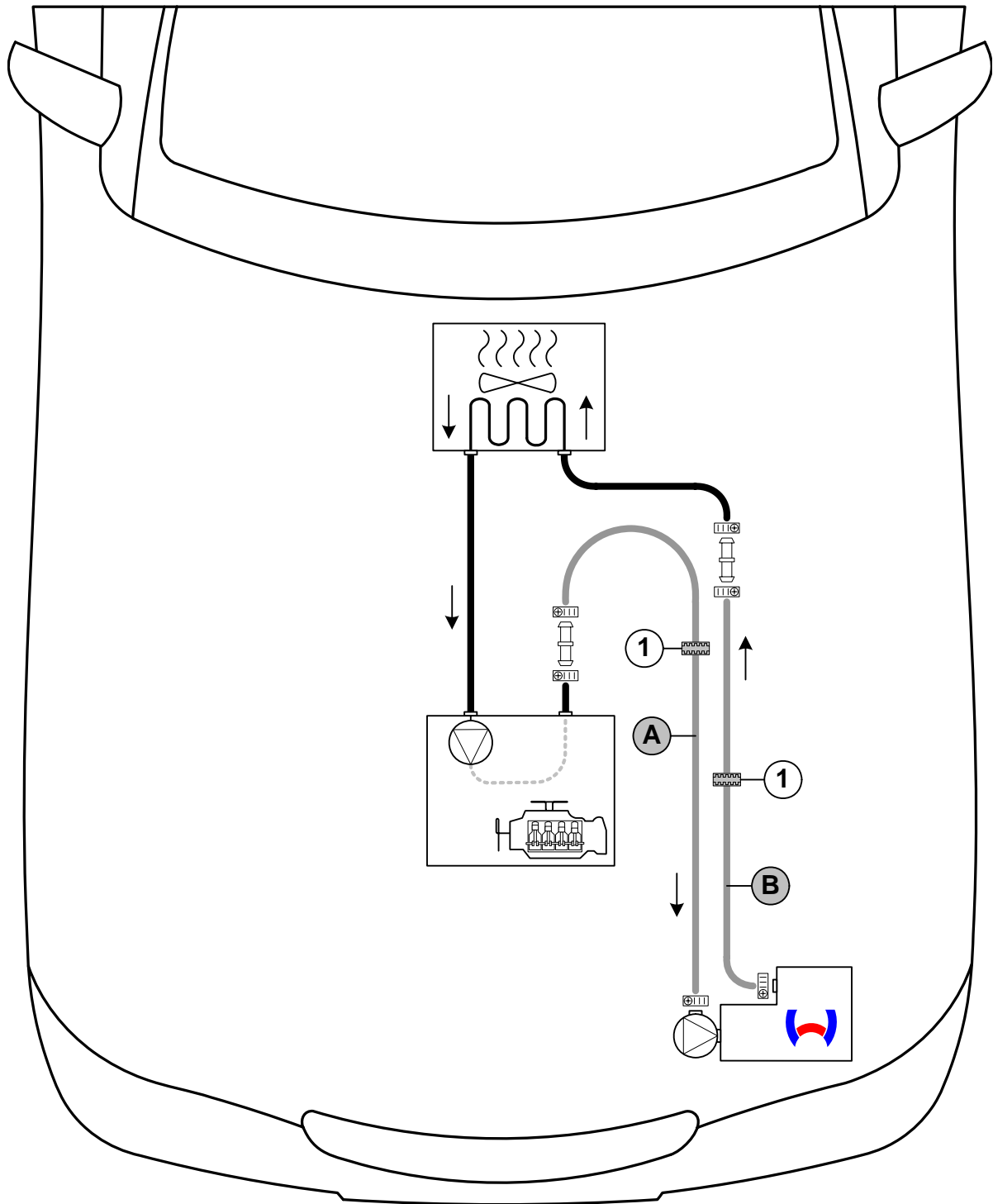

Hose routing diagram

All connecting pipes (□□) = 18x20 mm dia. All hose clamps (⊕III) = 20-27 mm dia.!
 1 = Black (sw) rubber isolator [2x]!



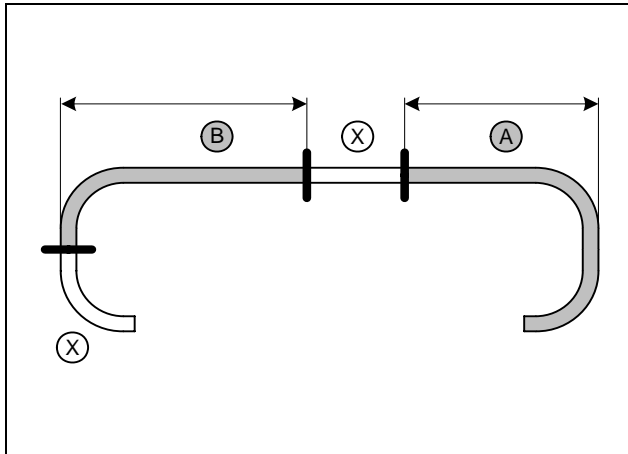

Discard section X.

a = 660
b = 600



Cutting coolant hoses to length

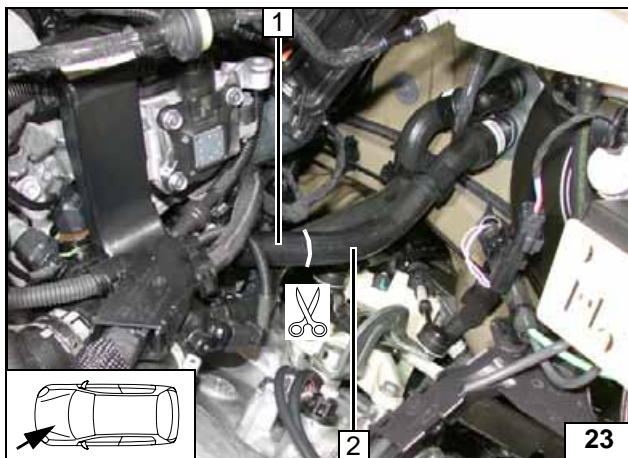

1 Engine-outlet hose section
2 Hose section of heat exchanger inlet

Cutting point

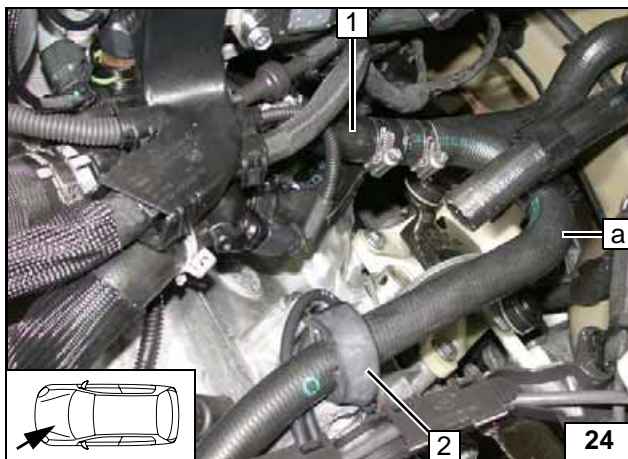

Push black (sw) rubber isolator 2 onto hose A.

1 Hose of engine outlet



Connecting engine outlet

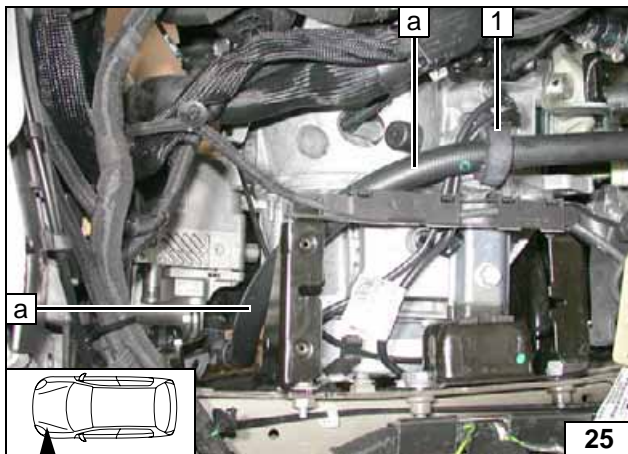

1 Position black (sw) rubber isolator

Routing in engine compartment

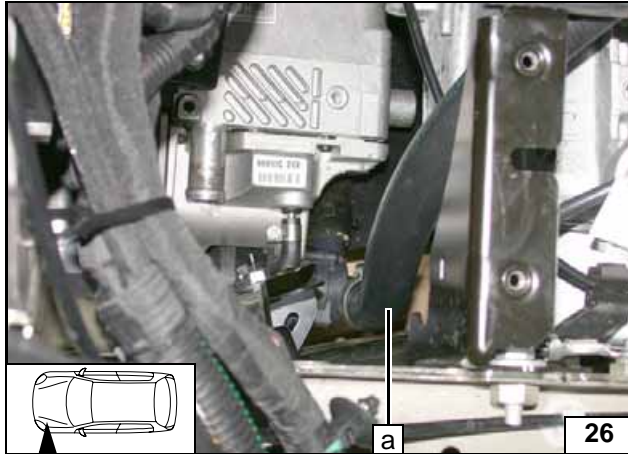

Connect-
ing heater
inlet

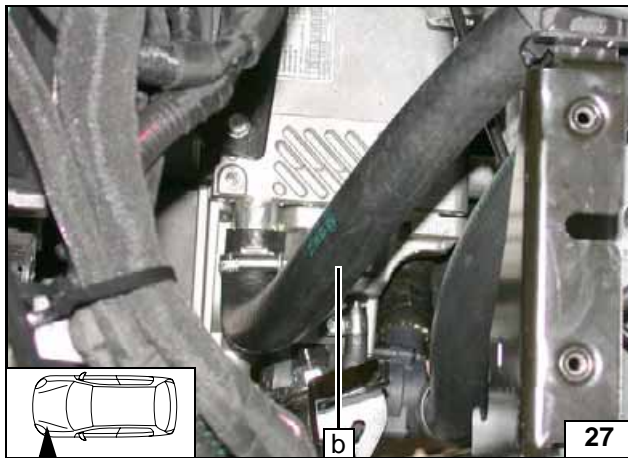

Connect-
ing heater
outlet

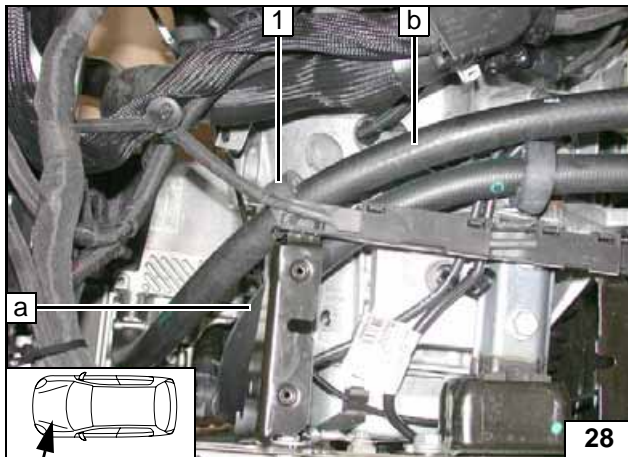

Slide black (sw) rubber isolator 1 onto hose B and position.

Routing in
engine
compart-
ment

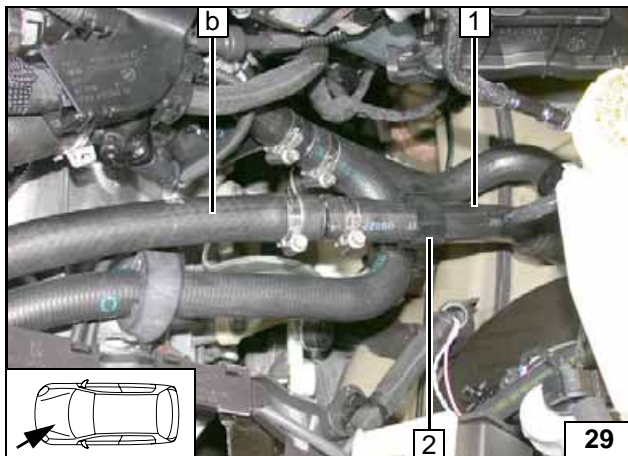

Ensure sufficient distance to neighbouring components.

- 1 Hose on heat exchanger inlet
- 2 Original vehicle spacer bracket



Connect-
ing heat
exchanger
inlet

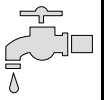

Diesel coolant circuit

WARNING!

Any coolant running off should be collected using an appropriate container! Route coolant hoses kink-free! Unless specified otherwise, always fasten using cable ties. Position clamps so that no other hose can be damaged! When installing the hoses, the heater must be filled with coolant. The connection should be "inline" based on the following diagram:

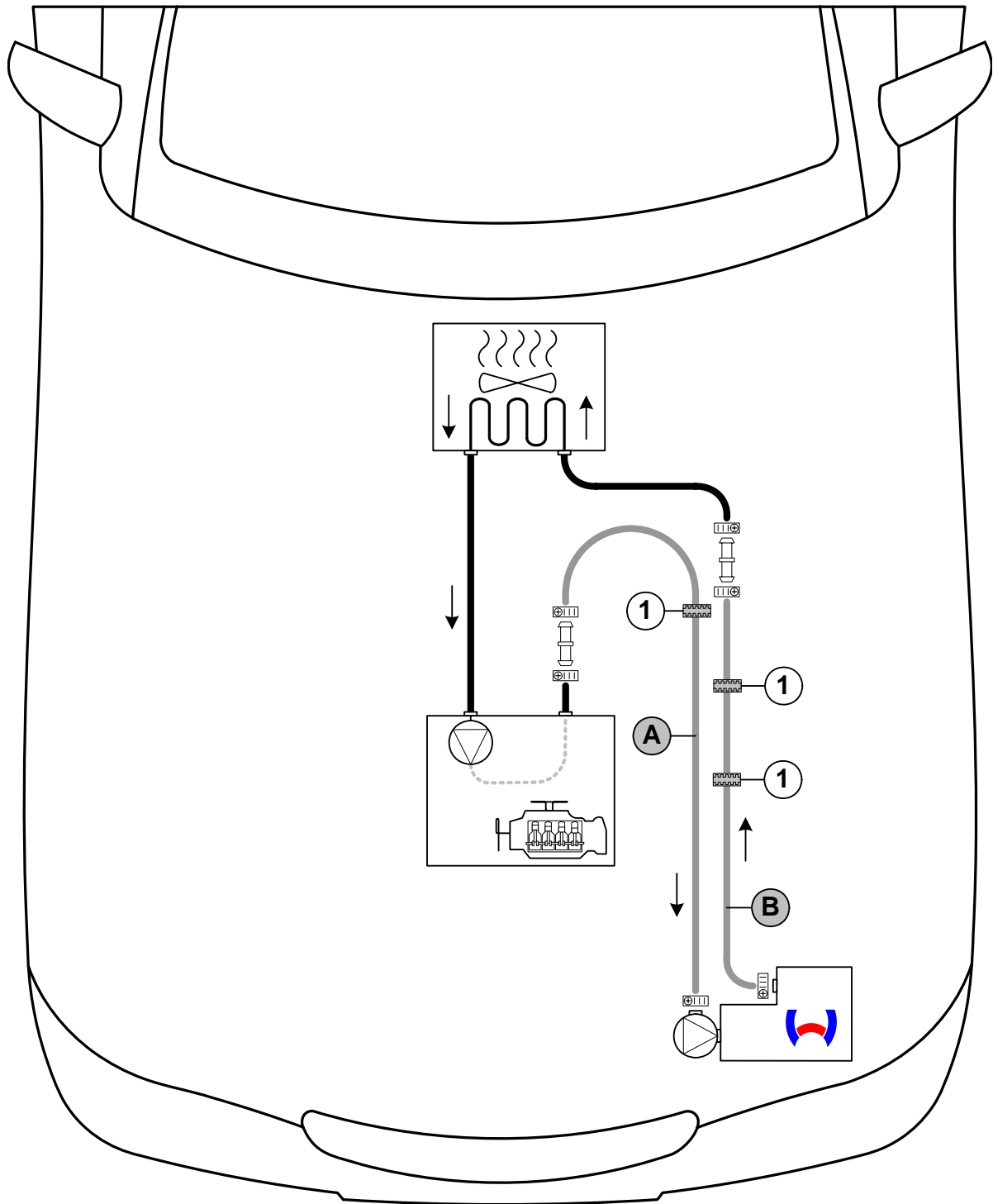

Hose routing diagram

All connecting pipes (□□) = 18x20 mm dia. All hose clamps (⊕|||) = 20-27 mm dia.!
 1 = Black (sw) rubber isolator (▤▤▤) [3x]!



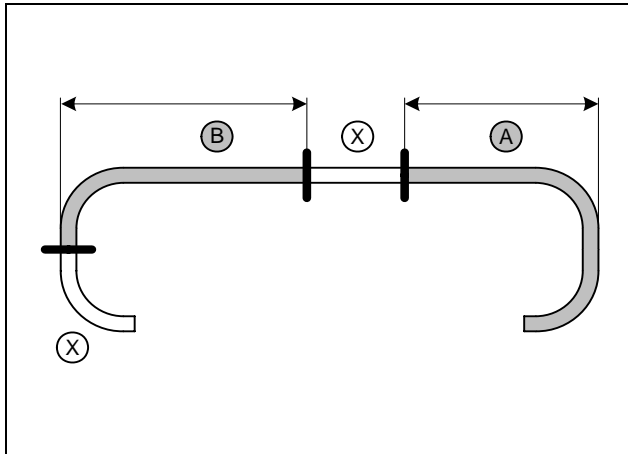
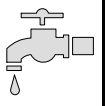

Discard section X.

a = 660
b = 560



Cutting coolant hoses to length

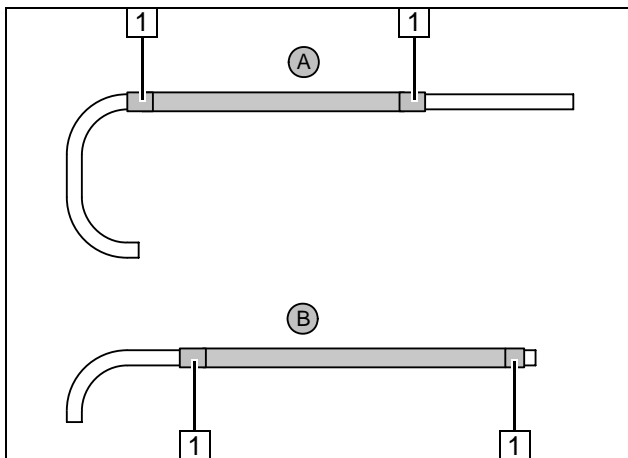

Push braided protection hoses onto hose A and B and cut to length.
Cut heat shrink plastic tubing to length.

1 50 mm long heat shrink plastic tubing [4x]



Preparing coolant hoses

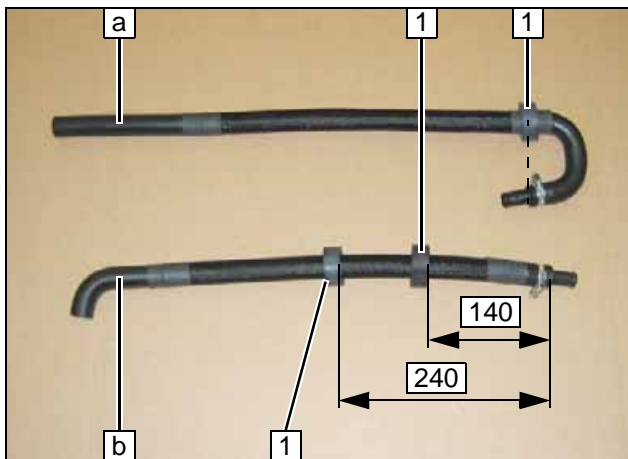

Slide black (sw) rubber isolator 1 [3x] on to hoses.



Preparing coolant hoses

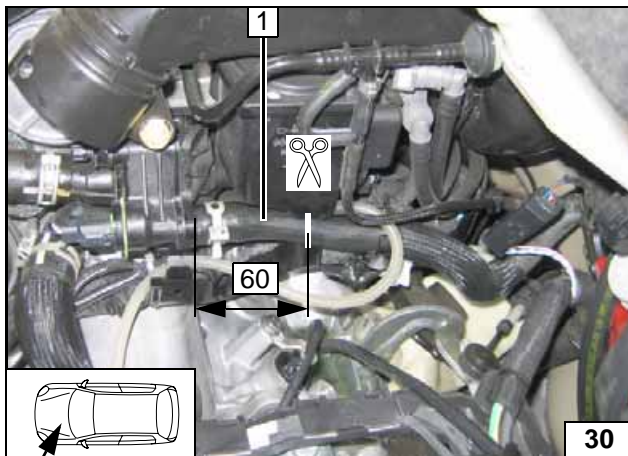

Cut off hose on engine outlet/heat exchanger inlet 1 at marking.



Cutting point

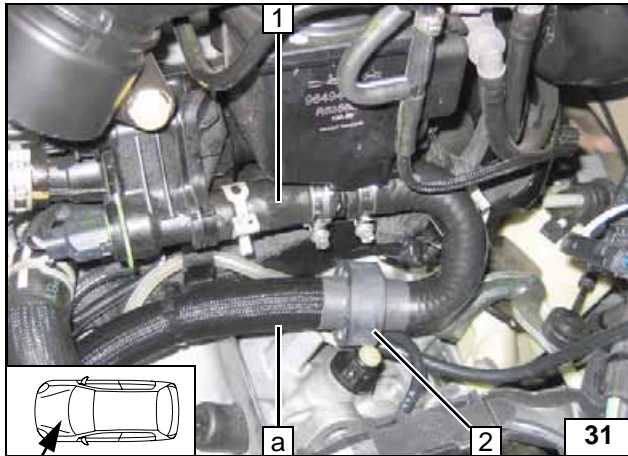
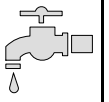

Align black (sw) rubber isolator 2.

1 Hose of engine outlet



Connect-
ing engine
outlet

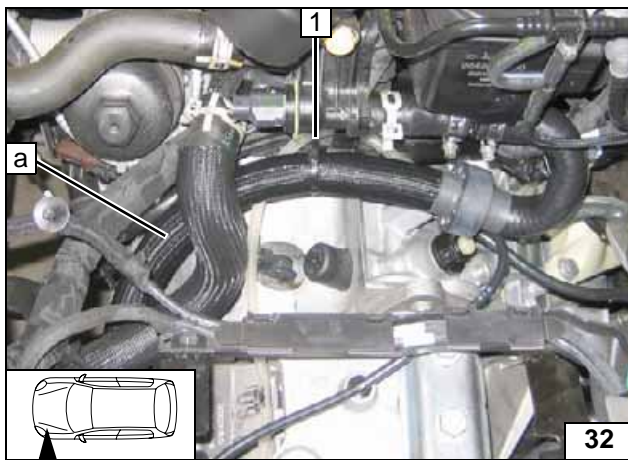

Cable tie 1 on existing tab.



Routing in
engine
compart-
ment

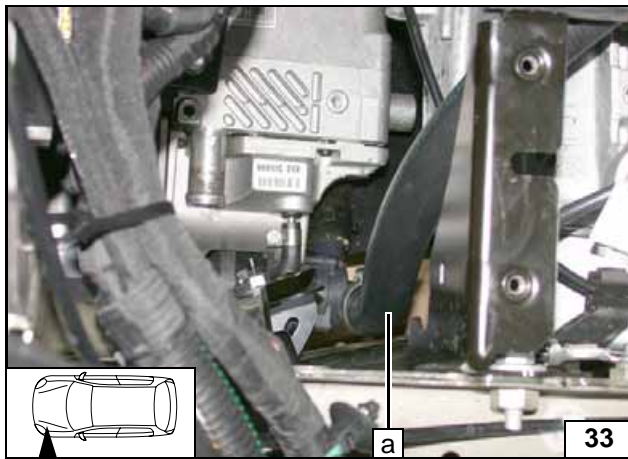

Connect-
ing heater
inlet

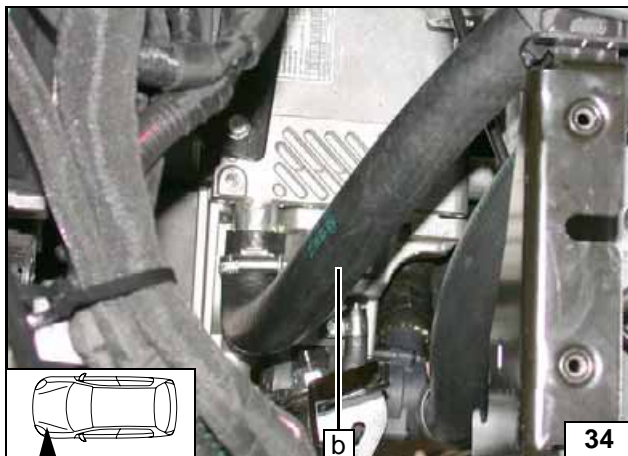

Connect-
ing heater
outlet

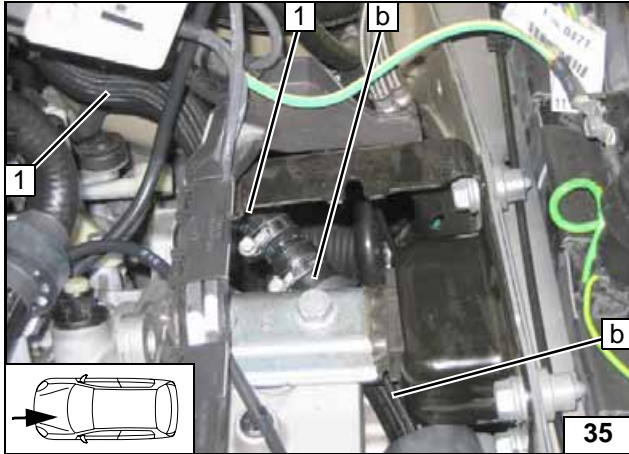

1 Hose on heat exchanger inlet

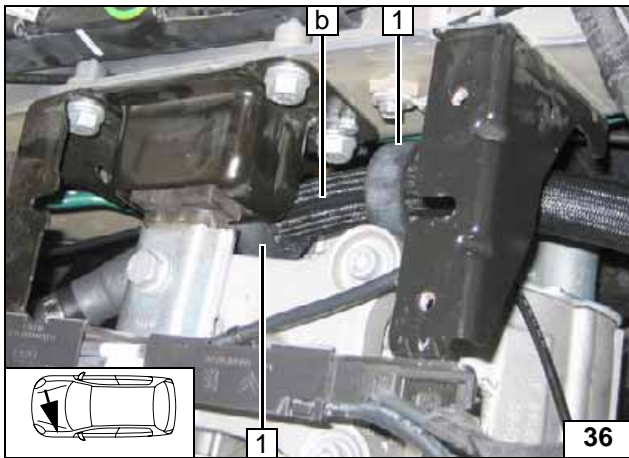

Position black (sw) rubber isolator **1** [2x].
Ensure sufficient distance to neighbouring components.

**Connect-
ing heat
exchanger
inlet**



**Routing in
engine
compart-
ment**

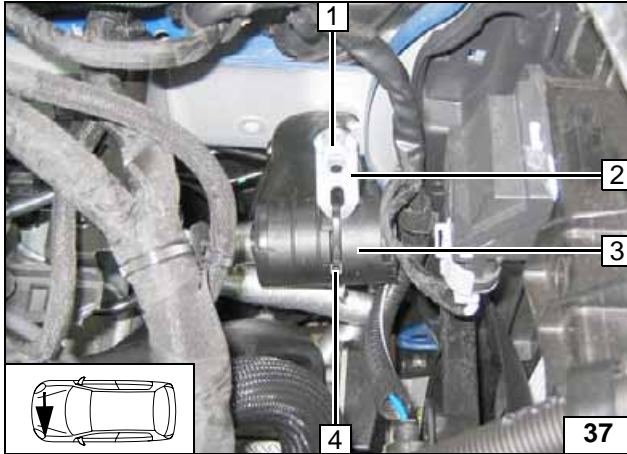
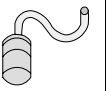

Combustion air

- 1 Original vehicle bolt
- 2 Angle bracket
- 3 Muffler
- 4 Cable tie



Installing muffler

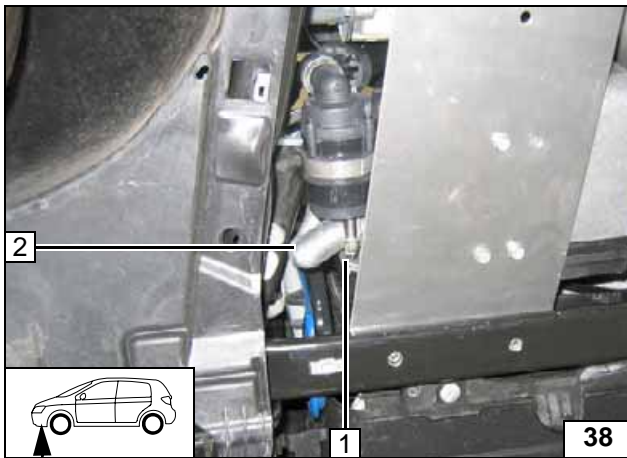

- 1 27 mm dia. clamp
- 2 Combustion air pipe

Installing combustion air pipe

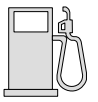

Fuel

CAUTION!

Open the vehicle's fuel tank cap, ventilate the tank and then re-close the tank lock.

Catch any fuel running off with an appropriate container.

Install fuel line and metering-pump wiring harness so that they are protected against stone impact. Unless specified otherwise, always fasten using cable ties.

Mount the fuel line and wiring harness with rub protection on sharp edges.

WARNING!

The fuel line and wiring harness are routed to the metering pump in as shown in the wiring harness routing diagram.



Route fuel line and wiring harness of metering pump 1 along original vehicle brake lines to installation location of metering pump.

Installing lines

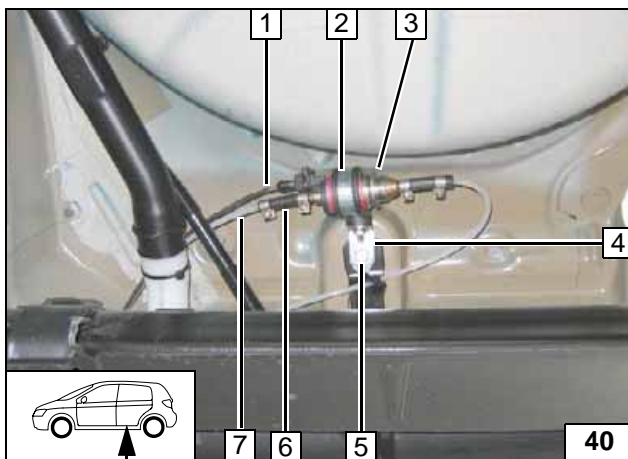

- 1 Metering pump wiring harness
- 2 Rubber-coated p-clamp, silent block, flanged nut [2x]
- 3 Metering pump
- 4 Angle bracket
- 5 Original vehicle bolt
- 6 Hose section, 10 mm dia. hose clamp [2x]
- 7 Fuel line from heater



Installation location of metering pump

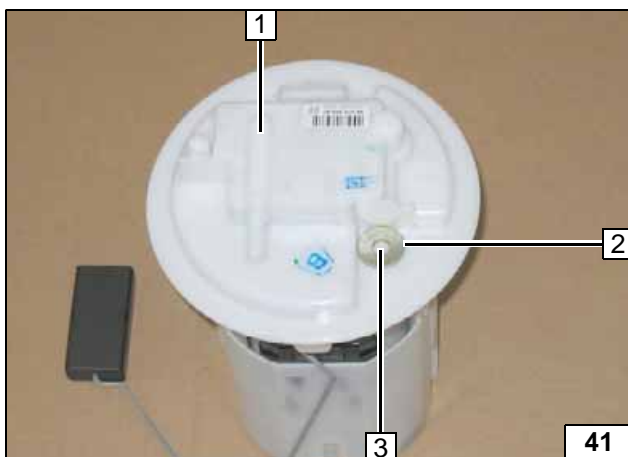

Gasoline

Remove fuel-tank sending unit 1 in accordance with manufacturer's specifications.

- 2 Large diameter washer
- 3 Copy hole pattern, 6 mm dia. hole



Removing fuel

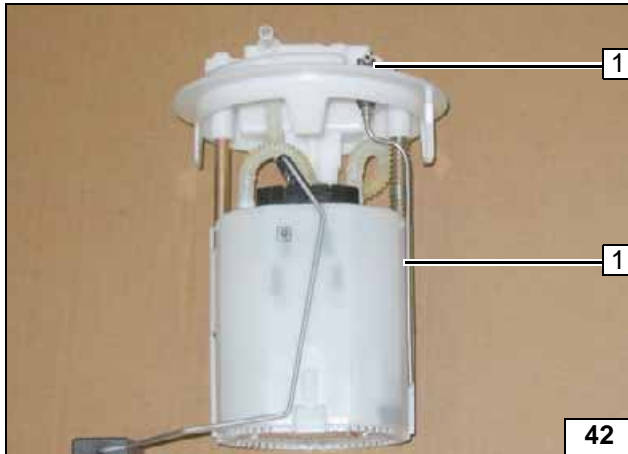
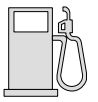

Shape fuel standpipe 1 according to template, cut to length and install.



Installing fuel standpipe

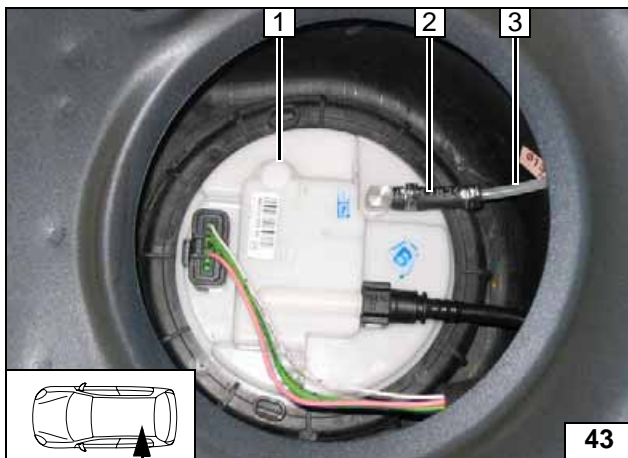

Install fuel-tank sending unit 1 in accordance with manufacturer's specifications.



Connecting fuel line

- 2 Hose section, 10 mm dia. Caillau clamp [2x]
- 3 Fuel line

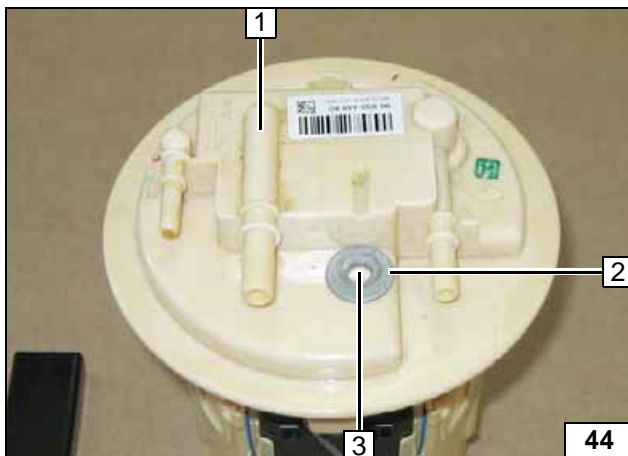

Diesel

Remove fuel-tank sending unit 1 in accordance with manufacturer's specifications.



Removing fuel

- 2 Large diameter washer
- 3 Copy hole pattern, 6 mm dia. hole

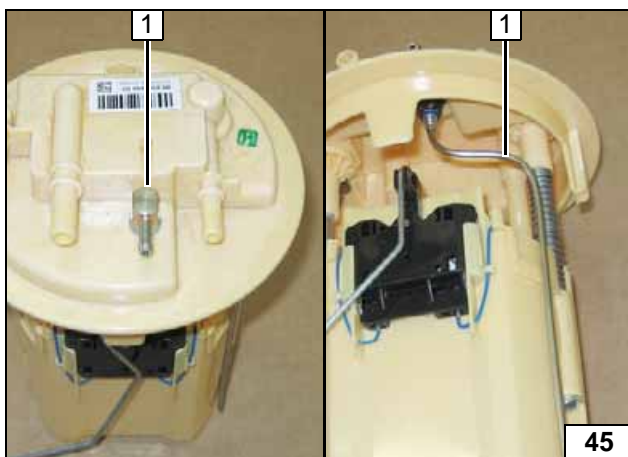

Shape fuel standpipe 1 according to template, cut to length and install.



Installing fuel standpipe

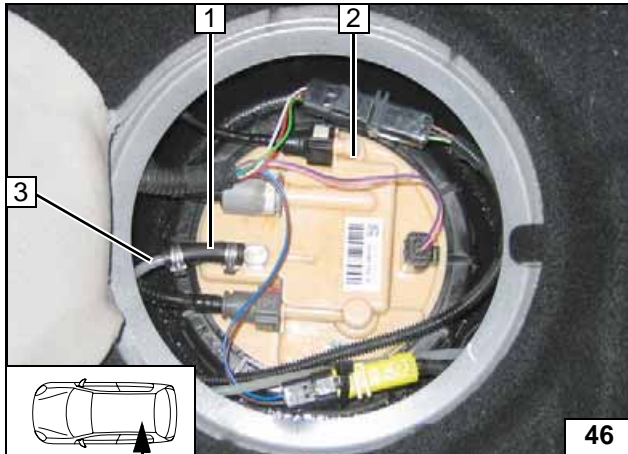

Install fuel-tank sending unit **2** in accordance with manufacturer's specifications.

- 1** Hose section, 10 mm dia. Caillau clamp [2x]
- 3** Fuel line



**Connect-
ing fuel
line**

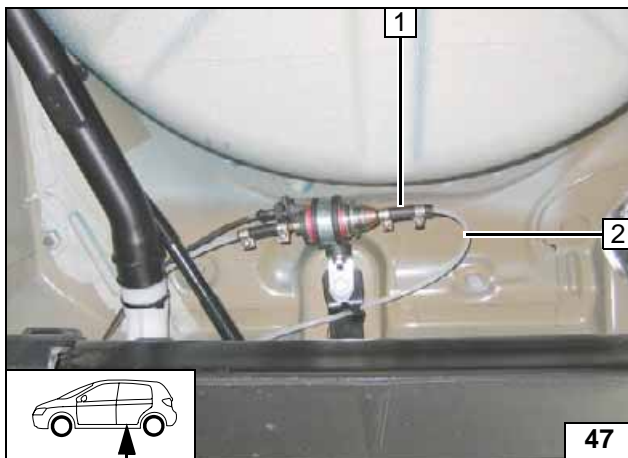

All vehicles

Check the position of the components; adjust if necessary. Check that they have free clearance.

- 1** Hose section, 10 mm dia. clamp [2x]
- 2** Fuel line



**Connect-
ing meter-
ing pump**

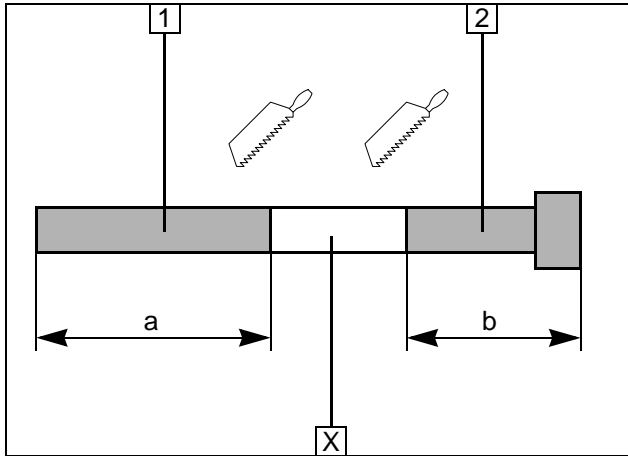
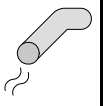

Exhaust gas

Discard section X.

- 1 Exhaust pipe
a = 230
- 2 Exhaust end section
b = 100



Preparing exhaust pipe

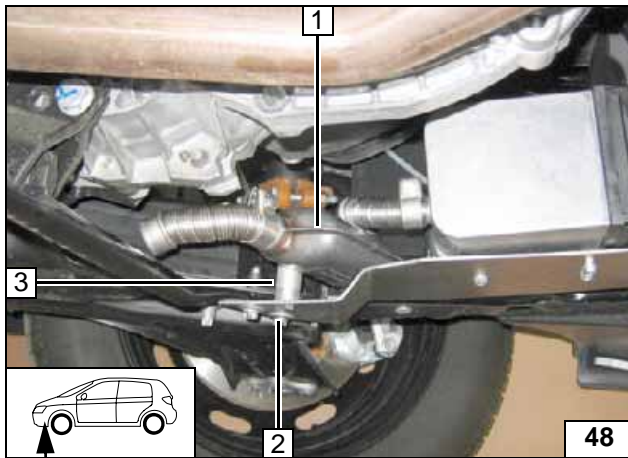

- 1 Muffler
- 2 M6x55 bolt, flanged nut
- 3 Shim 40

Installing muffler

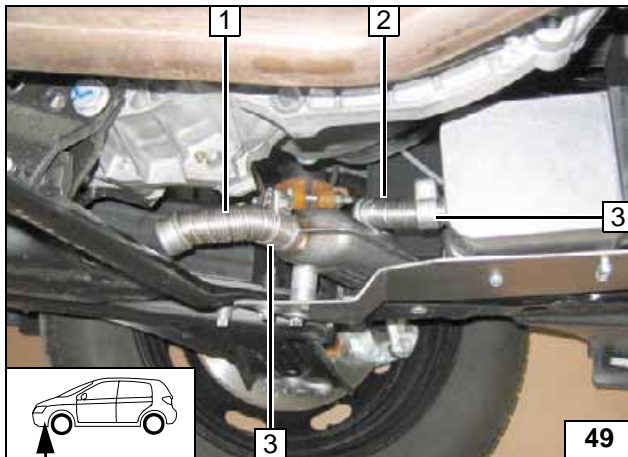

- 1 Exhaust end section
- 2 Exhaust pipe
- 3 Hose clamp [2x]

Installing exhaust pipe and end section

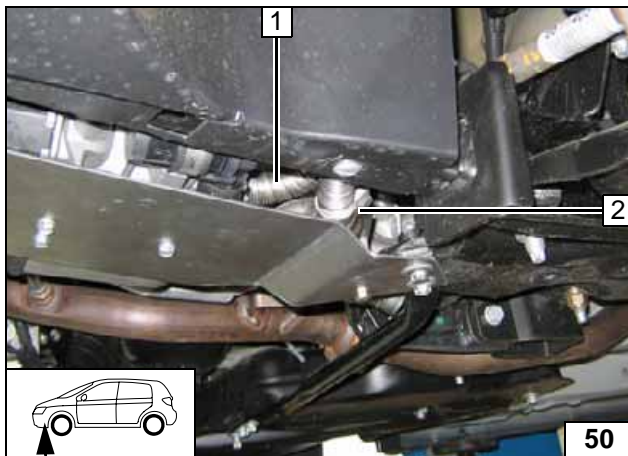

- 1 Exhaust pipe
- 2 Hose clamp

Installing exhaust pipe

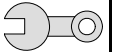

Final Work

WARNING!

Mount removed parts in reverse order.

Check all hoses, clamps and all electrical connections for firm seating.

Secure all loose cables using cable ties.

Only use manufacturer-approved coolant.

Spray heater components with anti-corrosion wax (Tectyl 100K, Order No. 111329).

- Connect the battery.
- Fill and bleed the coolant circuit according to the vehicle manufacturer's specifications.
- Set the digital timer.
- Make settings on A/C control panel according to the "Operating Instructions for End Customer".
- Check the proper operation of the parking heater, see the operating instructions/installation instructions.
- Attach instruction label "Switch off parking heater before refueling" in the area of the filling neck



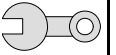

Template for Gasoline Fuel Standpipe

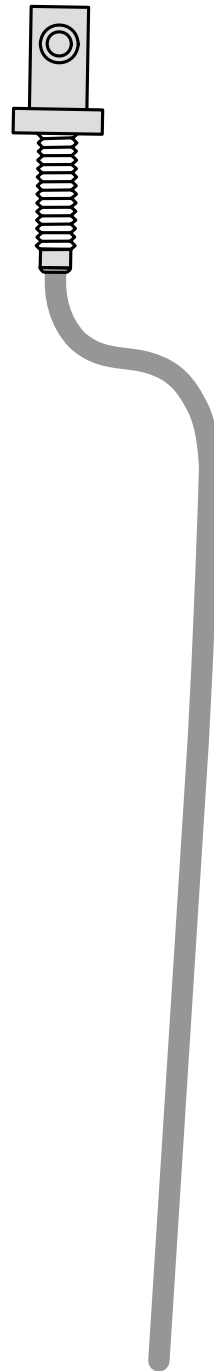

100 mm



Scale 1:1

Compare the size of the printed version with dimension lines.
Permitted tolerance a maximum of 2%.

Set the printer settings to "no margin" or "minimise margins" and
100% of the normal size.

100 mm

0

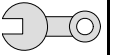

Template for Diesel fuel standpipe

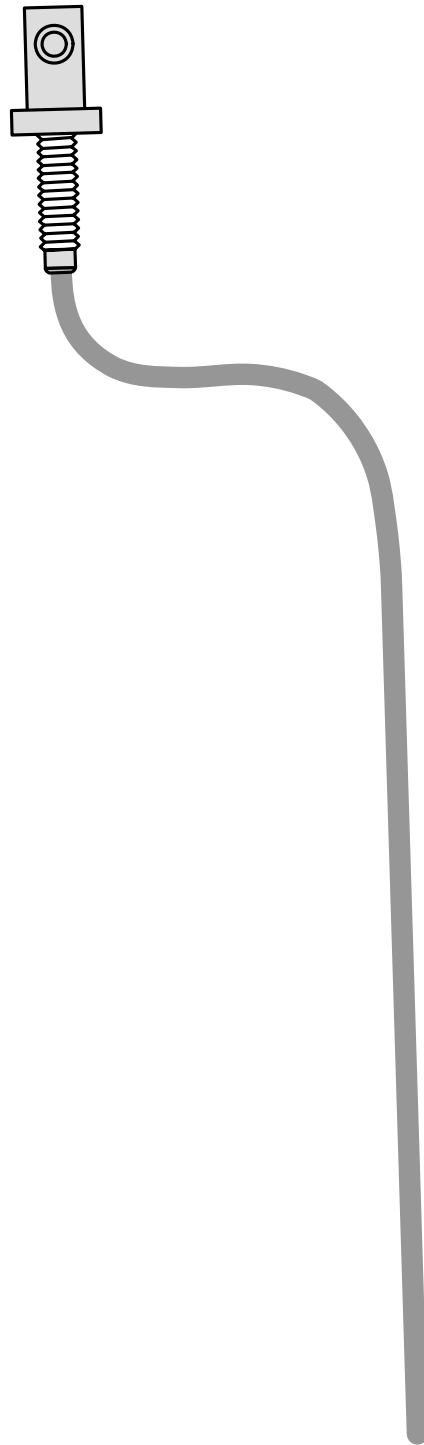

100 mm



Scale 1:1

Compare the size of the printed version with dimension lines.
Permitted tolerance a maximum of 2%.

Set the printer settings to "no margin" or "minimise margins" and
100% of the normal size.

100 mm

0

Operating Instructions for End Customer



Please remove page and add to the vehicle operating instructions.

Note:

We recommend matching the heating time to the driving time.

Heating time = driving time

Example:

For a driving time of approx. 20 min. (in one direction), we recommend not exceeding a switch-on time of 20 min.

On vehicles with passenger compartment monitoring, this must be deactivated during heating!



If the summer/winter switch option has been installed, this must be switched in accordance with the time of year. The heater will then only switch on the vehicle fan to ventilate the vehicle interior in the position Winter heat and in the position Summer .

Before parking the vehicle, make the following settings:

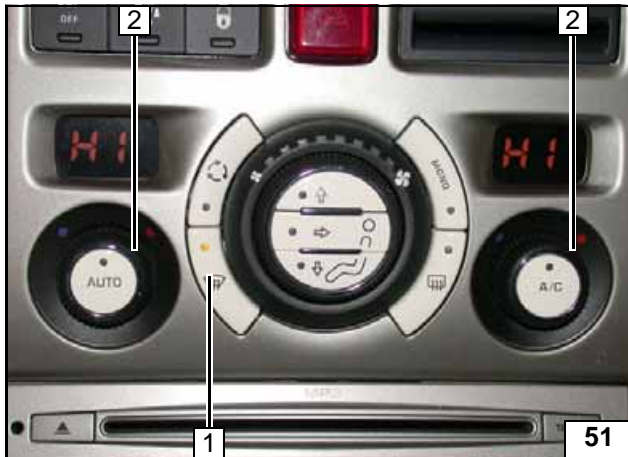

- 1 Air outlet to windshield
- 2 Set temperature on both sides to "HI".

**Automatic
air-conditioning**