

Water Heater

Thermo Top Evo Parking Heater



With FuelFix

Installation Documentation Ford Focus / C-Max / Grand C-Max

Validity

Manufacturer	Model	Type	EG BE No. / ABE
Ford	Focus	DYB	e13 * 2007 / 46 * 1138 * ...

Motorisation	Fuel	Transmission type	Output in kW	Displacement in cm ³	Engine code
2.0 TDCi	Diesel	6-speed SG	110	1997	T7CE
2.0 TDCi	Diesel	AG	110	1997	T7CE

Manufacturer	Model	Type	EG BE No. / ABE
Ford	C-Max	DXA	e13 * 2007 / 46 * 1103 * ...
Ford	Grand C-Max	DXA	e13 * 2007 / 46 * 1103 * ...

Motorisation	Fuel	Transmission type	Output in kW	Displacement in cm ³	Engine code
2.0 TDCi	Diesel	AG	110	1997	T7DB

SG = manual transmission
AG = automatic transmission

From model year 2015
Left-hand drive vehicle

Verified equipment variants: Manual air-conditioning (Focus and C-Max)
Automatic air-conditioning (Focus only)
Front fog lights
Headlight washer system
Automatic Start-Stop system
Euro 6

Not verified: Passenger compartment monitoring

Total installation time: approx. 9.5 hours

Table of Contents

Validity	1	MultiControl CAR Option	14
Necessary Components	2	Remote Option (Telestart)	14
Installation Overview	2	ThermoCall Option	16
Information on Total Installation Time	2	Preparing Installation Location	17
Information on Operating and Installation Instructions	3	Preparing Heater	17
Information on Validity	4	Installing Heater	20
Technical Information	4	Fuel	22
Explanatory Notes on Document	4	FuelFix Installation, Fuel Tank Sending Unit Version 1	23
Preliminary Work	5	FuelFix Installation, Fuel Tank Sending Unit Version 2	26
Heater Installation Location	5	Coolant Circuit	33
Preparing Electrical System	6	Combustion Air	36
Wiring Harness Routing for Focus	8	Exhaust Gas	37
Wiring Harness Routing for C-Max / Grand C-Max	9	Final Work	39
Electrical System for all Vehicles	10	FuelFix Template for Fuel Tank Sending Unit Version 1	40
Fan Controller for Focus	11	FuelFix Template for Fuel Tank Sending Unit Version 2	41
Fan Controller for C-Max / Grand C-Max	12	Operating Instructions for Focus with Man. A/C	42
Automatic Air-Conditioning Control (Focus only)	14	Operating Instructions for C-Max / Grand C-Max with Man. A/C	43

Necessary Components

- Basic delivery scope of Thermo Top Evo based on price list
- Installation kit with FuelFix for Ford Focus / C-Max / Grand C-Max 2015 Diesel: **1323872A**
- To be ordered additionally in case of automatic air-conditioning (Focus only) either:
Additional kit 'Webasto Standard' A/C control for Ford Focus: **1324049_**
or
Additional kit 'Webasto Comfort' A/C control for Ford Focus: **1324107_**
- Heater control in accordance with price list and upon consultation with end customer
- In case of Telestart, indicator lamp in accordance with price list and in consultation with end customer
- In case of MultiControl CAR installation: Timer wiring harness extension: **1319724_**
- In case of MultiControl CAR installation: MultiControl installation frame: **9030077_**

Installation instructions:

- Arrange for the vehicle to be delivered with the tank only about ¼ full.
- The installation location of the push button in case of Telestart or ThermoCall should be confirmed with the end customer.
- Depending on the space required and the vehicle manufacturer's instructions, we recommend the use of a vehicle battery with a higher electrical capacity.

Installation Overview

Legend:

1. Heater
2. Engine compartment fuse holder
3. Passenger compartment relay and fuse holder
4. Circulating pump
5. MultiControl CAR
6. Metering pump
7. FuelFix

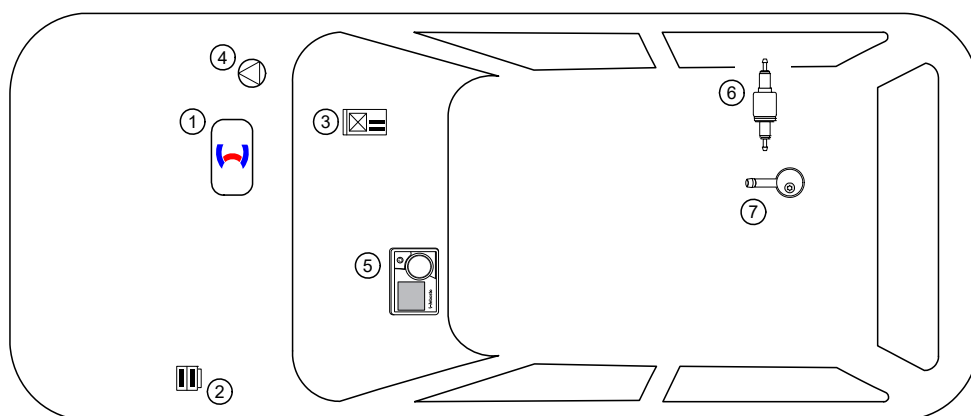

Information on Total Installation Time

The total installation time includes the time needed for mounting and demounting the vehicle-specific components, the heater specific installation time and all other times required for the system integration and initial start-up of the heater. The total installation time may vary for vehicle equipment other than provided.

Information on Operating and Installation Instructions

1 Important information (not complete)

1.1 Installation and repair



The improper installation or repair of Webasto heating and cooling systems can cause fire or the leakage of deadly carbon monoxide, leading to serious injury or death.



To install and repair Webasto heating and cooling systems you need to have completed a special company training course and have the appropriate technical documentation, special tools and special equipment.



Installation and repair may ONLY be carried out by persons trained and certified in a Webasto training course. NEVER try to install or repair Webasto heating or cooling systems if you have not completed a Webasto training course, you do not have the necessary technical skills and you do not have the technical documentation, tools and equipment available to ensure that you can complete the installation and repair work properly.

Only use genuine Webasto parts. See the Webasto air and water heaters accessories catalogue for this purpose.

1.2 Operation

To ensure safe operation, we recommend having the heater checked every two years by an authorised Webasto dealer, especially when used over a long period and/or under extreme environmental conditions.

Do not operate the heater in closed rooms due to the danger of poisoning and suffocation.

Always switch off the heater before refuelling.

The heater may only be used with the prescribed fuel diesel (DIN EN 590) or petrol (DIN EN 228).

The heater may not be cleaned with a high-pressure cleaner.

1.3 Please note

ALWAYS follow all Webasto installation and operating instructions and observe all warnings.

To become familiar with and understand all functions and properties of the heater, the operating instructions must be read carefully and observed at all times.

For proper, safe installation and repair work, the installation instructions with all warnings and safety information must be carefully read and observed at all times. Please always contact a workshop authorised by Webasto for all installation and repair work.

Important

Webasto shall assume no liability for defects, damage and injuries resulting from a failure to observe the installation, repair and operating instructions of the information contained in them.

This liability exclusion particularly applies to improper installations and repairs, installations and repairs by untrained persons or in the case of a failure to use genuine spare parts.

The liability due to culpable disregard to life, limb or health and due to damage or injuries caused by a wilful or reckless breach of duty remain unaffected, as does the obligatory product liability.

Installation should be carried out according to the general, standard rules of technology. Unless specified otherwise, fasten hoses, lines and wiring harnesses to original vehicle lines and wiring harnesses using cable ties. Insulate loose wire ends and tie back. Connectors on electronic components have to audibly click into place during installation.

Sharp edges should be fitted with rub protection. Spray unfinished body areas, e.g. drilled holes, with anti-corrosion wax (Tectyl 100K).

Observe the instructions and guidelines of the respective vehicle manufacturer for demounting and mounting vehicle specific components!

The initial startup is to be executed with the Webasto Thermo Test Diagnosis.

When installing a programmable control module (e.g. a PWM Gateway), the corresponding settings must be checked or adjusted.

2 Statutory regulations governing installation

Guidelines	Thermo Top Evo
Heating Directive ECE R122	E1 00 0258
EMC Directive ECE R10	E1 04 5627

Note

The regulations of these guidelines are binding in the scope of the Directive 70/156/EEC and/or 2007/46/EC (for new vehicle models from 29/04/2009) and should also be observed in countries in which there are no special regulations.

Important

Failure to follow the installation instructions will result in the invalidation of the type approval for the heater and therefore invalidation of the general **homologation of the vehicle**.

Note

The heater is licensed in accordance with paragraph 19, section 3, No. 2b of the StVZO (German Road Traffic Licensing Authority).

2.1 Excerpt from ECE regulation 122 (heating system) paragraph 5 for the installation of the heater

Beginning of excerpt.

ANNEX VII

REQUIREMENTS FOR COMBUSTION HEATERS AND THEIR INSTALLATION

1. GENERAL REQUIREMENTS

1.7.1. A clearly visible tell-tale in the operator's field of view shall inform when the combustion heater is switched on or off.

2. VEHICLE INSTALLATION REQUIREMENTS

2.1. Scope

2.1.1. Subject to paragraph 2.1.2, combustion heaters shall be installed according to the requirements of this Annex.

2.1.2. Vehicles of category O having liquid fuel heaters are deemed to comply with the requirements of this Annex.

2.2. Positioning of heater

2.2.1. Body sections and any other components in the vicinity of the heater must be protected from excessive heat and the possibility of fuel or oil contamination.

2.2.2. The combustion heater shall not constitute a risk of fire, even in the case of overheating. This requirement shall be deemed to be fulfilled if the installation ensures an adequate distance to all parts and suitable ventilation, by the use of fire resistant materials or by the use of heat shields.

2.2.3. In the case of M2 and M3 vehicles, the heater must not be positioned in the passenger compartment. However, an installation in an effectively sealed envelope which also complies with the conditions in paragraph 2.2.2 may be used.

2.2.4. The label referred to in paragraph 1.4 or a duplicate, must be positioned so that it can be easily read when the heater is installed in the vehicle.

2.2.5. Every reasonable precaution should be taken in positioning the heater to minimise the risk of injury and damage to personal property.

2.3. Fuel supply

2.3.1. The fuel filler must not be situated in the passenger compartment and must be provided with an effective cap to prevent fuel spillage.

2.3.2. In the case of liquid fuel heaters, where a supply separate to that of the vehicle is provided, the type of fuel and its filler point must be clearly labelled.

2.3.3. A notice, indicating that the heater must be shut down before refuelling, must be affixed to the fuelling point. In addition a suitable instruction must be included in the manufacturer's operating manual.

2.4. Exhaust system

2.4.1. The exhaust outlet must be located so as to prevent emissions from entering the vehicle through ventilators, heated air inlets or opening windows.

2.5. Combustion air inlet

2.5.1. The air for the combustion chamber of the heater must not be drawn from the passenger compartment of the vehicle.

2.5.2. The air inlet must be so positioned or guarded that blocking by rubbish or luggage is unlikely.

2.6. Heating air inlet

2.6.1. The heating air supply may be fresh or recirculated air and must be drawn from a clean area not likely to be contaminated by exhaust fumes emitted either by the propulsion engine, the combustion heater or any other vehicle source.

2.6.2. The inlet duct must be protected by mesh or other suitable means.

2.7. Heating air outlet

2.7.1. Any ducting used to route the hot air through the vehicle must be so positioned or protected that no injury or damage could be caused if it were to be touched.

2.7.2. The air outlet must be so positioned or guarded that blocking by rubbish or luggage is unlikely.

End of excerpt.

In multilingual versions the German language is binding.

Information on Validity

This installation documentation applies to Ford Focus / C-Max / Grand C-Max Diesel vehicles - for validity, see page 1 - from model year 2015 and later, assuming technical modifications to the vehicle do not affect installation, any liability claims excluded. Depending on the vehicle version and equipment, modifications may be necessary during installation with respect to this 'installation documentation'.

Vehicle and engine types, equipment variants and other specifications not listed in this installation documentation have not been tested. However, installation according to this installation documentation may be possible.

Technical Information

Special Tools

- Hose clamp pliers for auto-tightening hose clamps
- Hose clamp pliers for Clic hose clamps of type W
- Automatic wire stripper, 0.2 - 6mm²
- Crimping pliers for cable lug / tab connector, 0.5 - 6mm²
- Torque wrench for 2.0 - 10 Nm
- Hose clamping pliers
- Metric thread-setter kit
- Deep-hole marker
- Webasto Thermo Test Diagnosis with current software

Dimensions

- All dimensions are in mm.

Tightening torque values

- Tightening torque values of 5x13 heater bolts and 5x11 heater stud bolts = 8Nm.
- Tightening torque value of 5x15 water connection piece retaining plate bolt = 7Nm.
- Tighten other bolt connections in accordance with manufacturer's instructions or in accordance with state-of-the-art technology.

Explanatory Notes on Document

You will find an identification mark on the outside top right corner of the page in question to provide you with a quick overview of the individual working steps.

Special features are highlighted using the following symbols:

Mechanical System



Electrical System



Coolant Circuit



Combustion Air



Fuel



Exhaust Gas



Software



Specific risk of damage to components.



Specific risk due to electrical voltage.



Specific risk of injury or fatal accidents.



Specific risk of fire or explosion.



Reference to the manufacturer's vehicle-specific documents or to the general installation instructions of Webasto components.



Reference to a special technical feature.



The arrow in the vehicle icon indicates the position on the vehicle and the viewing angle.



Tightening torque according to the manufacturer's vehicle-specific documents.



Preliminary Work

Vehicle



- Open the fuel tank cap.
- Ventilate the fuel tank.
- Close the fuel tank cap again.
- Depressurise the cooling system.
- Disconnect and remove the battery.
- Remove the engine cover.
- Remove the windscreen wiper.
- Remove the upper cover of the coolant reservoir.
- Remove the cover of the coolant reservoir for the engine compartment.
- Drain the coolant according to the manufacturer's instructions.
- Remove the air filter housing.
- Remove the engine underride protection.
- Remove the underbody trim on the right next to the tank.



- Remove the exhaust system from the bracket in the rear part.
- Detach the heat protection trim of the exhaust system in the area of the tank.
- Remove the fuel tank according to the manufacturer's instructions.
- Remove the footwell trim on the front passenger's side.
- Remove the A-pillar trim of the footwell on the front passenger's side (only in case of Telestart).
- Remove glove box (C-Max / Grand C-Max only)

Heater

- Remove years that do not apply from the type and duplicate label.
- Attach the duplicate label (type label) visibly in the appropriate place in the engine compartment.

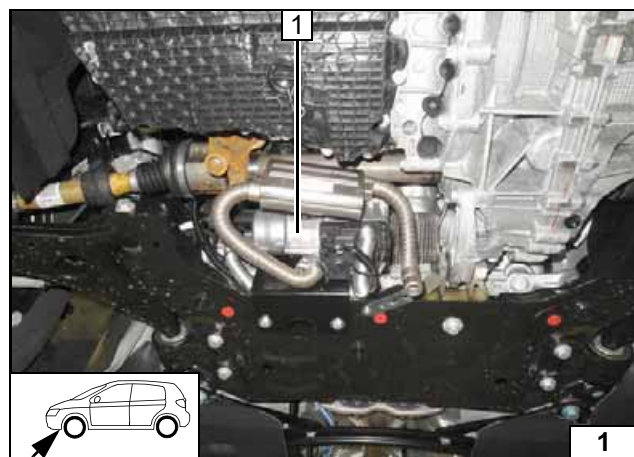

Heater Installation Location

- 1 Heater

Installation location

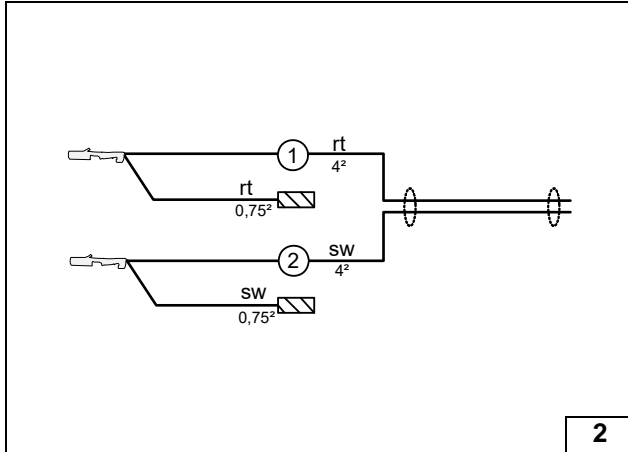
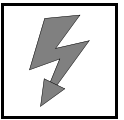

Preparing Electrical System

Wire sections retain their numbering in the entire document.

Produce all following electrical connections as shown in the wiring diagram.

Manual air-conditioning

- ① Red (rt) wire of fan wiring harness
- ② Black (sw) wire of fan wiring harness



Assigning wires

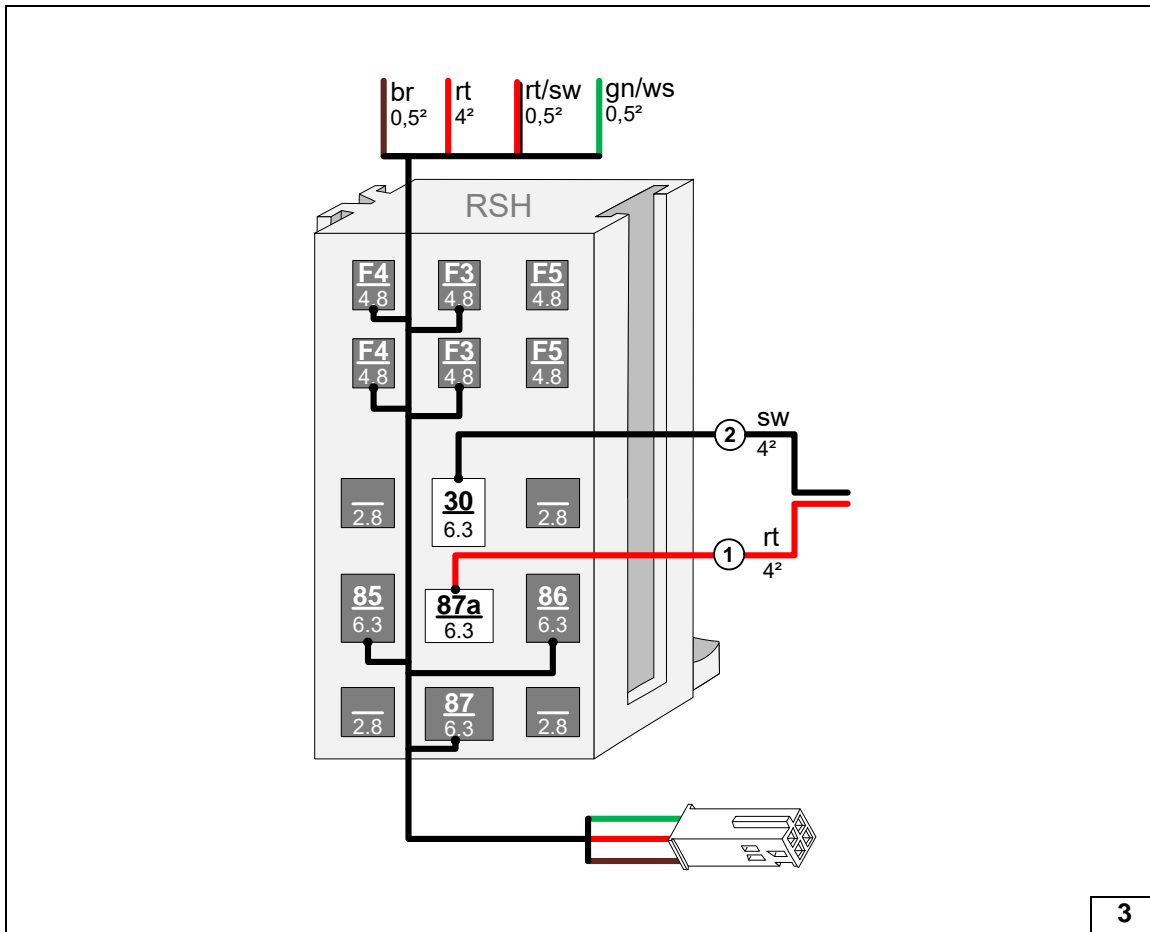

Connecting wires to passenger compartment relay and fuse holder

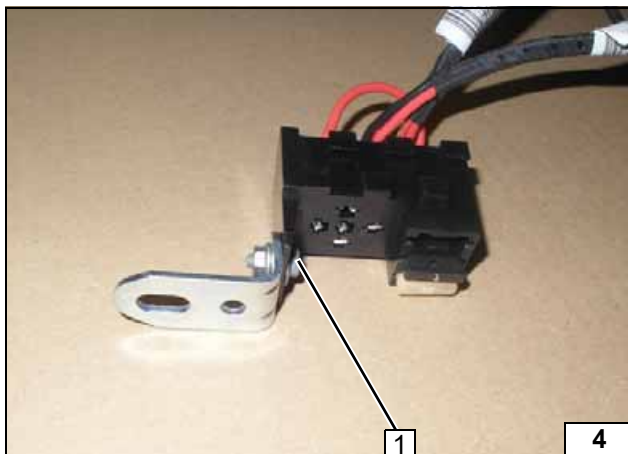

Focus

- 1 M5x16 bolt, large diameter washer, passenger compartment relay and fuse holder tab, angle bracket, large diameter washer, nut



Premounting angle bracket

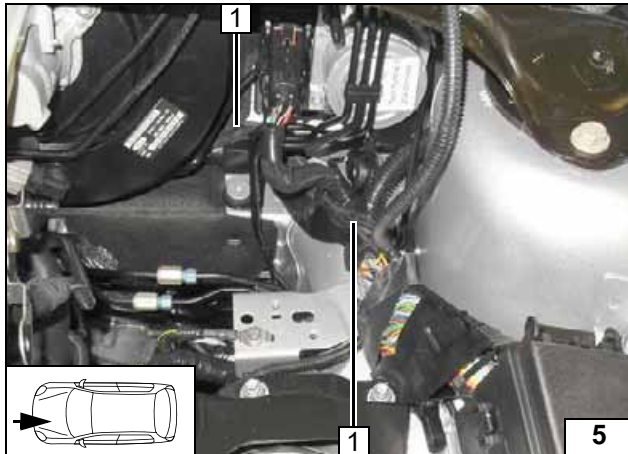
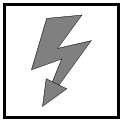

All vehicles

Route wiring harnesses of heater, heater control and passenger compartment relay and fuse holder 1 along original vehicle wires to right side of vehicle.



Routing wiring harness

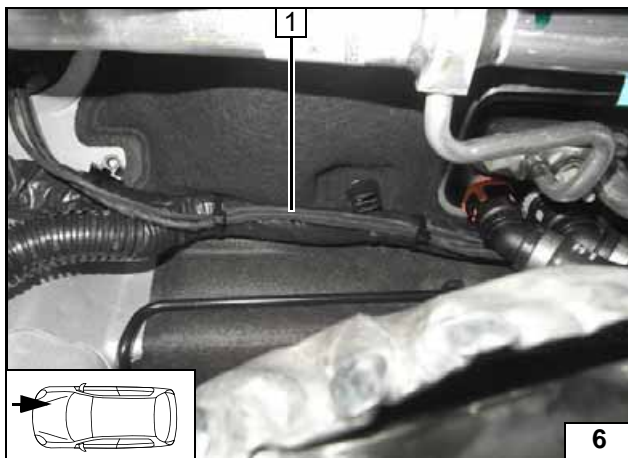

Route wiring harnesses of heater control and passenger compartment relay and fuse holder 1 along original vehicle lines to wiring harness pass through.



Routing wiring harness

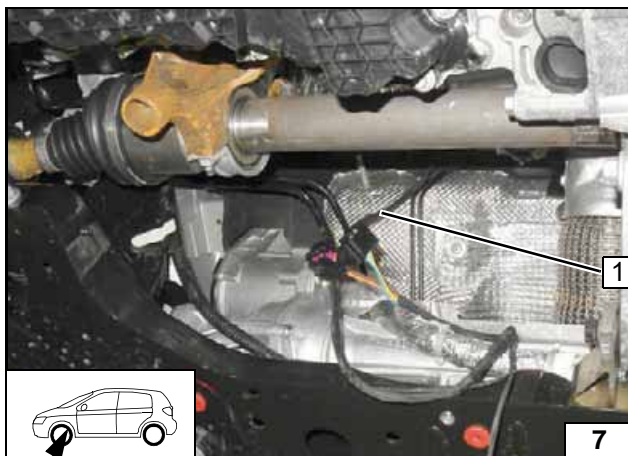

Route heater wiring harness 1 on a level with the heat exchanger connection and brake lines to the installation location of the heater.



Routing wiring harness

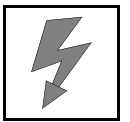

Wiring Harness Routing for Focus



Positive wire

- 1 Positive wire on positive battery terminal

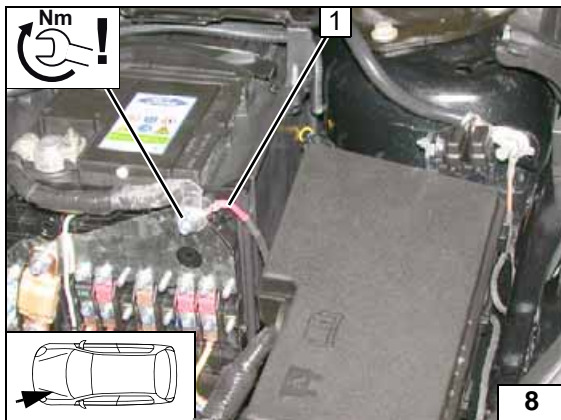

Wiring harness pass through

- 1 Protective rubber plug

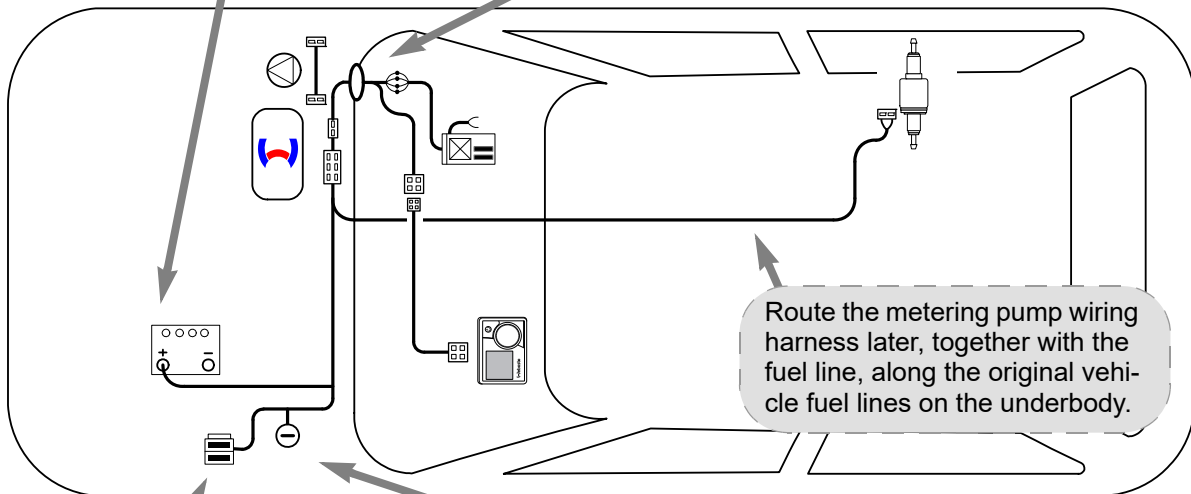
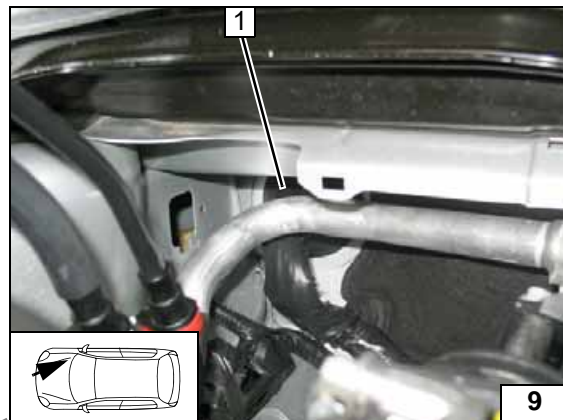

Wiring harness routing diagram for Focus (manual A/C)

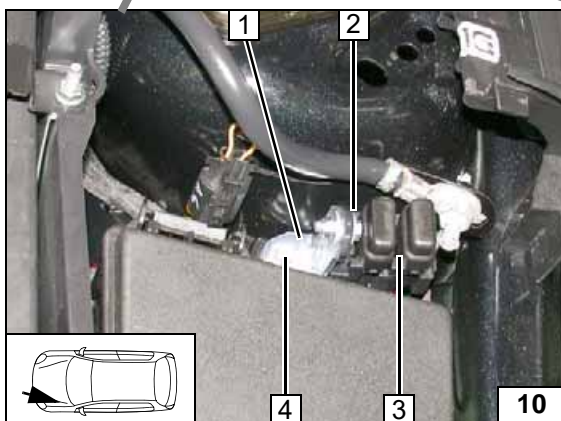

Engine compartment fuse holder

- 1 Angle bracket
- 2 M5x16 bolt, large diameter washer [2x], retaining plate of fuse holder, nut
- 3 Fuses F1-2
- 4 M6x20 bolt, flanged nut, existing hole

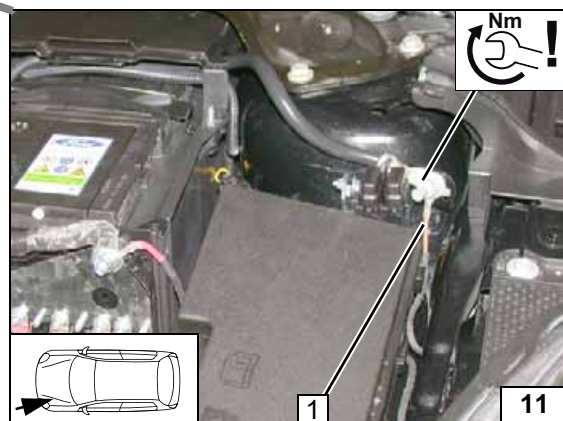

Earth wire

- 1 Earth wire, 8 mm dia. cable lug at original vehicle earth support point





Wiring Harness Routing for C-Max / Grand C-Max



Positive wire

- 1 Positive wire on positive battery terminal

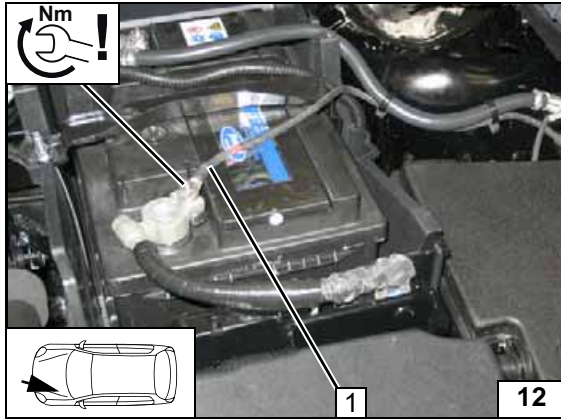

Wiring harness pass through

- 1 Protective rubber plug

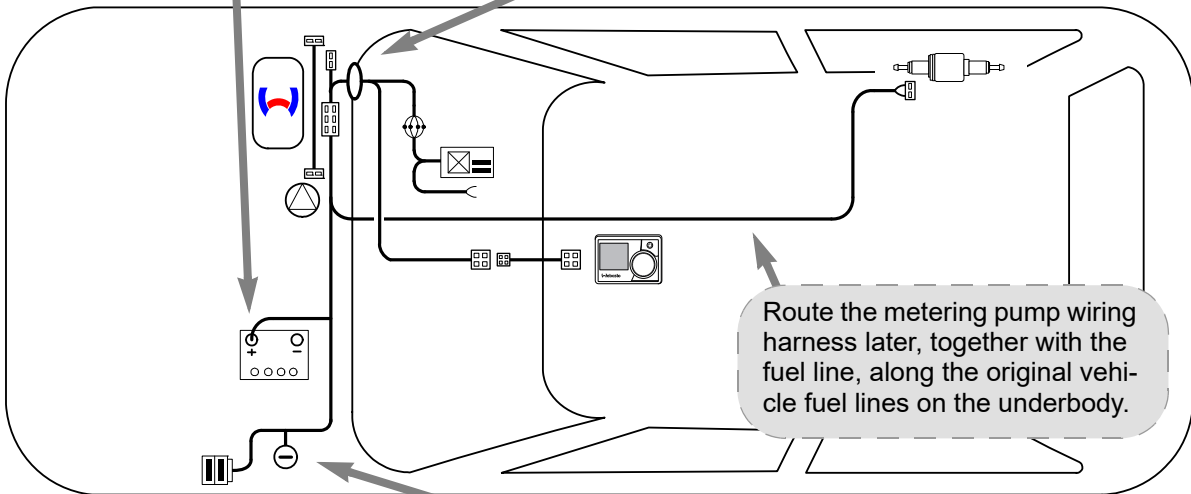
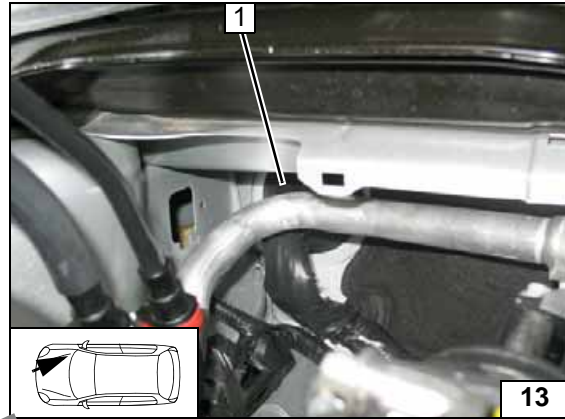

Wiring harness routing diagram for C-Max / Grand C-Max (manual A/C)

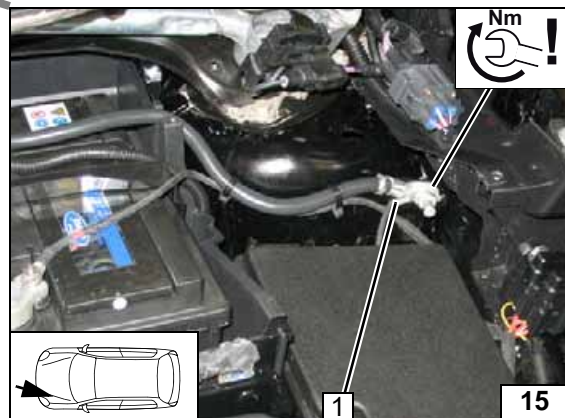
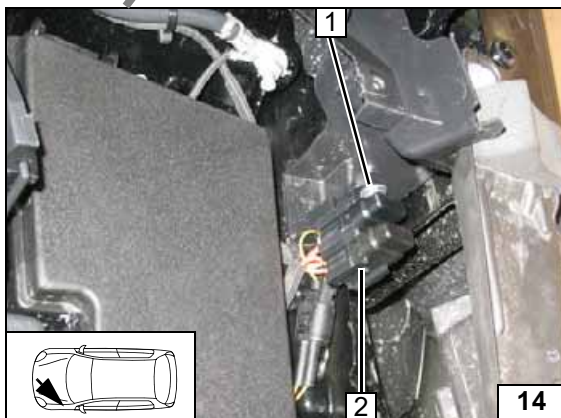

Engine compartment fuse holder

When drilling, be careful of components located behind!

- 1 5.5mm dia. hole, M5x16 bolt, large diameter washer, retaining plate of fuse holder, nut
- 2 Fuses F1-2

Earth wire

- 1 Earth wire, 8 mm dia. cable lug at original vehicle earth support point



Electrical System for all Vehicles

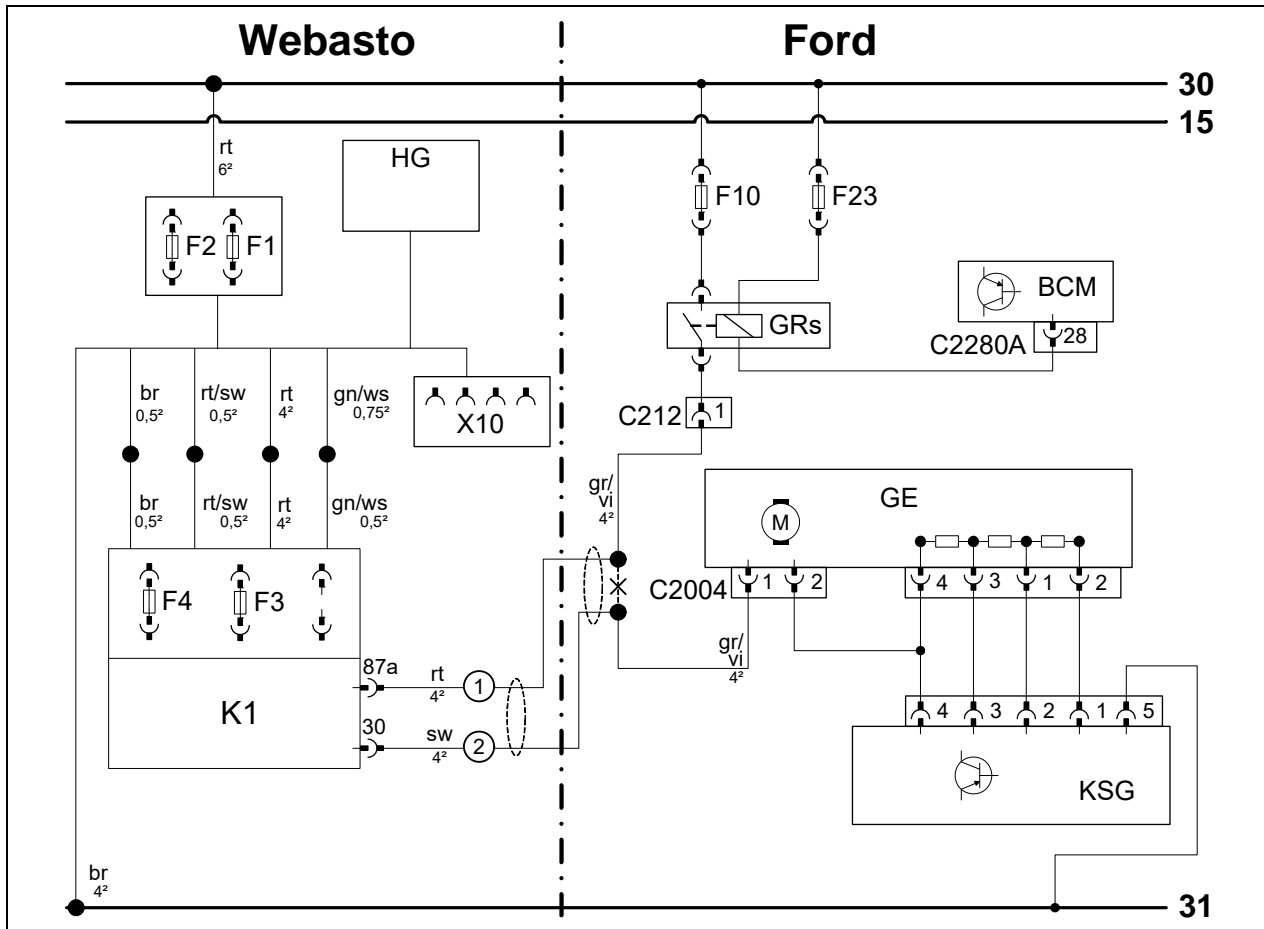

System wiring diagram (manual air-conditioning)

Webasto components		Vehicle components		Colours and symbols	
HG	TT-Evo heater	F10	40A fuse	rt	red
F1	20A fuse	F23	5A fuse	sw	black
F2	30A fuse	BCM	Body control unit	ge	yellow
X10	4-pin connector of heater control	C2280A	Connector of BCM	gn	green
F3	1A fuse	GRs	Fan relay	ws	white
F4	25A fuse	C212	Connector	br	brown
K1	Fan relay	GE	Fan motor with resistor group	gr	grey
		C2004	Connector of GE	vi	violet
		KSG	A/C control unit		
				X	Cutting point
				Wiring colours may vary.	

Legend

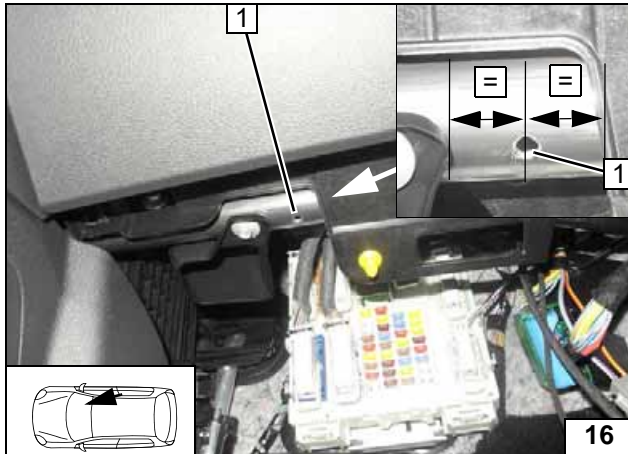
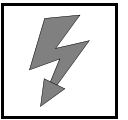

Fan Controller for Focus

- 1 5mm dia. hole

Drilling hole in instrument panel carrier

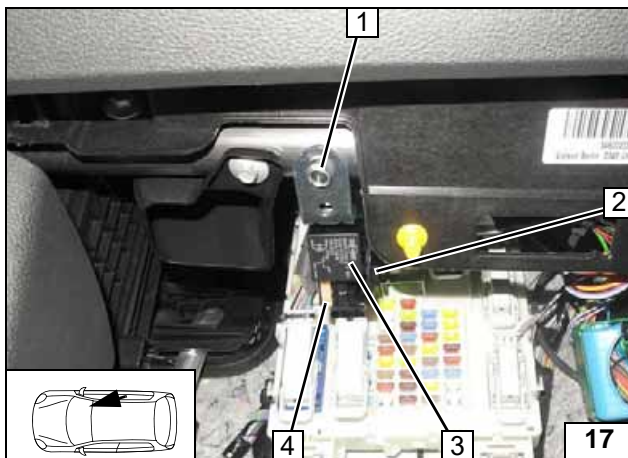

- 1 Self-tapping screw, angle bracket pre-mounted
- 2 Passenger compartment relay and fuse holder
- 3 Relay K1
- 4 25A fuse F4

Installing passenger compartment relay and fuse holder

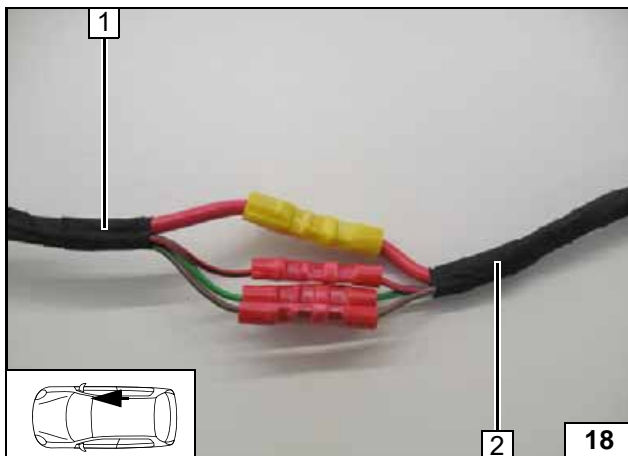

- 1 Passenger compartment relay and fuse holder wiring harness
- 2 Heater wiring harness

Connecting same colour wires of wiring harnesses

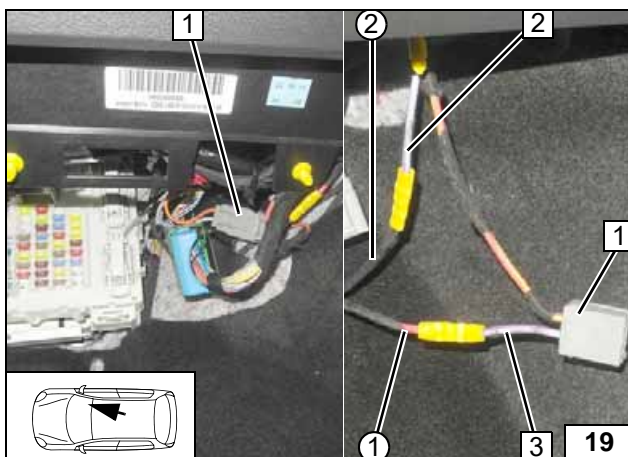

- 1 Connector C212
- 2 Grey/violet (gr/vi) wire of connector C2004 / pin 1
- 3 Grey/violet (gr/vi) wire of connector C212 / pin 1
- ① Red (rt) wire of K1/87a, fan wiring harness
- ② Black (sw) wire of K1/30, fan wiring harness

Connecting fan motor

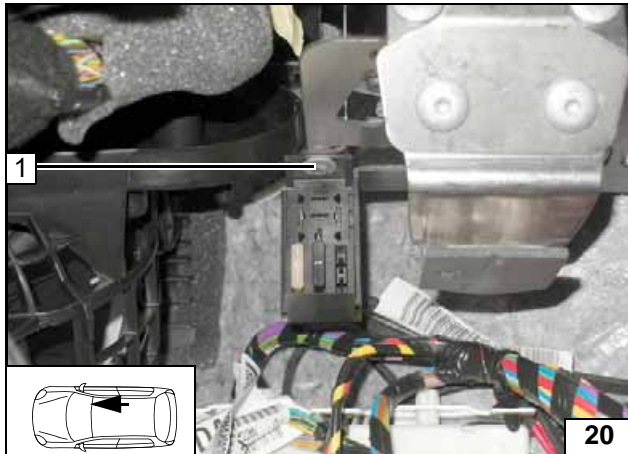
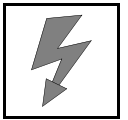

Fan Controller for C-Max / Grand C-Max

- 1 M5x16 bolt, large diameter washer, passenger compartment relay and fuse holder tab, original vehicle hole, large diameter washer, nut

Installing passenger compartment relay and fuse holder

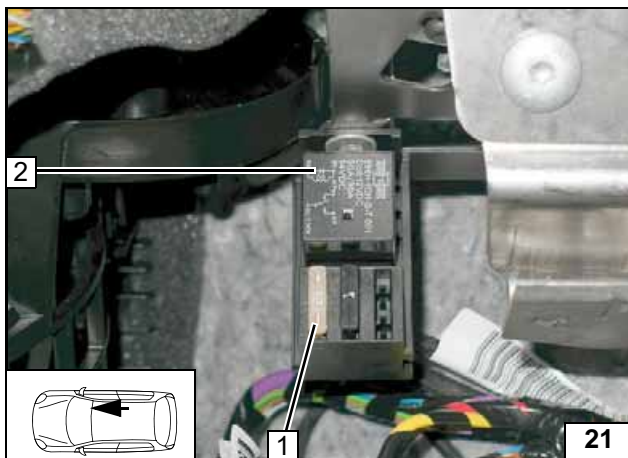

- 1 25A fuse F4
- 2 Relay K1

Inserting fuse F4 and relay K1

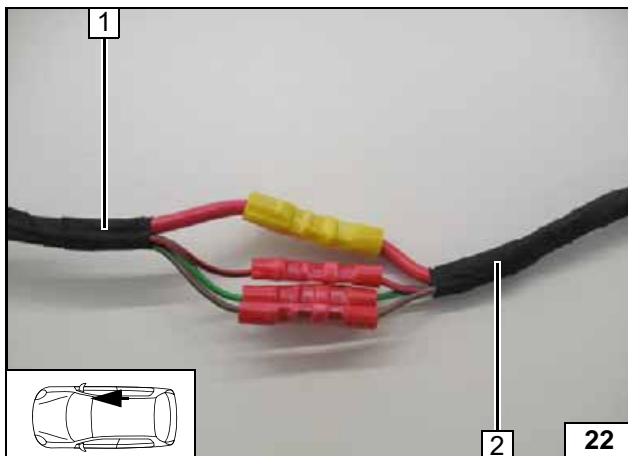

- 1 Passenger compartment relay and fuse holder wiring harness
- 2 Heater wiring harness

Connecting same colour wires of wiring harnesses

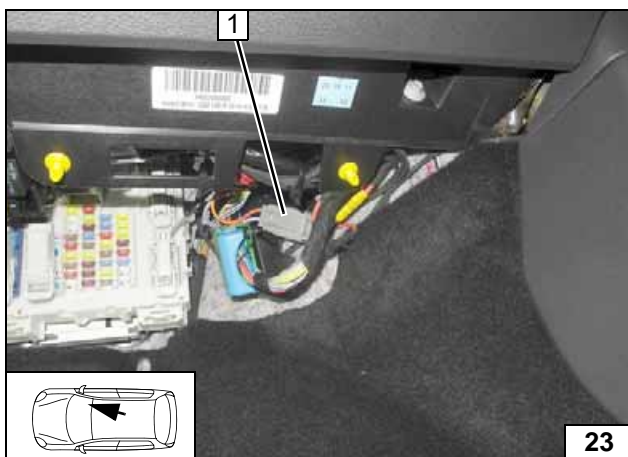

- 1 Connector C212

Locating connector C212

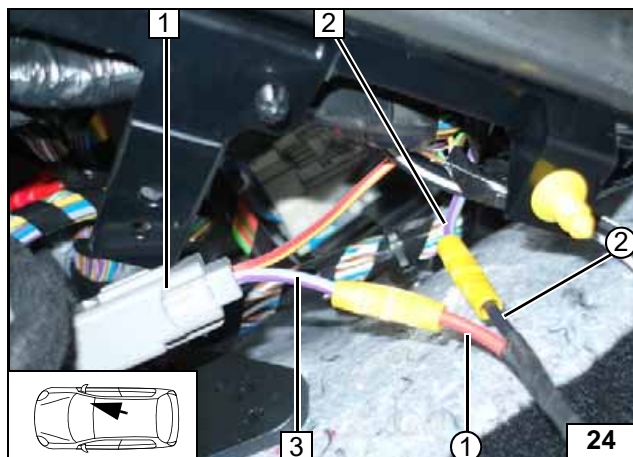

- 1 Connector C212
- 2 Grey/violet (gr/vi) wire of connector C2004 / pin 1
- 3 Grey/violet (gr/vi) wire of connector C212 / pin 1
- ① Red (rt) wire of K1/87a, fan wiring harness
- ② Black (sw) wire of K1/30, fan wiring harness

**Connect-
ing fan mo-
tor**

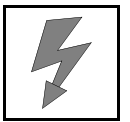

Automatic Air-Conditioning Control (Focus only)

! The connection of the A/C control for automatic air-conditioning has to be carried out in accordance with the separate installation documentation:

Installation documentation '**Webasto Standard**' A/C control AAC for Ford Focus

or

Installation documentation '**Webasto Comfort**' A/C control AAC for Ford Focus

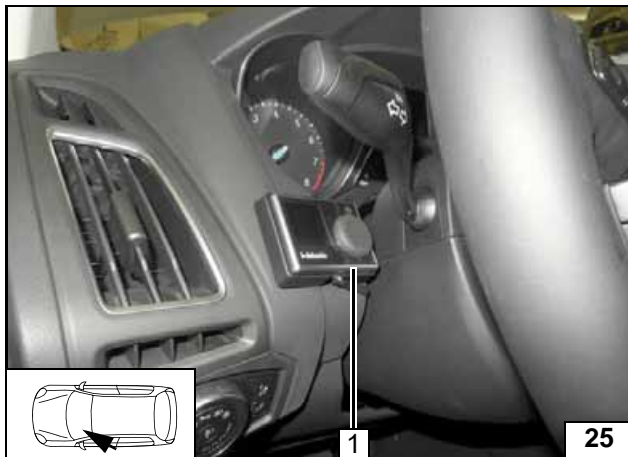

MultiControl CAR Option

Focus

- 1 MultiControl CAR with installation frame



Installing MultiControl CAR

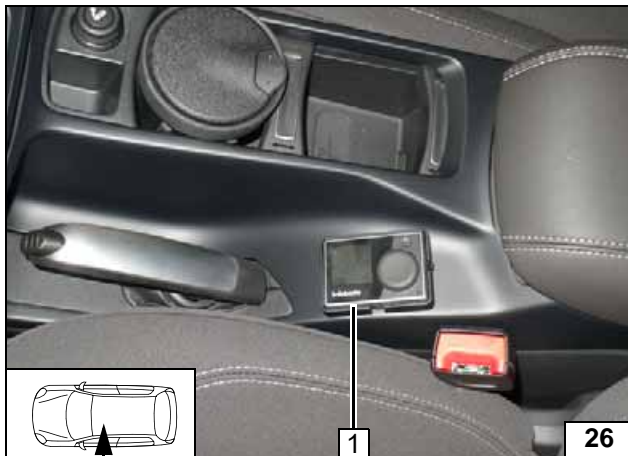

C-Max / Grand C-Max

- 1 MultiControl CAR with installation frame



Installing MultiControl CAR

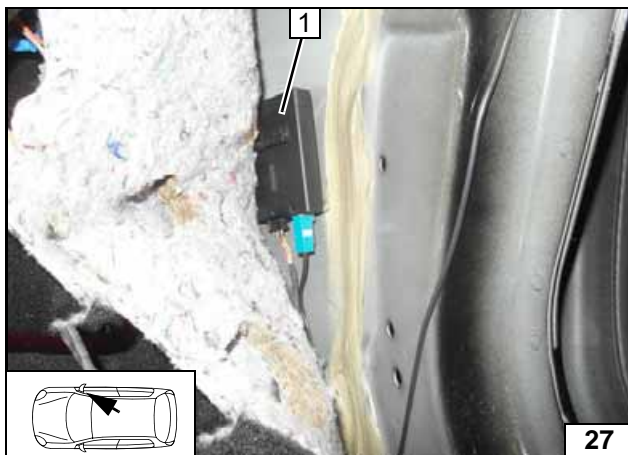

Remote Option (Telestart)

Focus

Fasten receiver 1 with double-sided adhesive tape.



Installing receiver

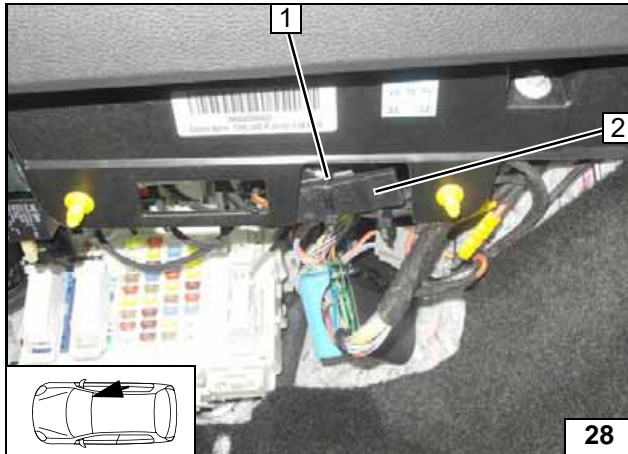
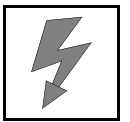

Temperature sensor T100 HTM

Fasten temperature sensor 2 with cable tie 1 to original vehicle wiring harness.



Installing temperature sensor

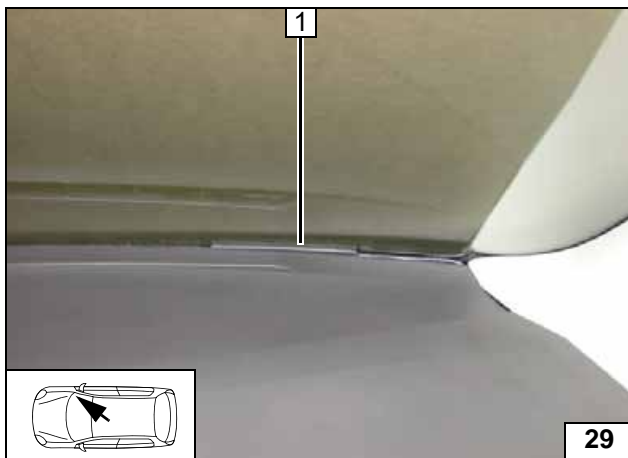

1 Aerial



Installing aerial

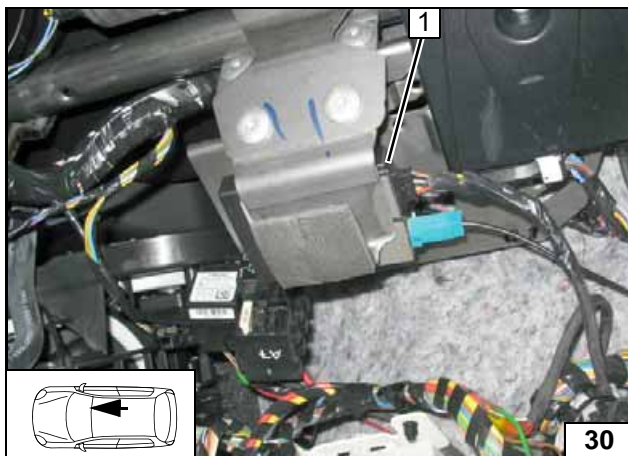

C-Max / Grand C-Max

Fasten receiver 1 with double-sided adhesive tape.



Installing receiver

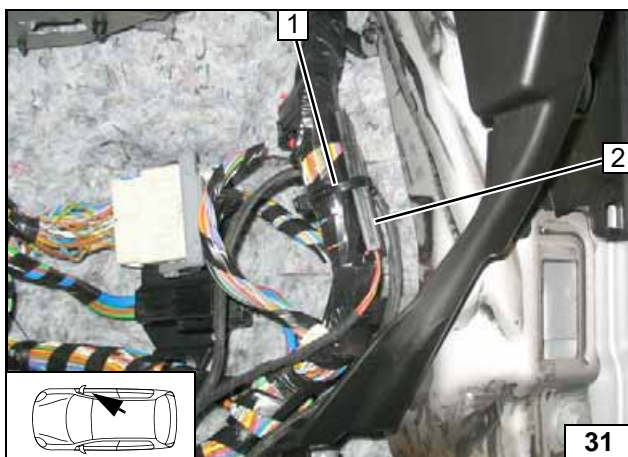

Temperature sensor T100 HTM

Fasten temperature sensor 2 with cable tie 1 to original vehicle wiring harness.



Installing temperature sensor

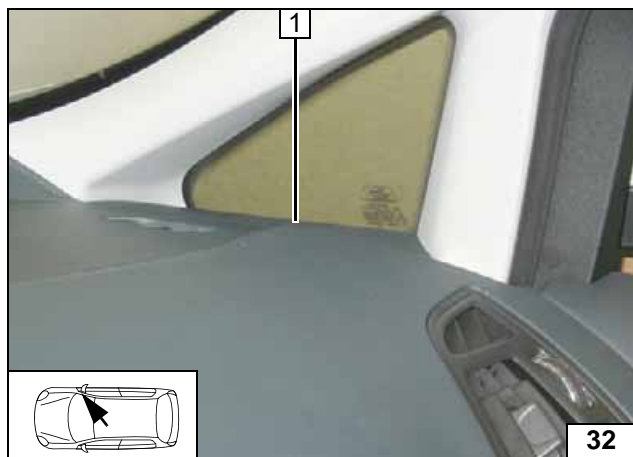

1 Aerial

Installing aerial

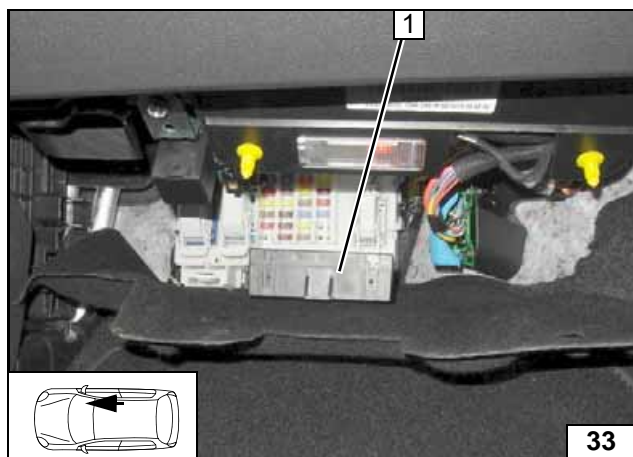

ThermoCall Option

Focus

Fasten receiver 1 with double-sided adhesive tape onto the footwell trim.



Installing receiver

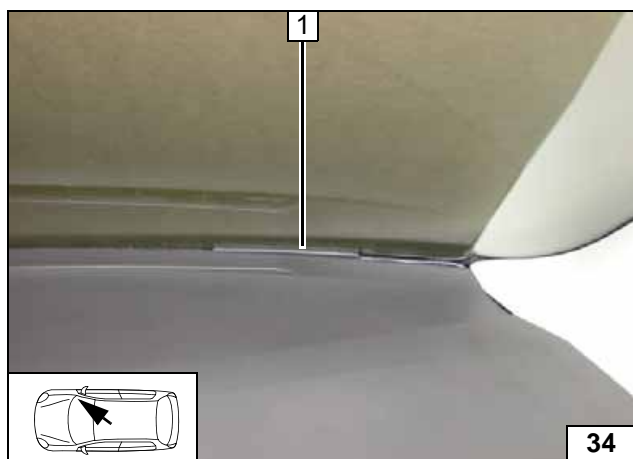

1 Aerial (optional)



Installing aerial

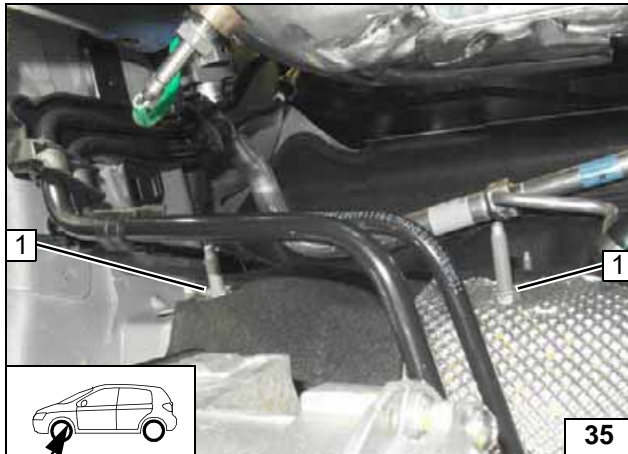
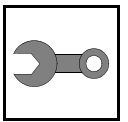

Preparing Installation Location



All vehicles

Screw M8 flanged nut 1 [2x] as far as it will go on the original vehicle stud bolt (nut is shown in the engine compartment).

Premounting flanged nut

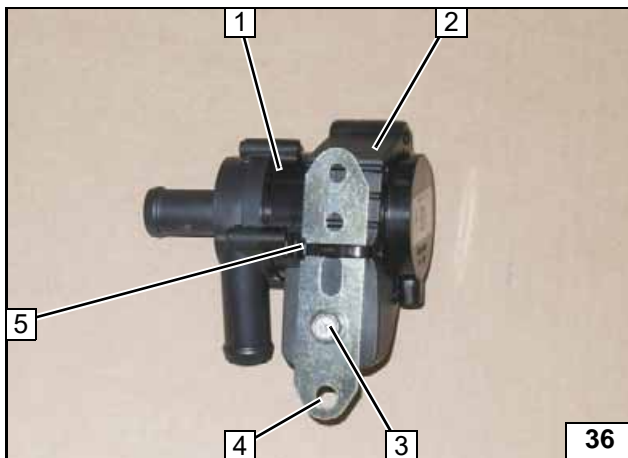

- 1 Circulating pump
- 2 Circulating pump mount
- 3 M6x25 bolt, perforated bracket, flanged nut
- 4 Drill out hole to 8.5 mm dia.
- 5 Cable tie

Premounting circulating pump

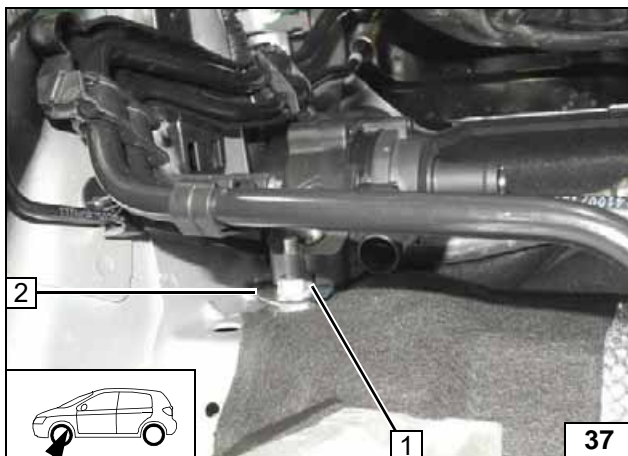

- 1 M8 flanged nut
- 2 Perforated bracket

Installing circulating pump

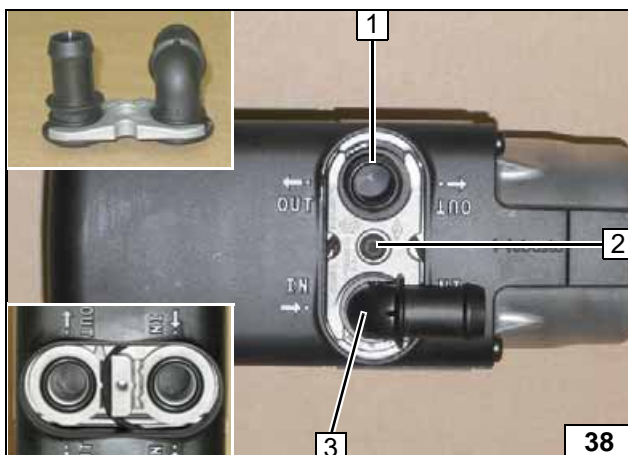

Preparing Heater



- 1 Axial water connection piece, sealing ring
- 2 5x15 self-tapping bolt, retaining plate of water connection piece
- 3 90° water connection piece, sealing ring

Installing water connection piece

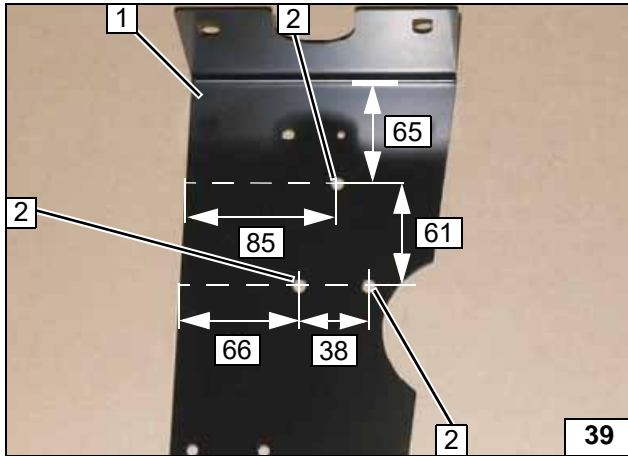
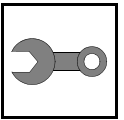

- 1 Bracket
- 2 6 mm dia. hole [3x]

Preparing bracket

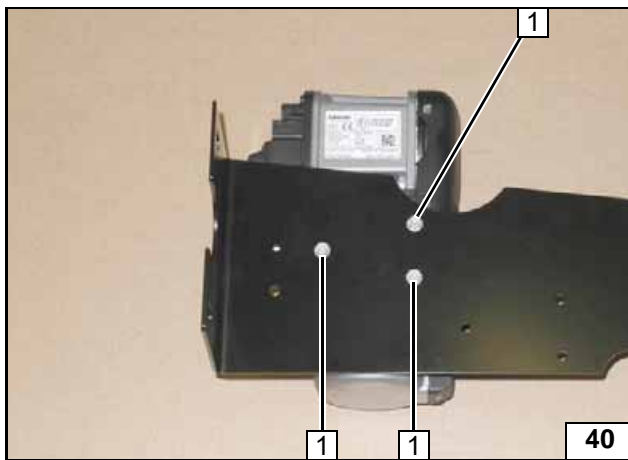

- 1 5x13 self-tapping bolt [3x]

Installing bracket

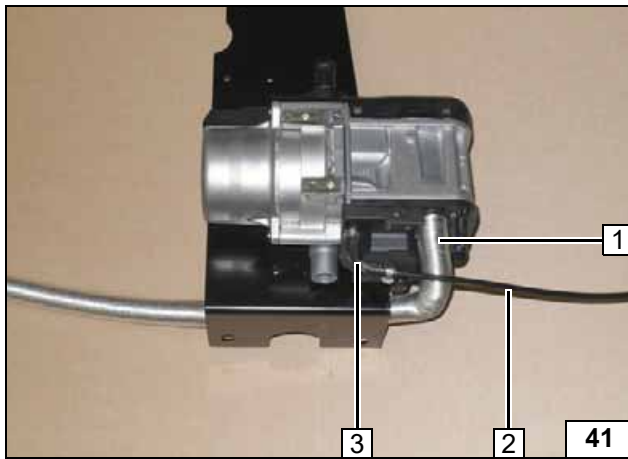

- 1 Combustion air pipe
- 2 Fuel line
- 3 90° moulded hose, 10 mm dia. clamp [2x]



Installing fuel line and combustion air pipe

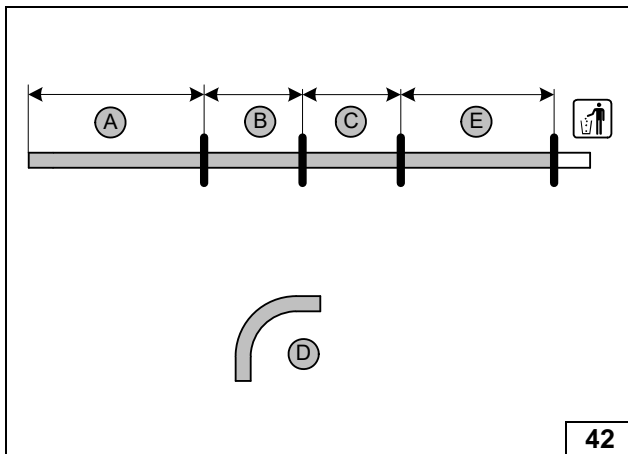

- A = 320
- B = 220
- C = 190
- E = 260

Cutting hoses to length

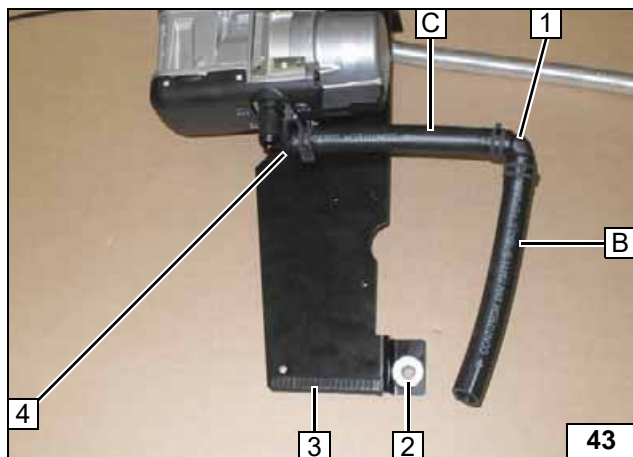
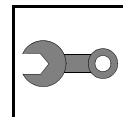

- 1 90°, 18x18 connecting pipe, 25 mm dia. spring clip [2x]
- 2 Rubber buffer with flanged sleeve
- 3 100mm edge protection
- 4 Heater inlet, 25mm dia. spring clip

Installing hose B and C

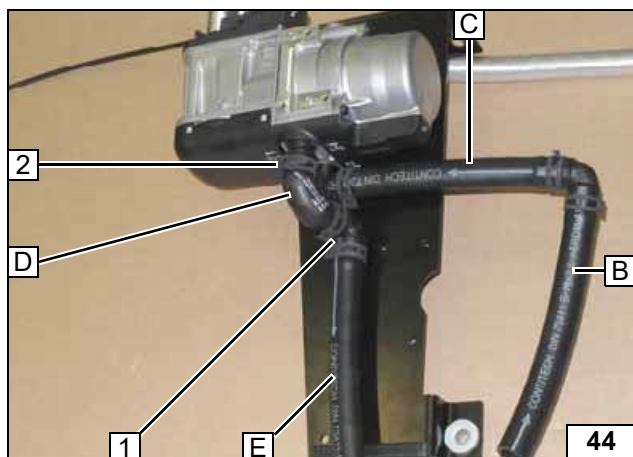

- 1 90°, 18x18 connecting pipe, 25 mm dia. spring clip [2x]
- 2 Spring clip = 25 mm dia.

Installing hose D and E

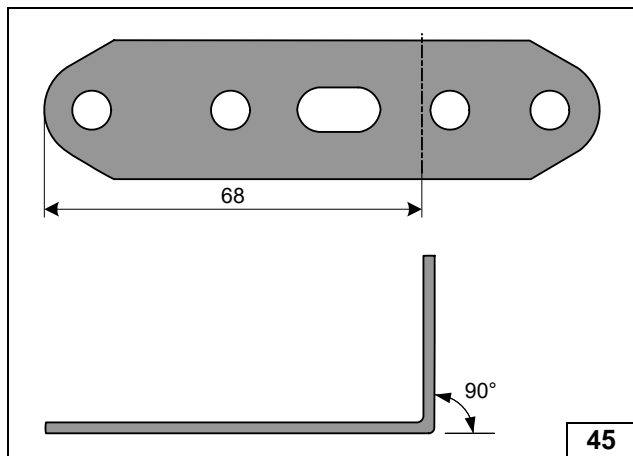

Angling down perforated bracket

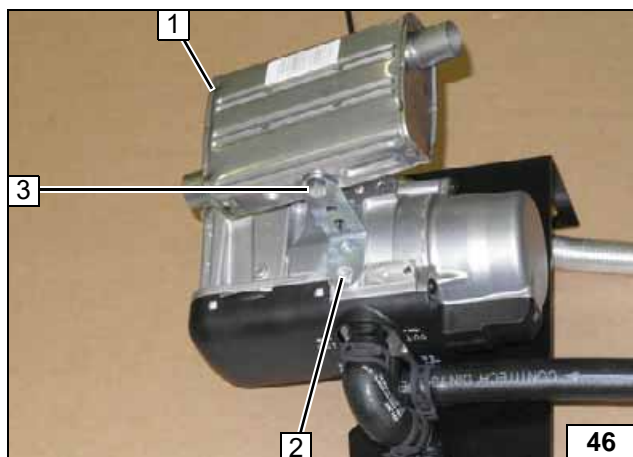

Loosely mount M6x16 bolt with spring lockwasher 3. Will be tightened later during the final work phase after aligning.

- 1 Exhaust silencer
- 2 5x13 self-tapping bolt



Installing exhaust silencer

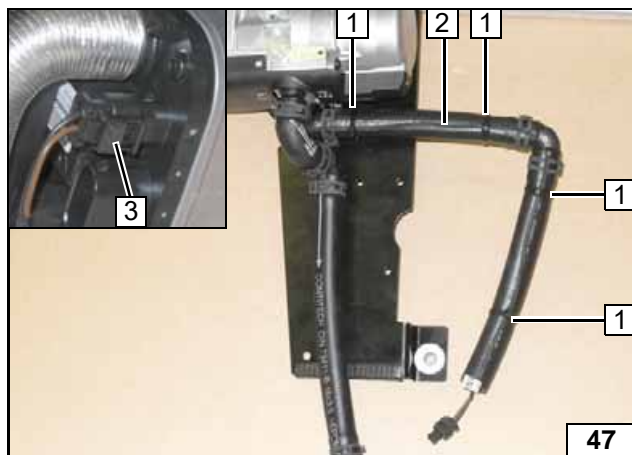
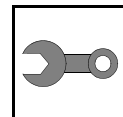

- 1 Cable tie [4x]
- 2 Wiring harness circulating pump
- 3 Connector of circulating pump wiring harness

Mounting circulating pump wiring harness

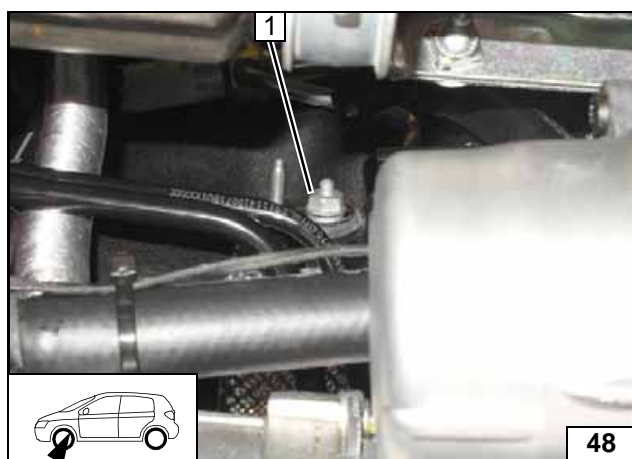

Installing Heater

- 1 M8 flanged nut, loosely mount large diameter washer



Installing heater

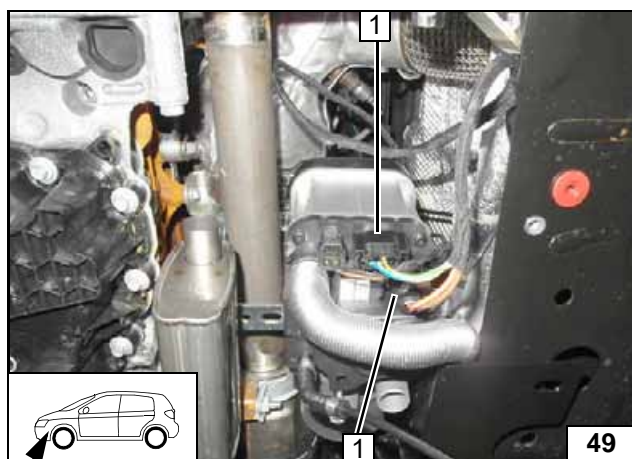

- 1 Connector of heater wiring harness [2x]

Installing heater wiring harness

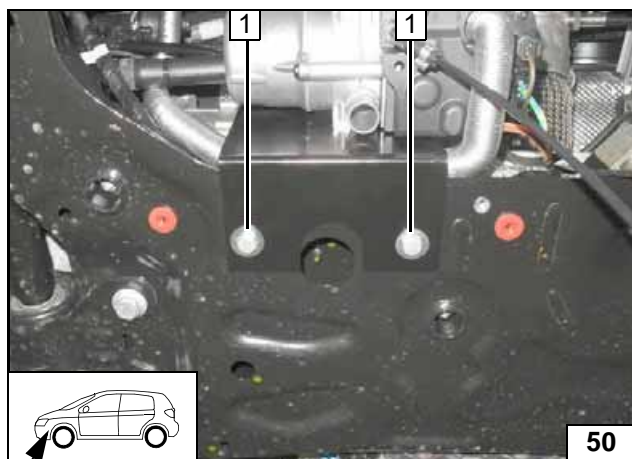

Focus

- 1 M8x20 bolt, large diameter washer, existing threaded hole [2x each]



C-Max and Grand C-Max

- 1 M8x20 bolt, large diameter washer, flanged nut [2x each]

Installing heater

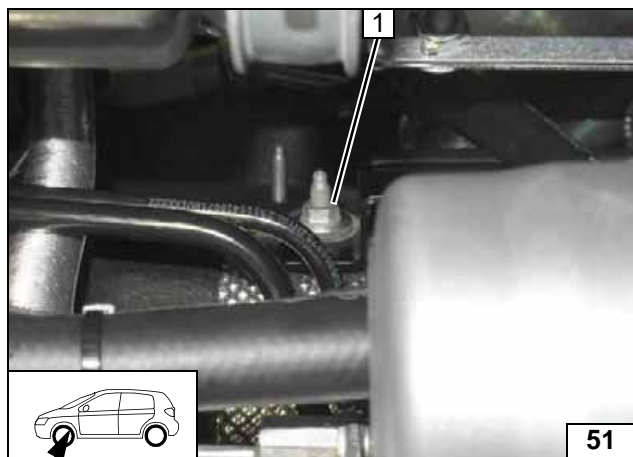
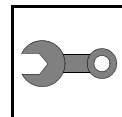

All vehicles

- 1 Tighten M8 flanged nut



**Installing
heater**



Fuel



Open the vehicle's fuel tank cap, ventilate the tank and then re-close the tank lock.

Catch any fuel running off in an appropriate container.



Route fuel line and metering pump wiring harness so that they are protected against stone impact. Unless specified otherwise, always fasten using cable ties.

Provide rub protection for fuel line and wiring harness in areas where there are sharp edges.

The fuel line and wiring harness are routed to the metering pump as shown in the wiring harness routing diagram.

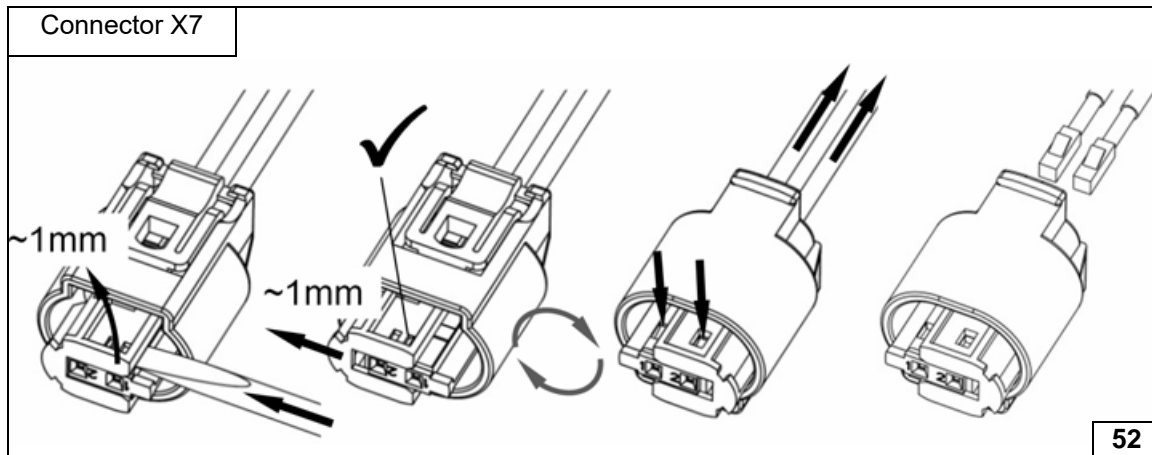

Dismantling metering pump connector

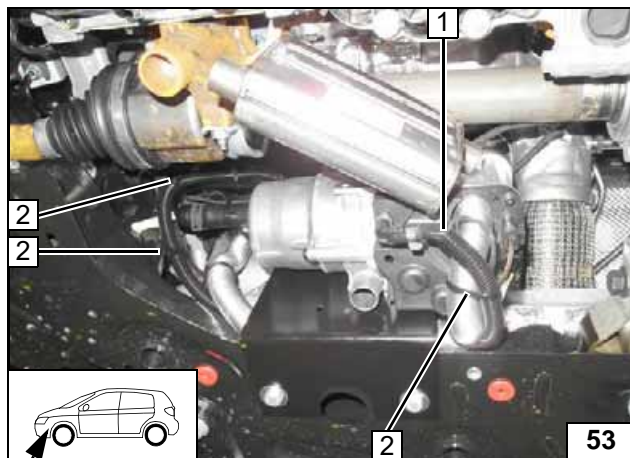

Route fuel line and wiring harness of metering pump in 10 mm dia. corrugated tube 1 along original vehicle fuel lines to underbody.

2 Cable tie [3x]

Routing lines

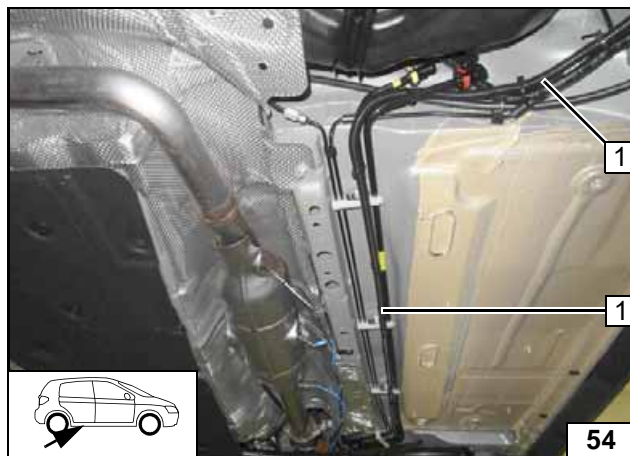

Route fuel line and wiring harness of metering pump in 10mm dia. corrugated tube 1 along original vehicle fuel lines to installation location of metering pump. Cut 1200mm from routed fuel line for fuel standpipe.

Routing lines

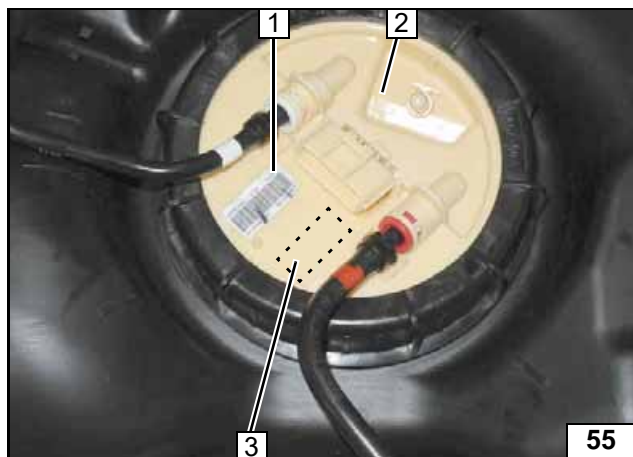

FuelFix Installation, Fuel Tank Sending Unit Version 1

Remove the fuel tank according to the manufacturer's instructions.

Work step F1.

Move label 1 to marked area 3 .

- 2 Fuel tank sending unit



Moving label

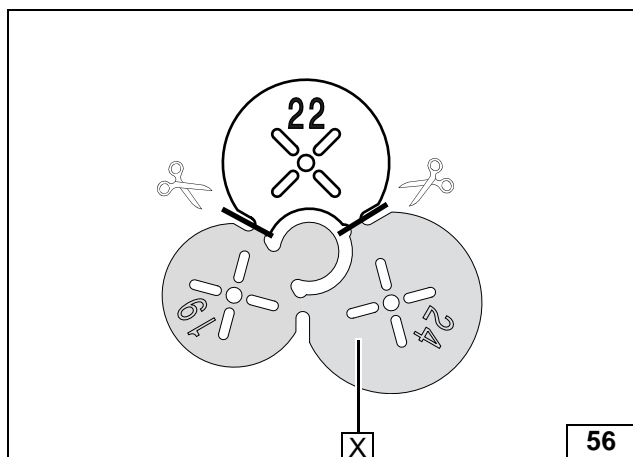

X =

Preparing drilling template

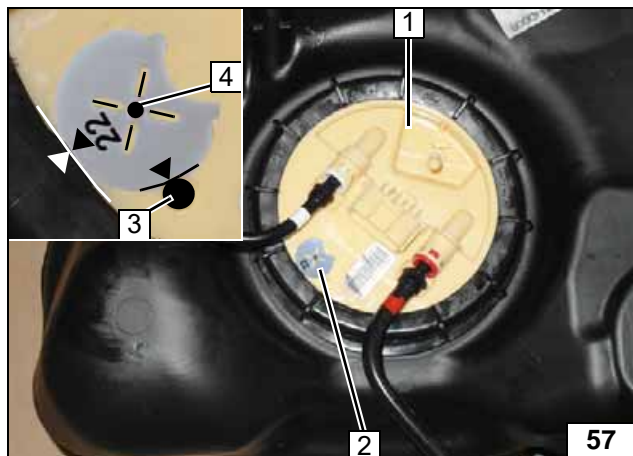

Work step F2.

- 1 Fuel tank sending unit
- 2 Position 22mm drilling template as shown
- 3 Contact point, outline traced
- 4 Hole pattern

Copying hole pattern



Work step F3.

- 1 Hole made with provided drill

Hole for FuelFix

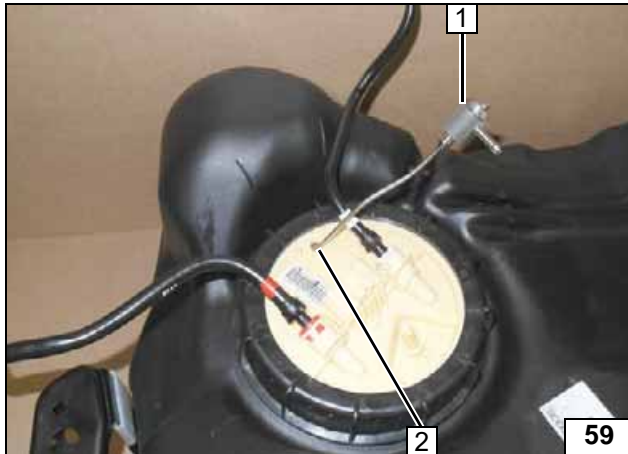
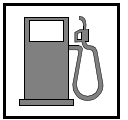

Work steps F4 and F5.

Bend FuelFix 1 according to template and cut to length.
Insert into hole 2.



**Inserting
FuelFix**



**Inserting
FuelFix**



**Inserting
FuelFix**

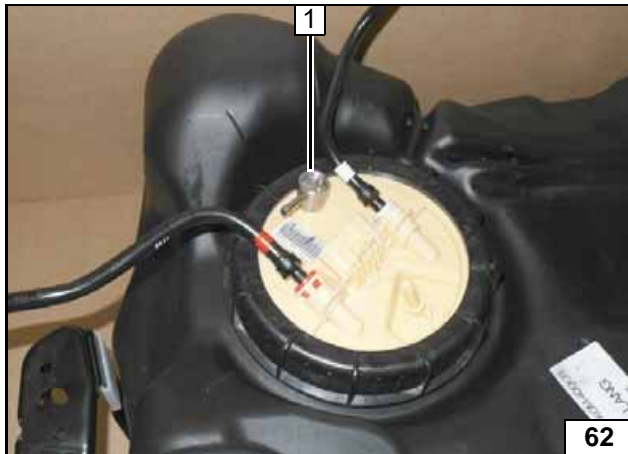

Work steps F5.3 and F5.4.

Align FuelFix 1 as shown.



**Aligning
FuelFix**

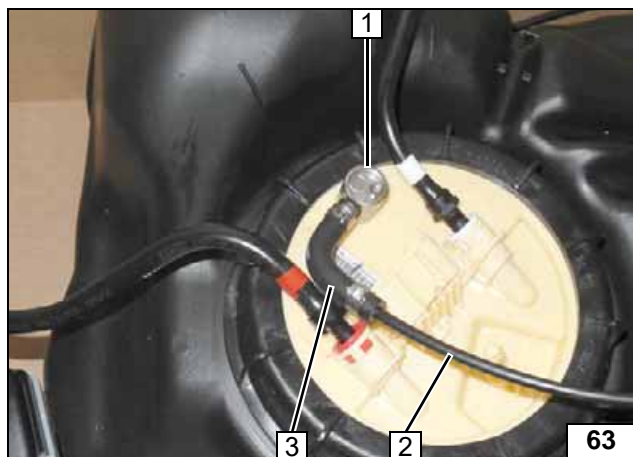
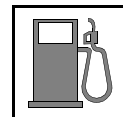

Work step F6.

- 1 FuelFix
- 2 1200mm fuel line
- 3 90° moulded hose, 10 mm dia. clamp [2x]



Connect-
ing fuel line

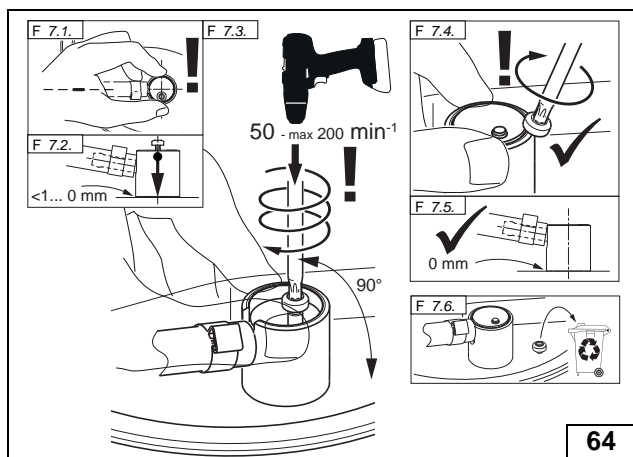

Work step F7.



Installing
FuelFix



Work step F8.

Ensuring
firm seating
of FuelFix

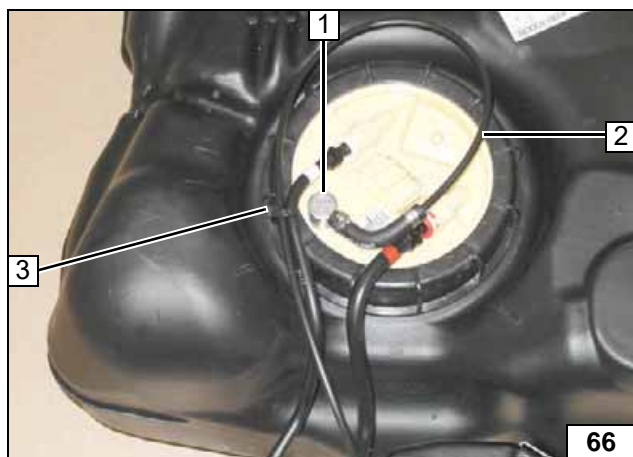

- 1 FuelFix mounted
- 2 Fuel line of FuelFix
- 3 Cable tie as tension relief



Securing
fuel line



Install fuel tank in accordance with manu-
facturer's instructions.

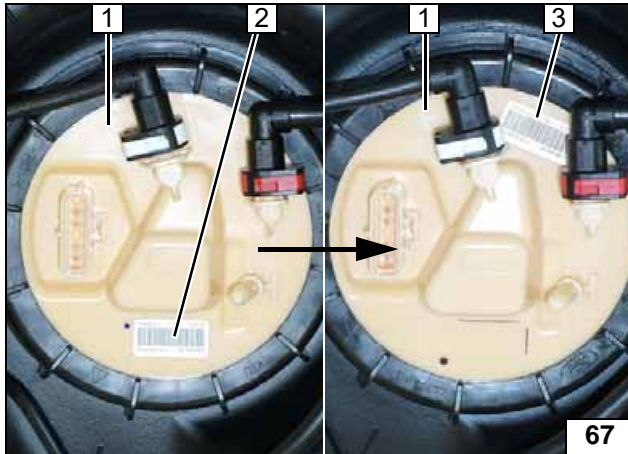

FuelFix Installation, Fuel Tank Sending Unit Version 2

Remove the fuel tank according to the manufacturer's instructions.

Work step F1.

- 1 Fuel tank sending unit
- 2 Label
- 3 Label moved



Moving label

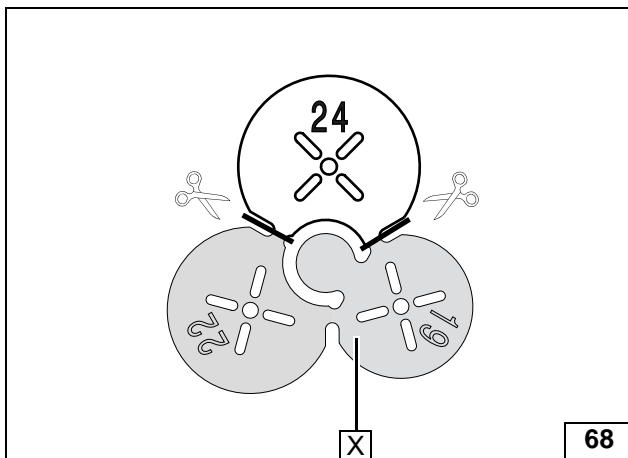

X=

Preparing drilling template

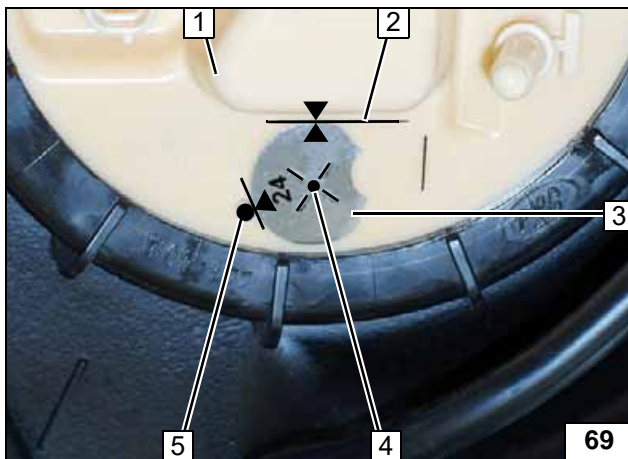

Work step F2.

- 1 Fuel tank sending unit
- 2 Contact line, outline traced
- 3 Position 24mm drilling template as shown
- 4 Hole pattern
- 5 Contact point, outline traced

Copying hole pattern

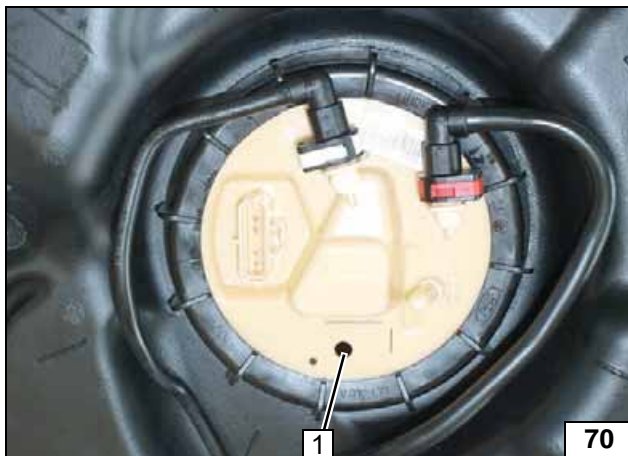

Work step F3.

- 1 Hole made with provided drill

Hole for FuelFix

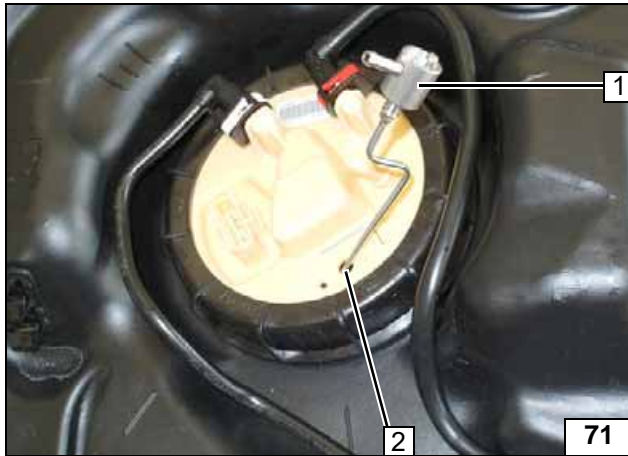
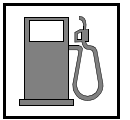

Work steps F4 and F5.

Bend FuelFix 1 according to template and cut to length. Insert into hole 2.



Inserting FuelFix



Inserting FuelFix



Inserting FuelFix

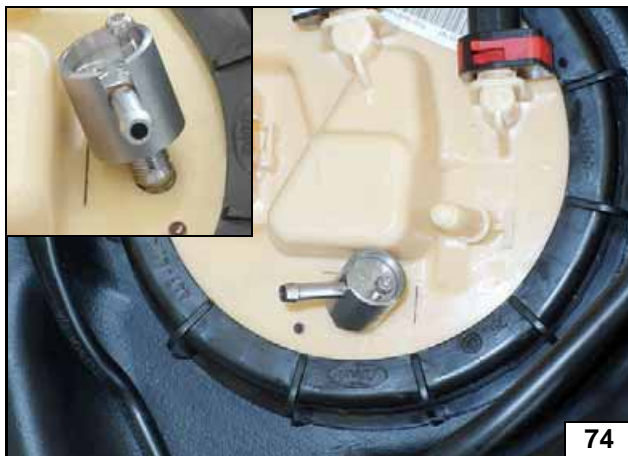

Inserting FuelFix

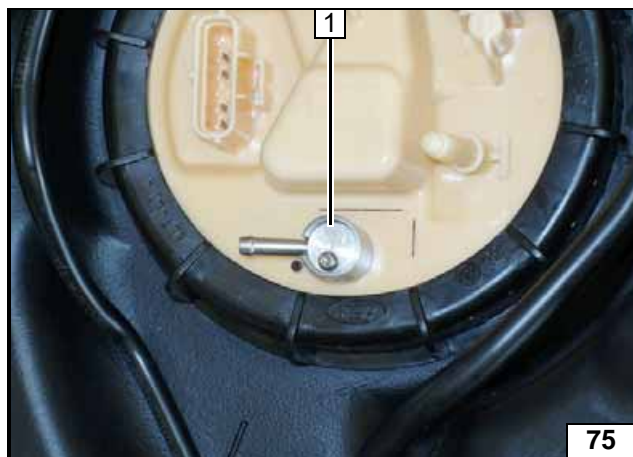

Work steps F5.3 and F5.4.

Align FuelFix 1 as shown.



Aligning FuelFix

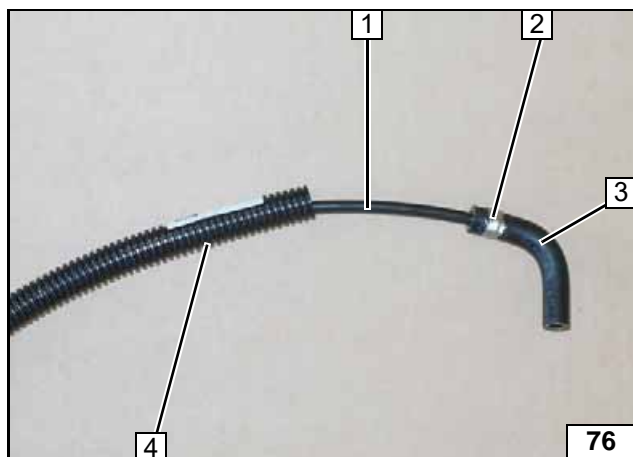

Work step F6.1.

- 1 1200mm fuel line
- 2 10 mm dia. clamp
- 3 90° moulded hose
- 4 10mm dia. corrugated tube

Premounting fuel line

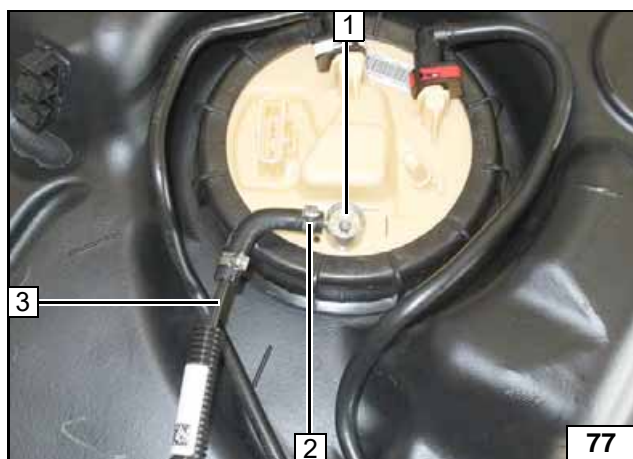

Work step F6.2.

- 1 FuelFix
- 2 10 mm dia. clamp
- 3 Fuel line premounted

Connecting fuel line

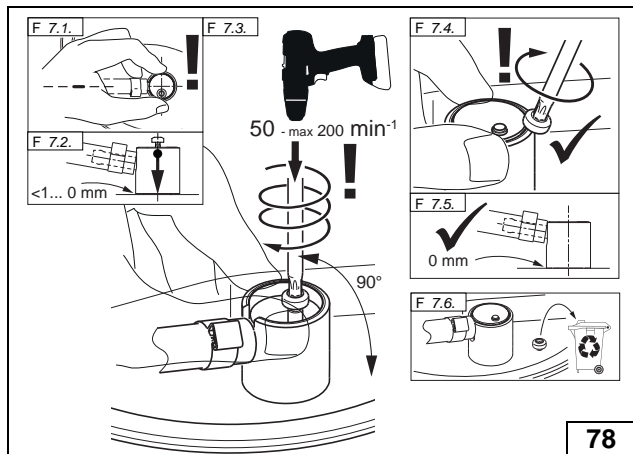

Work step F7.



Installing FuelFix



Work step F8.

Ensuring firm seating of FuelFix

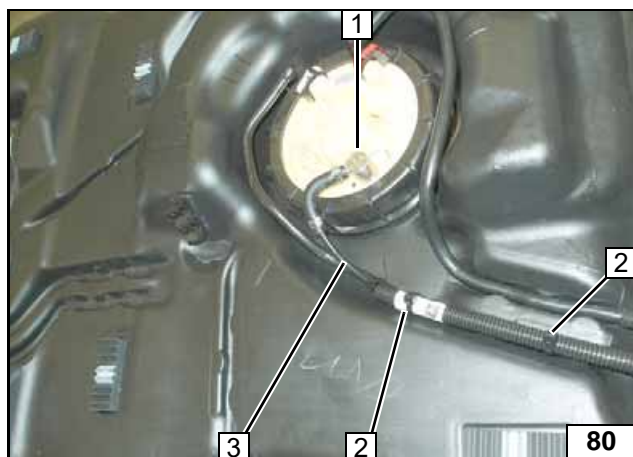

- 1 FuelFix mounted
- 2 Cable tie as tension relief [2x]
- 3 Fuel line of FuelFix

Securing fuel line



Install fuel tank in accordance with manufacturer's instructions.

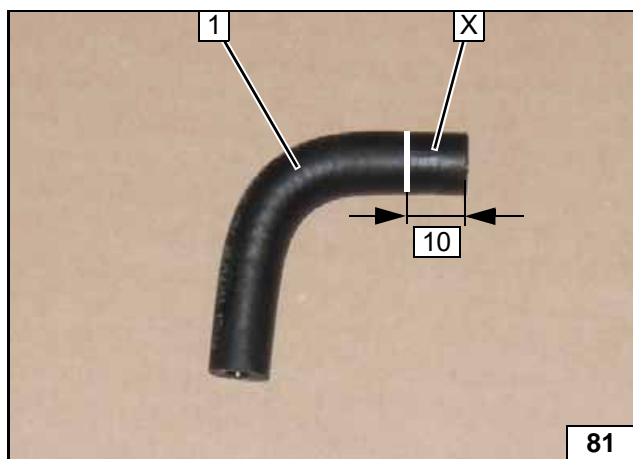

Focus and C-Max

- 1 90° moulded hose

X =



Cutting moulded hose to length

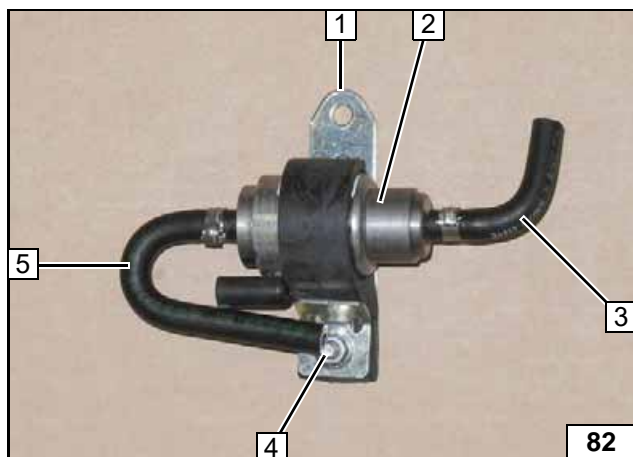

- 1 Perforated bracket
- 2 Metering pump
- 3 90° moulded hose (shortened side to metering pump), 10 mm dia. clamp
- 4 M6x25 bolt, perforated bracket 1, mounting of metering pump, support angle bracket, flanged nut
- 5 180° moulded hose, 10 mm dia. clamp

Premounting metering pump

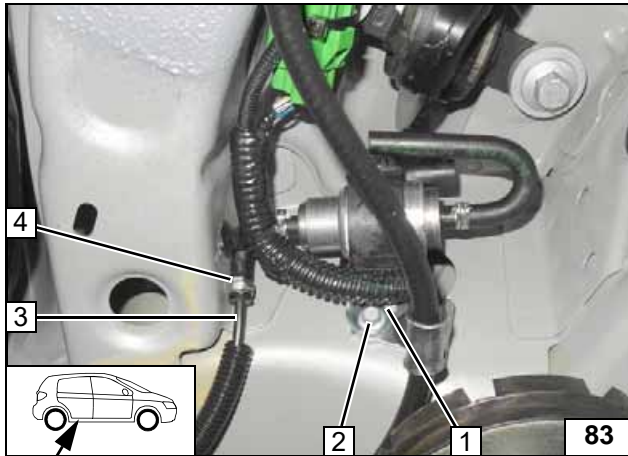
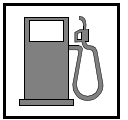

- 1 Premounted perforated bracket
- 2 Original vehicle bolt
- 3 FuelFix fuel line in corrugated tube
- 4 10 mm dia. clamp



Installing metering pump

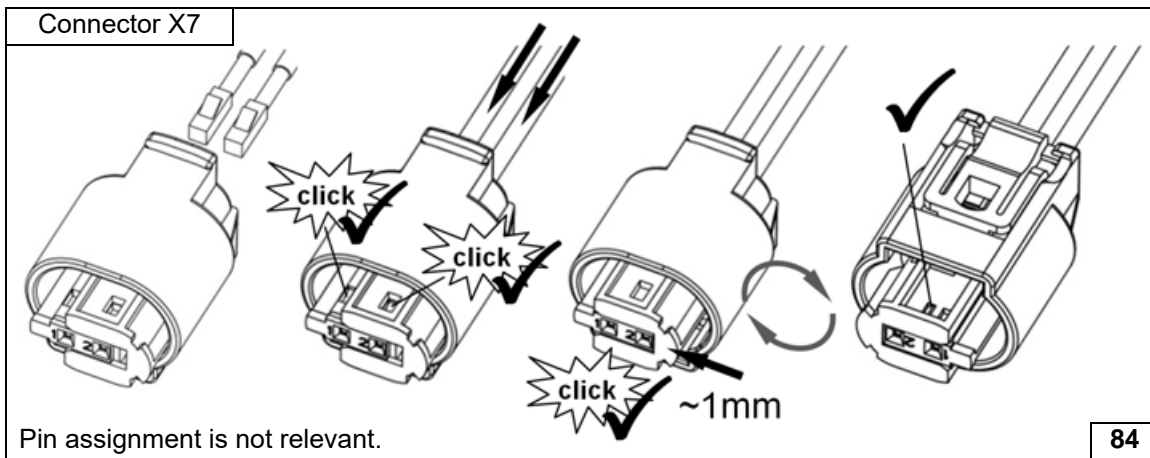

Completing metering pump connector

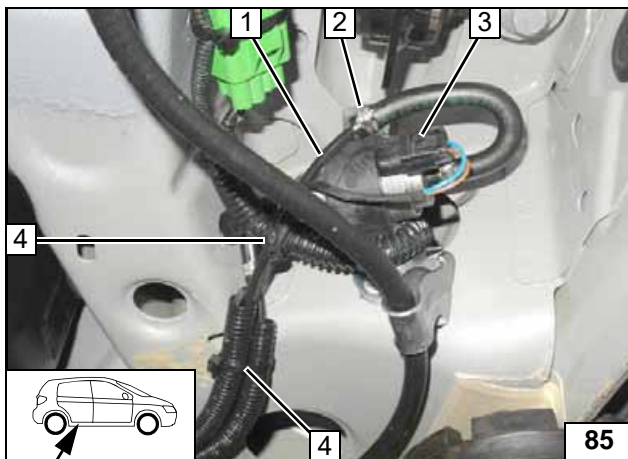

Check the position of the components; adjust if necessary. Check that they have freedom of movement.

- 1 Fuel line of heater
- 2 10 mm dia. clamp
- 3 Metering pump wiring harness, connector X7 mounted
- 4 Cable tie [2x]



Connecting metering pump

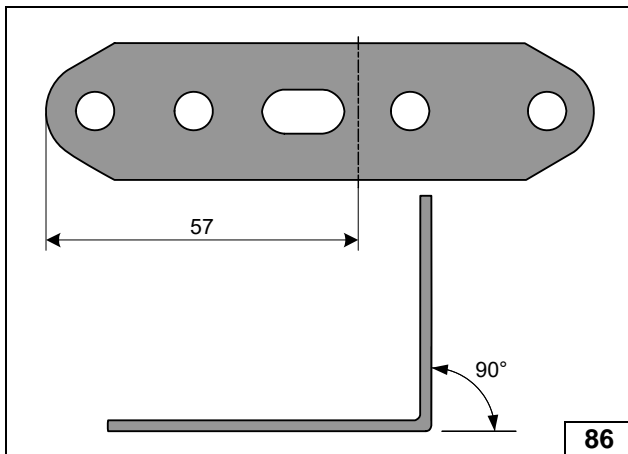

Grand C-Max



Angling down perforated bracket

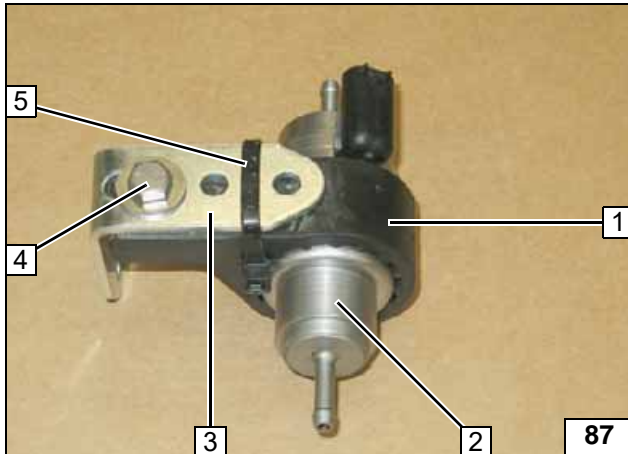

- 1 Metering pump mount
- 2 Metering pump
- 3 Perforated bracket
- 4 M6x25 bolt, washer, support angle bracket, flanged nut
- 5 Cable tie

Premounting metering pump

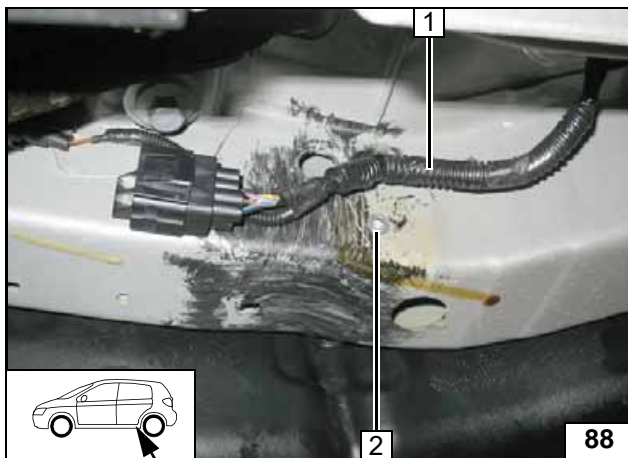

Detach retaining clip of original vehicle wiring harness 1 at position 2.

- 2 Drill out 9.1 mm dia. hole, rivet nut



Installing rivet nut

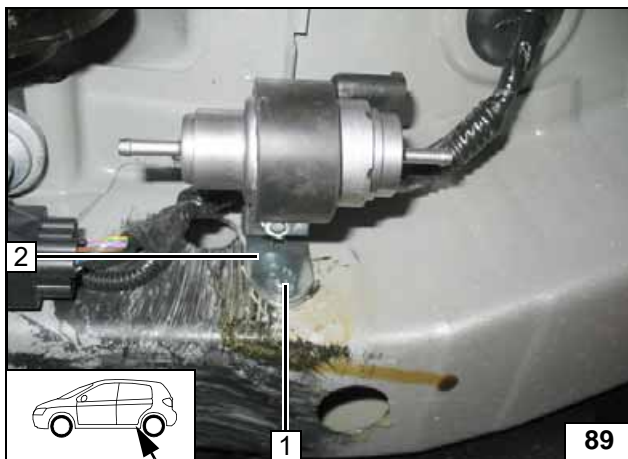

- 1 M6x20 bolt, spring lockwasher
- 2 Perforated bracket



Installing metering pump

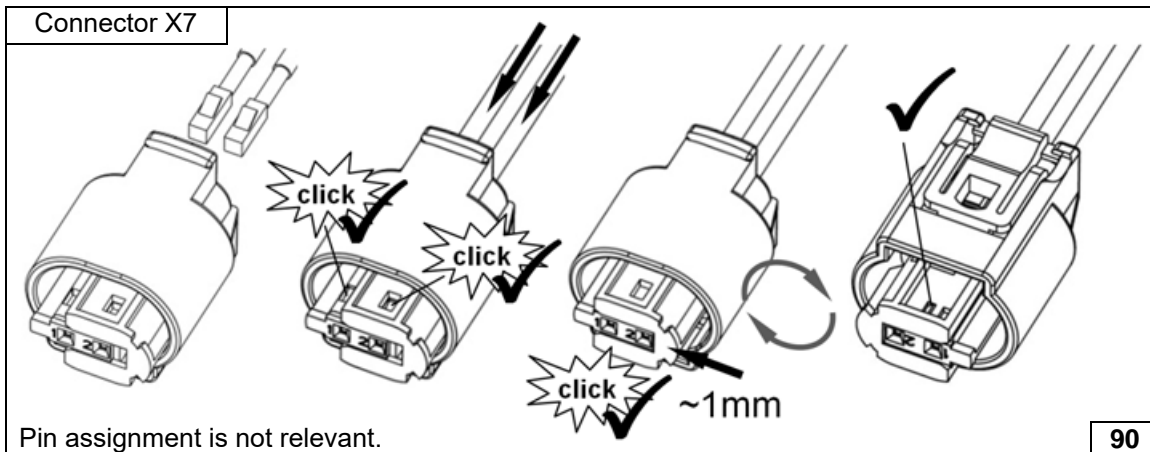

Pin assignment is not relevant.

Completing metering pump connector

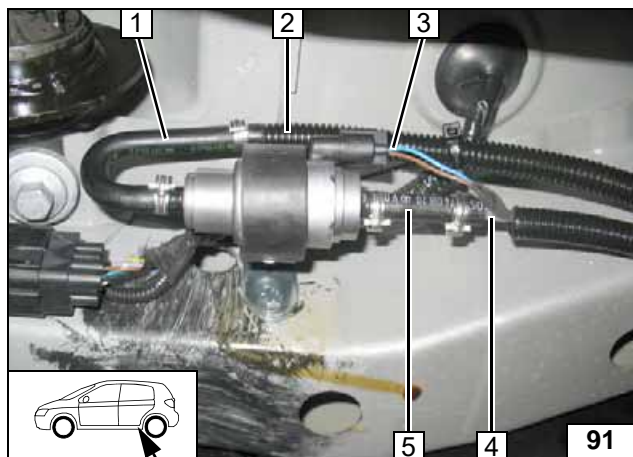

- 1 180° moulded hose, 10 mm dia. clamp [2x]
- 2 FuelFix fuel line in corrugated tube
- 3 Metering pump wiring harness, connector X7 mounted
- 4 Fuel line of heater
- 5 Hose section, 10mm dia. clamp [2x]



Connecting metering pump

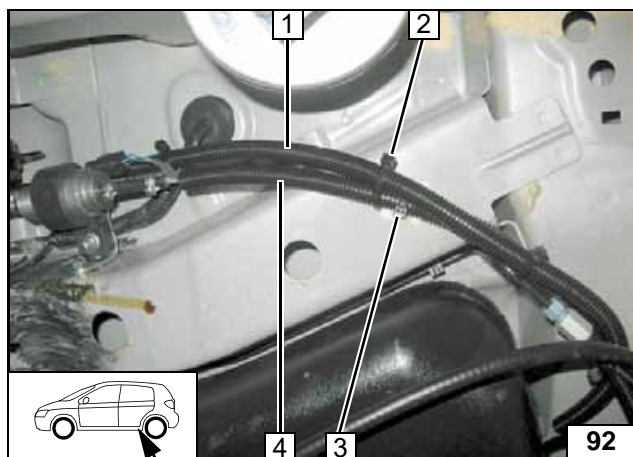

Check the position of the components; adjust if necessary. Check that they have freedom of movement.

- 1 FuelFix fuel line in corrugated tube
- 2 Cable tie
- 3 Adhesive base, cable tie
- 4 Fuel line of heater and wiring harness of metering pump in corrugated tube



Routing lines



Coolant Circuit



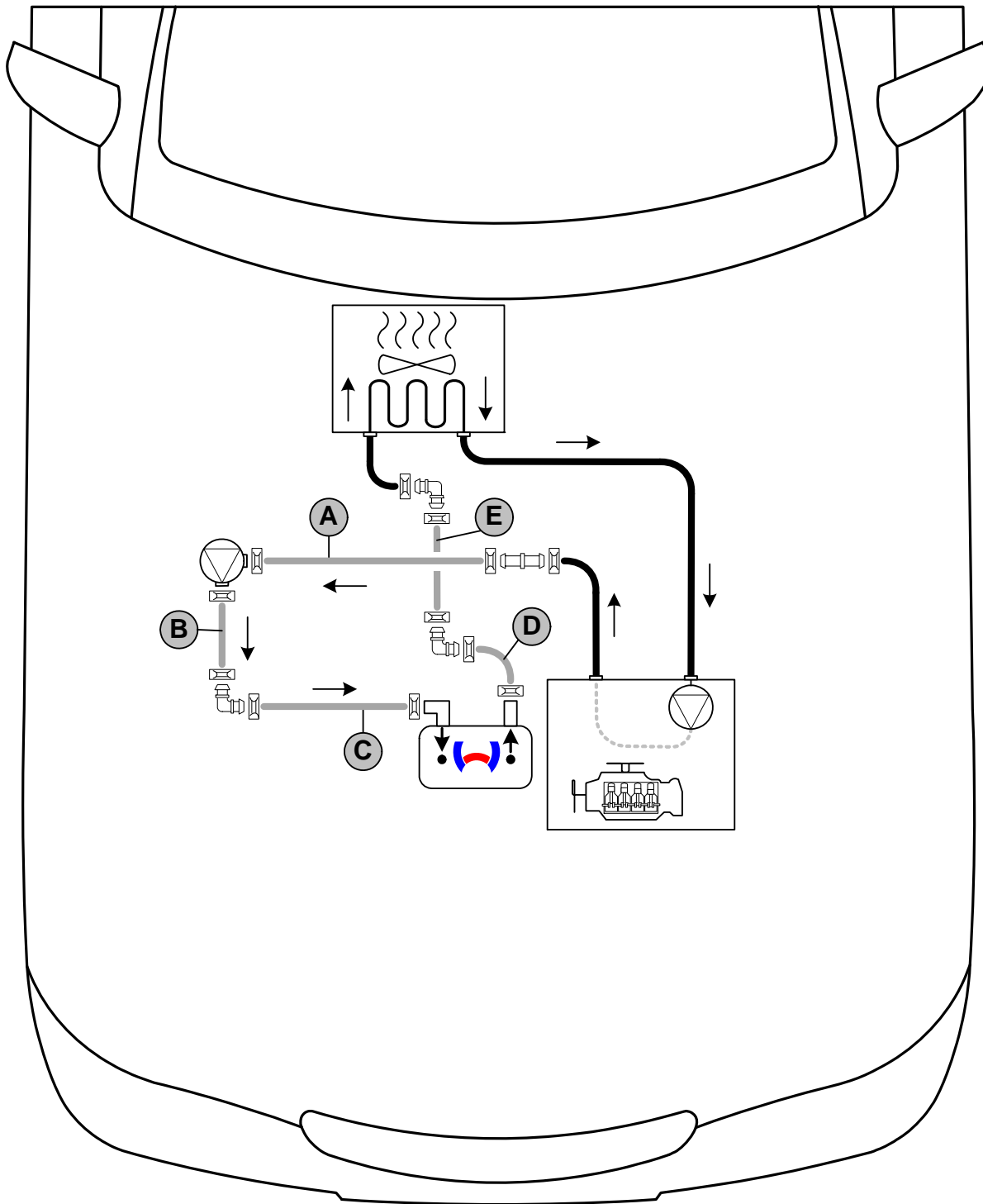

Any coolant running off should be collected in an appropriate container. Route hoses kink-free. Unless specified otherwise, always fasten using cable ties. Position clamps so that other hoses cannot be damaged. The heater must be filled with coolant when installing the hoses.

The connection should be modelled on an 'inline' circuit and based on the following diagram:



Hose routing diagram

All spring clips without a specific designation  = 25 mm dia.
 All connecting pipes  and  = 18x18mm dia.



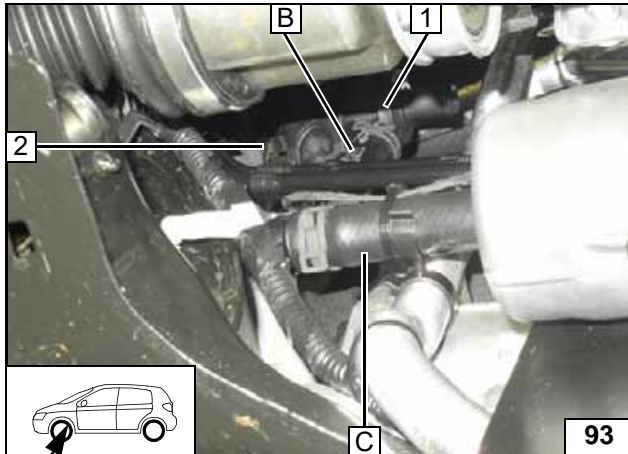

- 1 Circulating pump
- 2 Connector of circulating pump wiring harness

Connect-
ing circulat-
ing pump

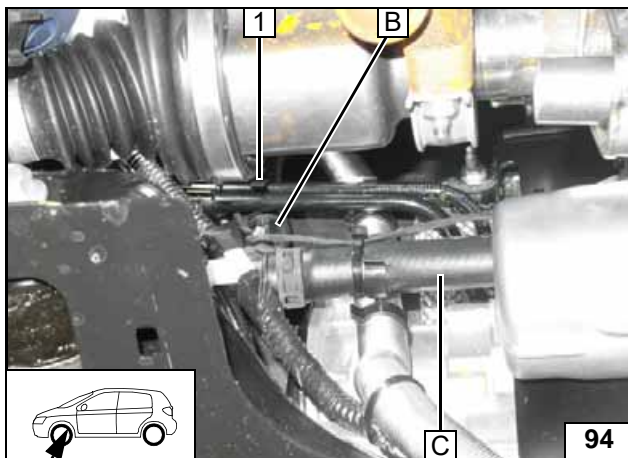

- 1 Hose bracket between hose B and original vehicle line

Installing
hose brack-
et

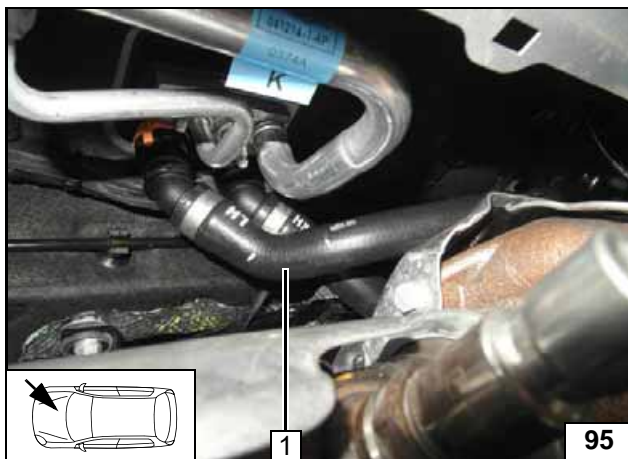

Disconnect hose of engine outlet / heat exchanger inlet 1 (see next figure).



Cutting
point



- 1 Engine outlet / heat exchanger inlet hose

View of
hose

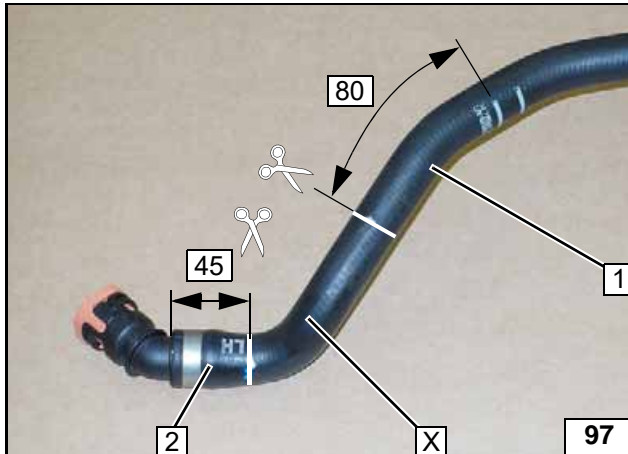
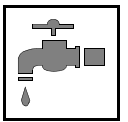

- 1 Heat exchanger inlet hose section
- 2 Engine outlet connecting piece

X =



Adapting hose

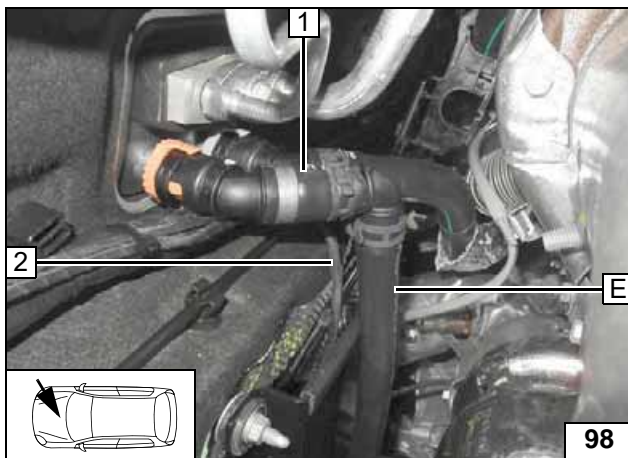

Fasten heater wiring harness 2 to hoses D and E up to the firewall using cable ties.

- 1 Heat exchanger inlet hose section



**Connect-
ing heat ex-
changer
inlet**

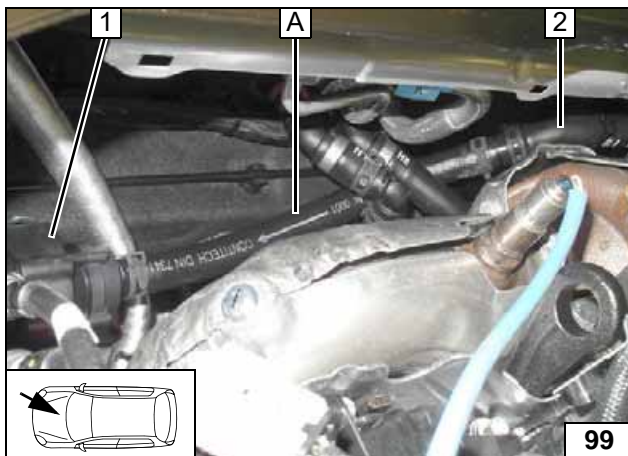

Align hoses. Ensure sufficient distance from neighbouring components, correct if necessary.

- 1 Circulating pump
- 2 Engine outlet hose section



**Connect-
ing engine
outlet**

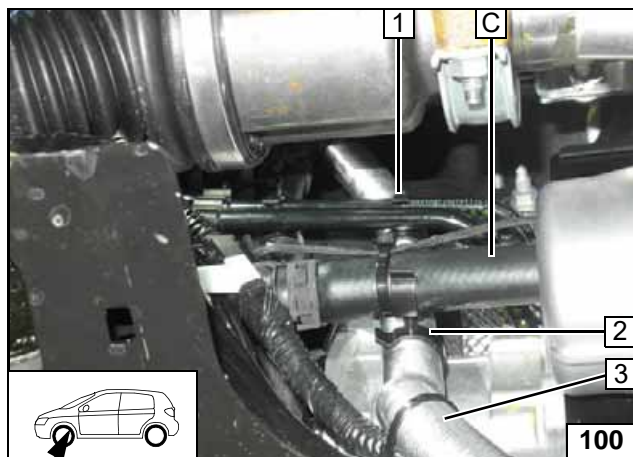
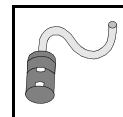

Combustion Air

- 1 22x9 hose bracket between combustion air pipe 3 and original vehicle line
- 2 22x22 hose bracket between combustion air pipe 3 and hose C



Routing combustion air pipe

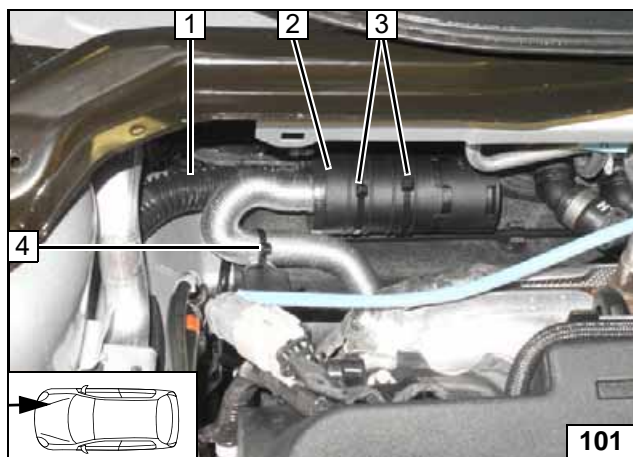

Fasten silencer 2 using cable ties 3 [2x] to original vehicle wiring harness 1.

- 4 Cable tie to perforated bracket of circulating pump



Installing silencer

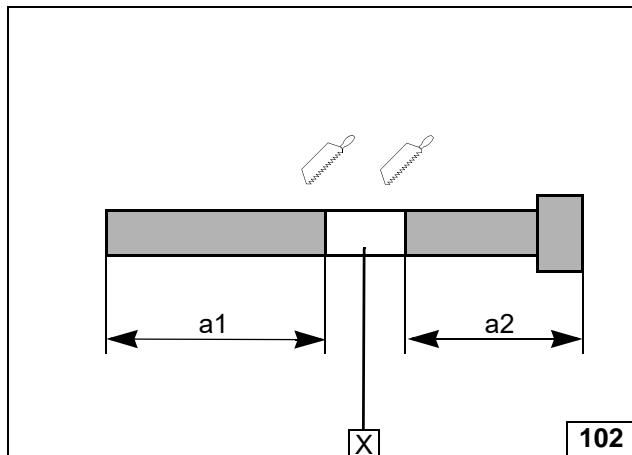
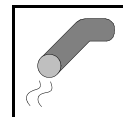

Exhaust Gas

a1 = 320

a2 = 250

X =

Preparing exhaust pipe

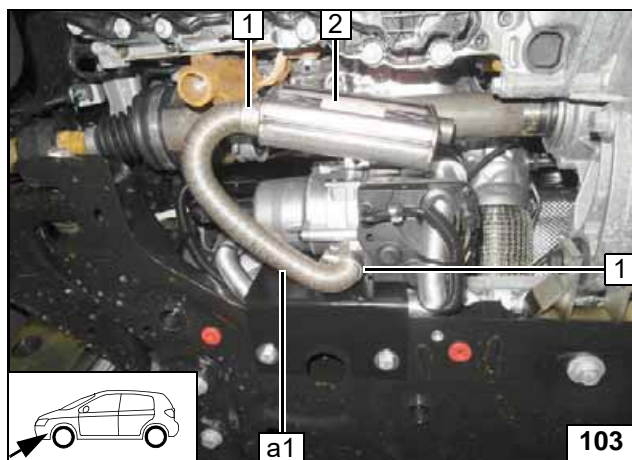

- 1 Hose clamp [2x]
- 2 Exhaust silencer

Installing exhaust pipe a1

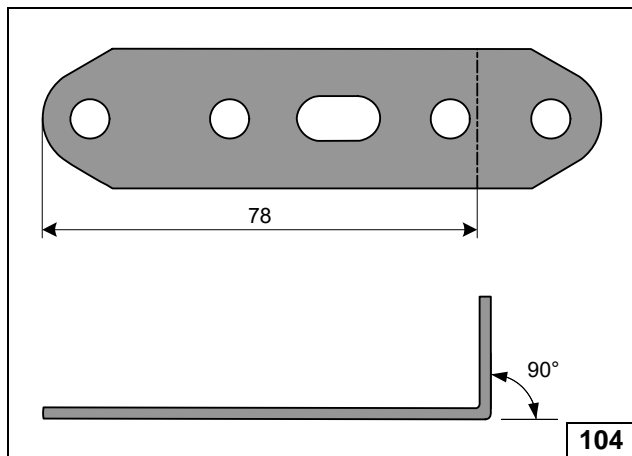

Angling down perforated bracket

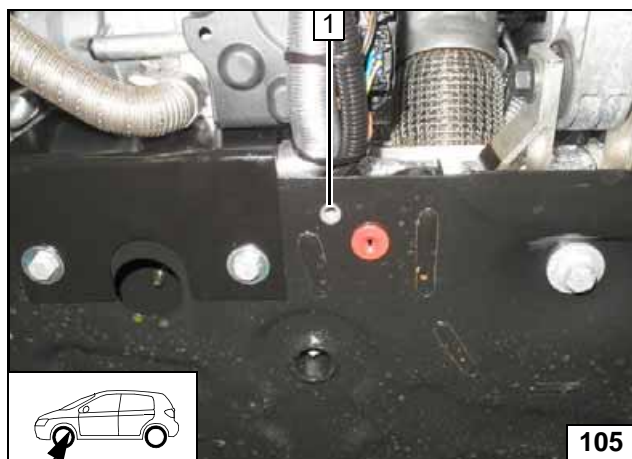

- 1 M6 rivet nut, existing hole

Mounting rivet nut

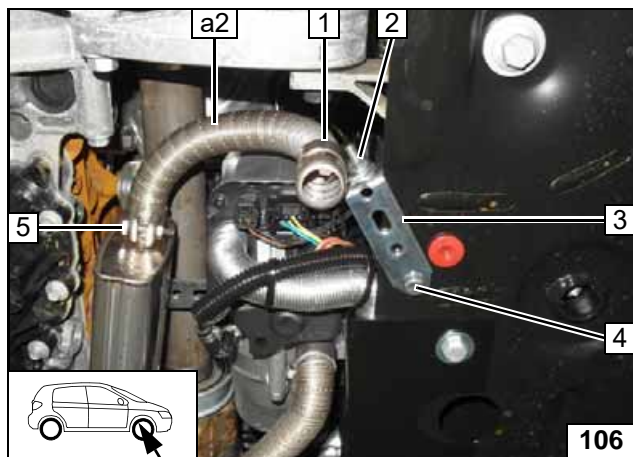
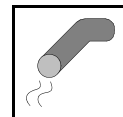

- 1 P-clamp
- 2 M6x20 bolt, flanged nut
- 3 Perforated bracket
- 4 M6x20 bolt, spring lockwasher
- 5 Hose clamp

Installing exhaust pipe a2

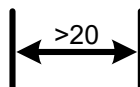
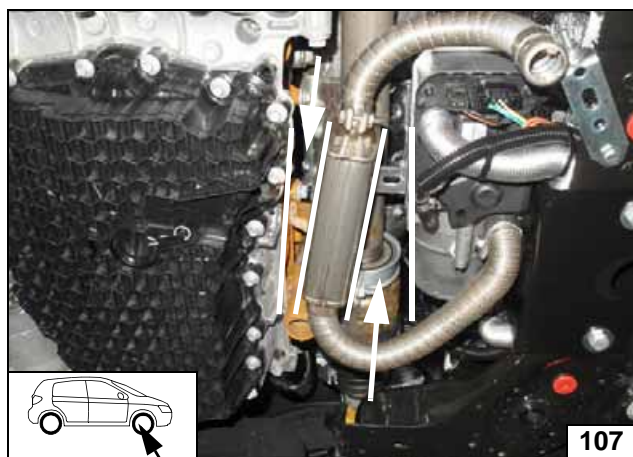

Tighten exhaust silencer after aligning.



Attaching exhaust pipe a2

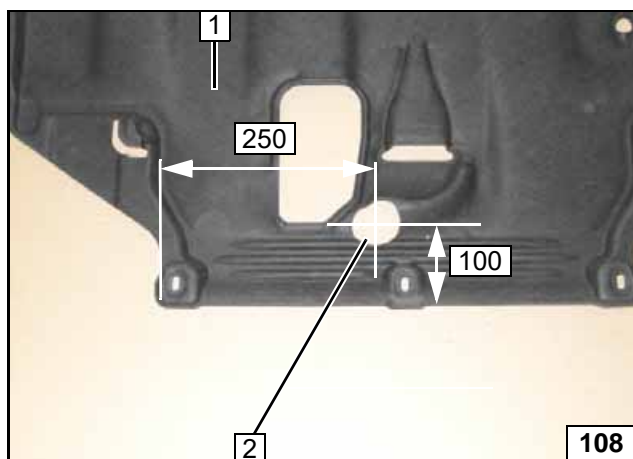

- 1 Underride protection
- 2 60 mm dia. hole

Cutting out underride protection

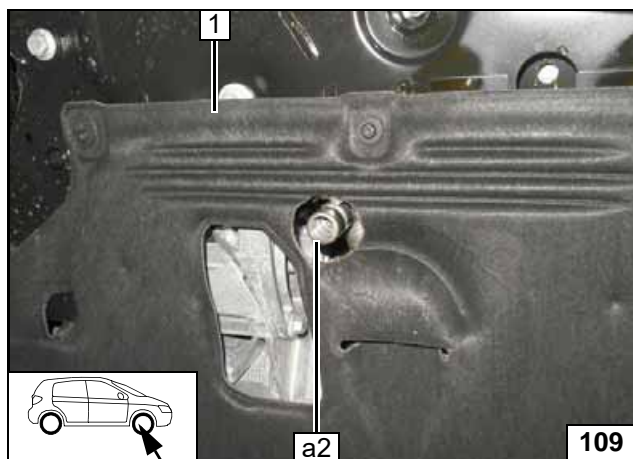

Mount underride protection of engine 1. Align exhaust pipe a2 flush with underride protection 1. Ensure sufficient distance from neighbouring components.



Aligning exhaust pipe a2

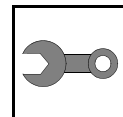

Final Work



Reassemble the components in reverse order. Check all hoses, clamps and all electrical connections for firm seating. Insulate and tie back loose lines. Only use manufacturer-approved coolant. Spray the heater components with anti-corrosion wax (Tectyl 100K).

- **Connect the battery.**
- **Fill and bleed the coolant circuit according to the vehicle manufacturer's instructions.**
- **Program MultiControl CAR, teach Telestart transmitter.**
- **In case of manual air-conditioning make settings on the A/C control panel according to the 'Operating Instructions'.**
- **In case of automatic air-conditioning, if the fan function or A/C control panel settings need to be checked, see the installation documentation in the additional kit 'Webasto Standard' or 'Webasto Comfort' A/C control, section 'Final Work'.**
- **Place the 'Switch off parking heater before refuelling' caution label near the filler neck.**
- **For initial startup and function check, please see installation instructions.**





FuelFix Template for Fuel Tank Sending Unit Version 1

Top view

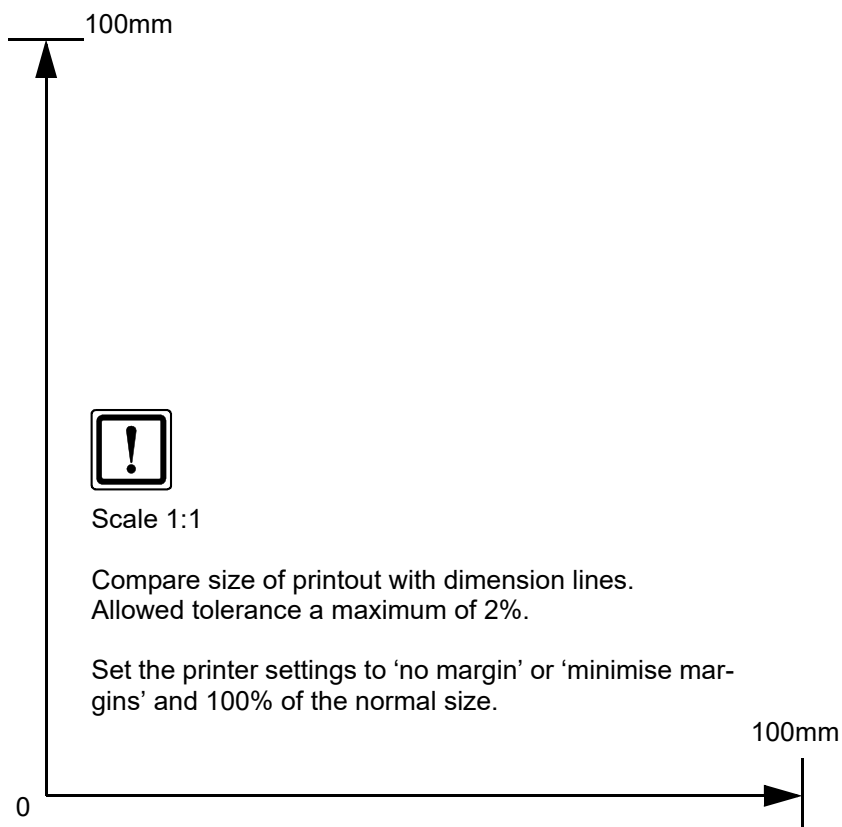
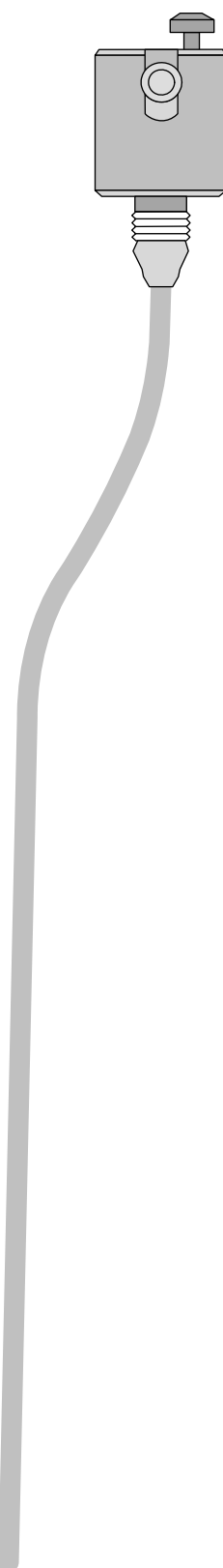
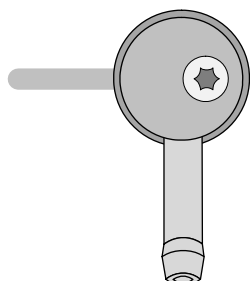



FuelFix Template for Fuel Tank Sending Unit Version 2

Top view

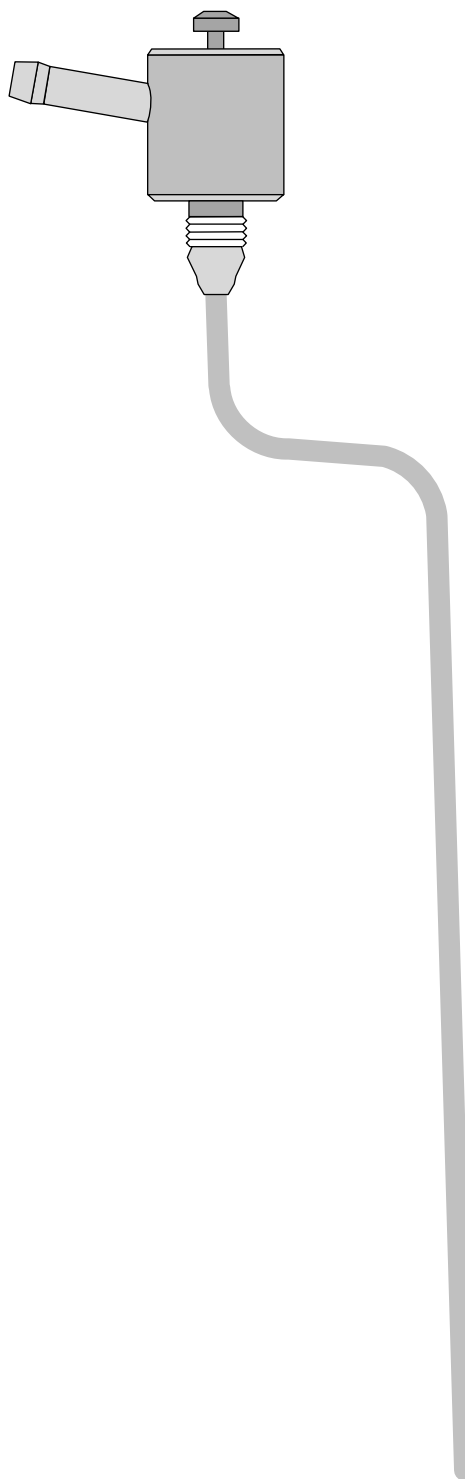
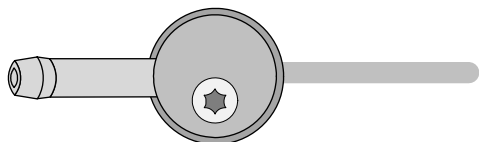

100mm



Scale 1:1

Compare size of printout with dimension lines.
Allowed tolerance a maximum of 2%.

Set the printer settings to 'no margin' or 'minimise margins' and 100% of the normal size.

100mm

0

Operating Instructions for Focus with Man. A/C

Please remove page and add to the vehicle operating instructions.

Note:

We recommend matching the heating time to the driving time.

Heating time = driving time

Example:

For a driving time of approx. 20 min. (in one direction), we recommend not exceeding a switch-on time of 20 min.

Passenger compartment monitoring, if installed, must be deactivated in addition to the vehicle settings for the heating operation.

For instructions on deactivation, please refer to the operating instructions of the vehicle.

Before parking the vehicle, make the following settings:

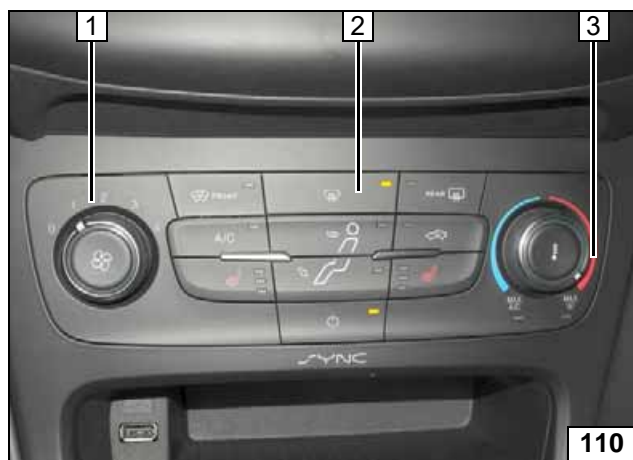

- 1 Set fan to level '1', or max. '2'
- 2 Air outlet to windscreen
- 3 Set temperature to 'max.'

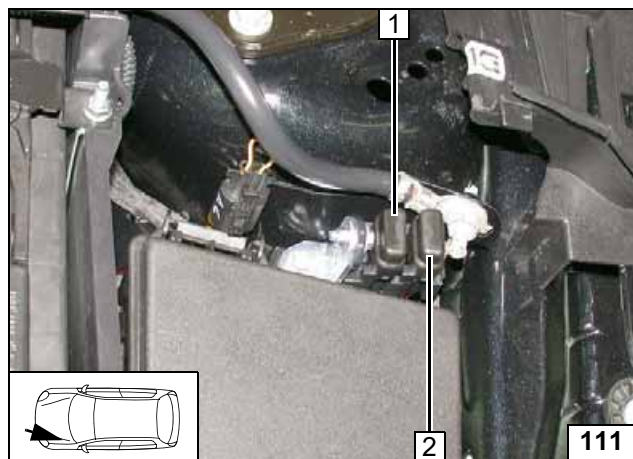

- 1 30A passenger compartment main fuse F2
- 2 20A heater fuse F1

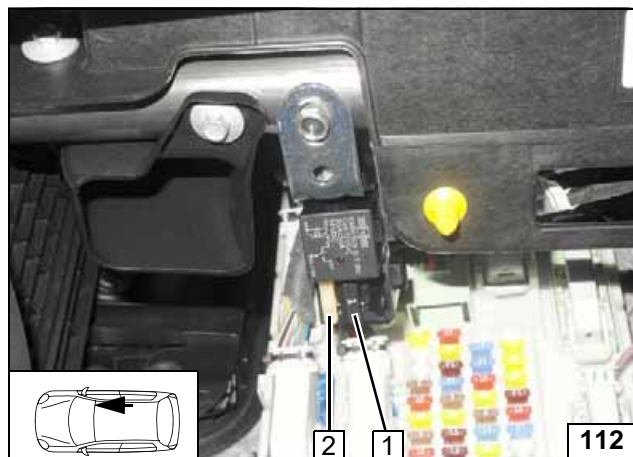

- 1 1A heater control fuse F3
- 2 25A fan fuse F4



A/C control panel

Engine compartment fuses

Passenger compartment fuses

Operating Instructions for C-Max / Grand C-Max with Man. A/C

Please remove page and add to the vehicle operating instructions.

Note:

We recommend matching the heating time to the driving time.

Heating time = driving time

Example:

For a driving time of approx. 20 min. (in one direction), we recommend not exceeding a switch-on time of 20 min.

Passenger compartment monitoring, if installed, must be deactivated in addition to the vehicle settings for the heating operation.

For instructions on deactivation, please refer to the operating instructions of the vehicle.

Before parking the vehicle, make the following settings:

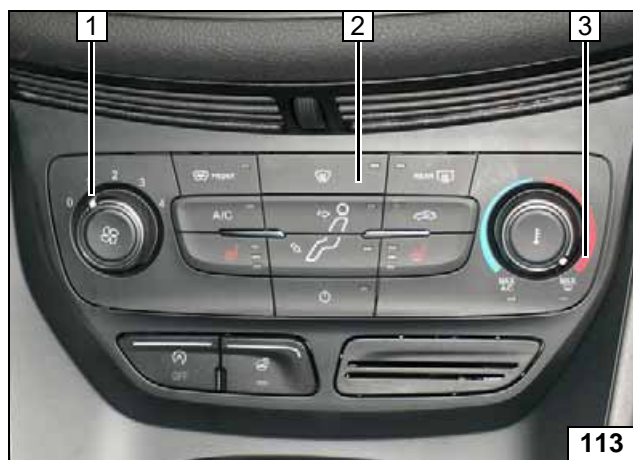

- 1 Set fan to level '1', or max. '2'
- 2 Air outlet to windscreen
- 3 Set temperature to 'max.'



A/C control panel

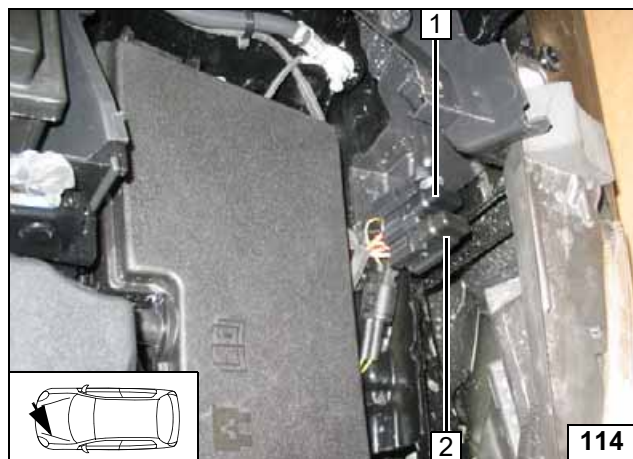

- 1 30A passenger compartment main fuse F2
- 2 20A heater fuse F1

Engine compartment fuses

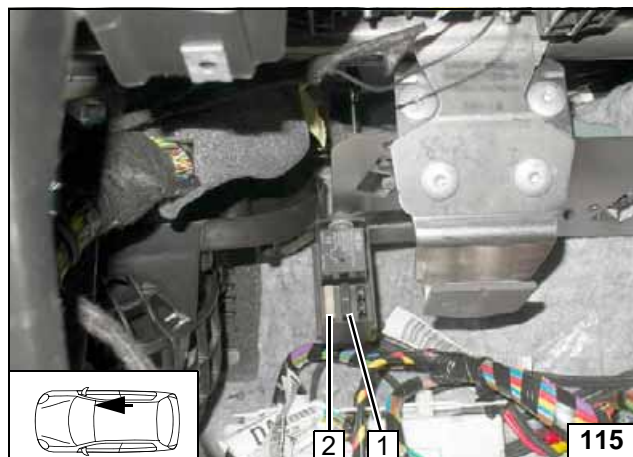

- 1 1A heater control fuse F3
- 2 25A fan fuse F4

Passenger compartment fuses

