

Water heater



Feel the drive

Thermo Top E additional heating system

Thermo Top - Z/C additional heating system

Approval code ~~~ S 316 / ~~~ S 292

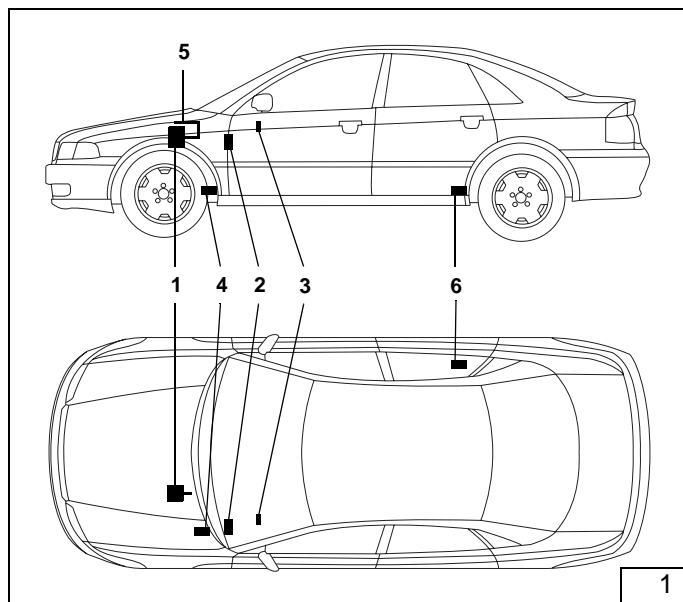

Installation instructions

Audi A4

1.8T petrol

Left-hand drive models only

All equipment versions

Tested vehicles, see page 2

The vehicle types, engine types and equipment versions not listed in these installation instructions have not been tested.

It may nevertheless be possible to install the system using these installation instructions.

Compliance with the licensing regulations set out on page 2 is essential.

NOTE:

An application for the general model licence (ABG) has been submitted to the German Federal Department of Transport but the licence has not yet been issued.

Legend for Figure 1

- 1 Thermo Top Z/C-B or E-B heater
- 2 Blade-type fuse holder and blower relay
- 3 Digital timer
- 4 Exhaust silencer
- 5 Combustion air intake line
- 6 Dosing pump

Table of contents

Audi A4	1
Heater / Installation kit	2
Validity	2
Foreword	2
Special tools	3
General information	3
Preparations	3
Installation site for the heater	4
Blade-type fuse holder and blower relay	4
Digital timer and optional summer/winter switch	9
To install the heater	10
Combustion air intake line	11
Integration in the water system	12
Integration in the fuel system	15
Exhaust system	20
Exhaust passage	22
Concluding work	22
Operating instructions for the end customer	23

Heater / Installation kit

Quantity	Description	Order No.
1	Water heater <i>Thermo Top E - B</i> or 1Water heater <i>Tele Thermo Top E - B</i> or 1Water heater <i>Thermo Top Z/C - B</i> or	668 90A 670 84A 906 04A
1	Water heater <i>Tele Thermo Top Z/C - B</i>	670 83A

Also required:

1	Audi A4 installation kit <i>Thermo Top Z/C/E-B</i>	13 007 56A
---	--	------------

Validity

Manufacturer	Type	Trade name	EC licence No.
Audi AG		Audi A4	e1*98/14*0151*..

Engine code	Engine type	Output in kW	Displacement in cc
AVJ	Petrol	110	1781

Foreword

These non-binding installation instructions apply to the Audi A4 1.8l Turbo petrol version (see cover sheet for validity) model year 2001 and later, unless technical modifications on the car influence the installation, excluding all liability claims. Depending on the version and equipment in the car, changes may be required to the installation work set out in these installation instructions. In any event, however, the directives in the “installation manual” and “operating manual” **Thermo Top Z/C/E** must be followed. The appropriate engineering conventions must be observed for the installation work.

IMPORTANT

The licensing regulations must be observed!

In the Federal Republic of Germany, retrofitting the Thermo Top Z/C additional heating systems using these installation instructions must be approved since the general operating licence (ABG) does not feature a special supplement. The system must be installed as set out in the installation manual. It must be tested

- a) in the type test of the cars pursuant to §20 of the German Road Traffic Act,
- b) in the individual test pursuant to §21 of the German Road Traffic Act or
- c) in the assessment pursuant to §19 of the German Road Traffic act by an officially approved expert or tester for the motor trade, a motor vehicle expert or employees as described in section 4 of Appendix VIIIb to the German Road Traffic Act

and in case c) this must be certified, quoting the vehicle manufacturer, model and vehicle identification number on the approval confirmation. The validity of the model licence depends on this.

Special tools

- Clamping claw
- Torque wrench for 2.0 – 10 Nm
- Torx E5 nut

Special Audi tools

- Clamping pliers V.A.G. 1275
- Tool to open the locking ring on the fuel tank fittings

General information

- Bare body parts, for example around drilled holes, must be treated with anti-corrosive coating.
- Secure hoses, cables and wiring harnesses with cable ties and fit protective hoses around them at chafing points
- Fit edge protectors (opened fuel hose) to sharp edges

Preparations

- Remove the inapplicable year number from the duplicate plate
- Fit the duplicate plate (model plate) in a suitable position where it is visible

Exterior

- Open the filler cap, release the pressure from the fuel tank system and close the filler cap again
- Remove the underride guard
- Remove the underbody guard on the right in full
- Remove both front wheel arch trims
- Remove the propeller shaft cover on the right

Under-bonnet compartment

- Remove the engine cover

IMPORTANT

Disconnect the battery!

- Remove the battery
- Open the radiator cap and release the pressure
- Close the radiator cap again
- Release the coolant expansion tank and move it to one side
- Remove the radiator tank cover
- Remove the top windscreen washer tank

Interior

- Remove the rear seat bench
- Remove the bottom dashboard trim on the driver side
- Remove the sill / sill covers on the left
- Remove the service flap from the tank fittings
- Release the central electrical system
- Remove the air-conditioning control module
-

Installation site for the heater

The heater (2/1) is to be installed on the side member between the engine and the ABS unit as shown in Figure 2. It is installed horizontally and longitudinally along the vehicle's length.

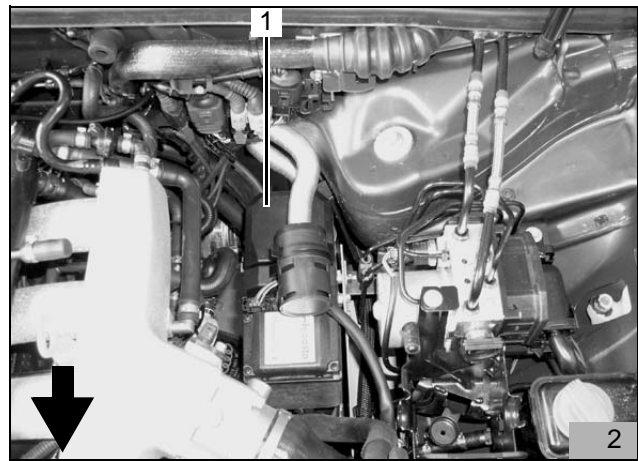

Blade-type fuse holder and blower relay

To prepare the wiring harness

- Cut the br cable (3/6; 4/6) 1.5 mm² from the earth post to the dosing pump
- Cut the bl cable (3/7,8; 4/3,4,5) from the heater to the dosing pump
- Cut the br cable (3/9; 4/3) 2.5 mm² from the earth post to the heater
- Cut the rd cable (3/2; 4/1) 4.0 mm² from the fuse holder to the heater
- Cut the gn/wt cable (3/1; 4/2) 0.75 mm² from blower relay K3 to the heater
- Cut the rd cable (3/3; 4/10) 0.75 mm² from the fuse holder to the digital timer
- Cut the br cable (3/5; 4/9) 0.75 mm² from the earth post to the digital timer at plug X9
- Cut the br cable (3/4; 4/8) 0.75 mm² from the earth post in the digital timer wiring harness (3/10; 4/7)

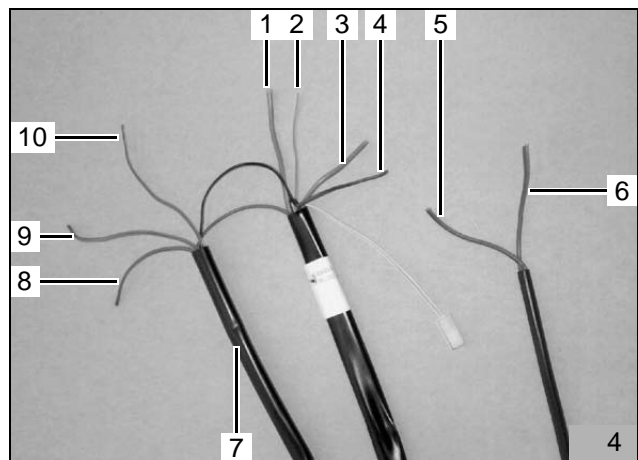
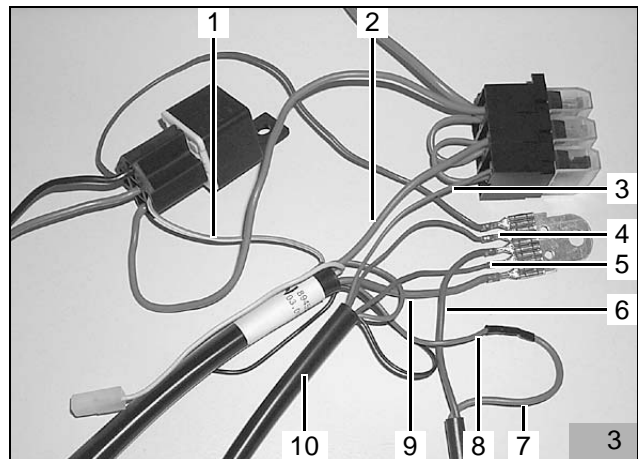

- Remove the rd cable (5/3) 2.5 mm² from the fuse holder to blower relay K3
- Remove the br cable (5/2) 0.75 mm² from the earth post to blower relay K3
- Remove the bl cable (5/1) 2.5 mm² from blower relay K3
- Remove the rd cable (5/7) 2.5 mm² from blower relay K3
- Remove the earth post (5/5)
- Remove blower relay K3 (5/6) complete with its bracket
- Remove the fuse holder (5/4)

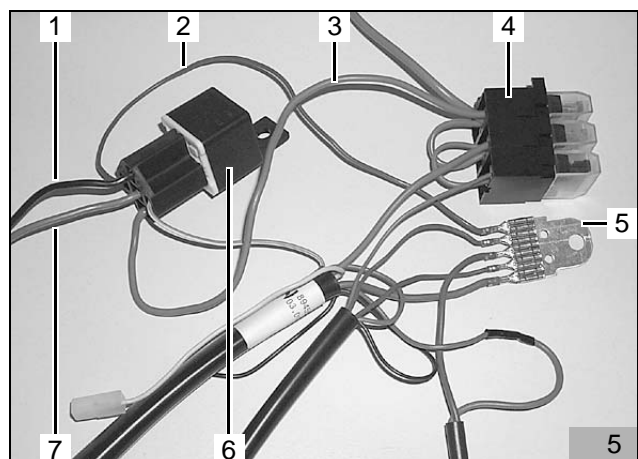

- Connect the prepared heater wiring harness (6/1,2; 7/3) to the heater (6/3) as shown in Figure 6

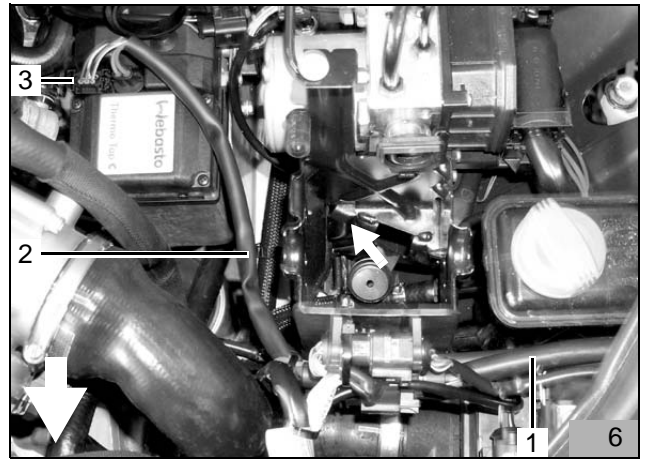

- Lay the heater wiring harness (7/3) as shown in Figure 2 and Figure 3 along the standard wiring harness (7/2) in the wheel arch to the passage hole (7/1) and into the interior.

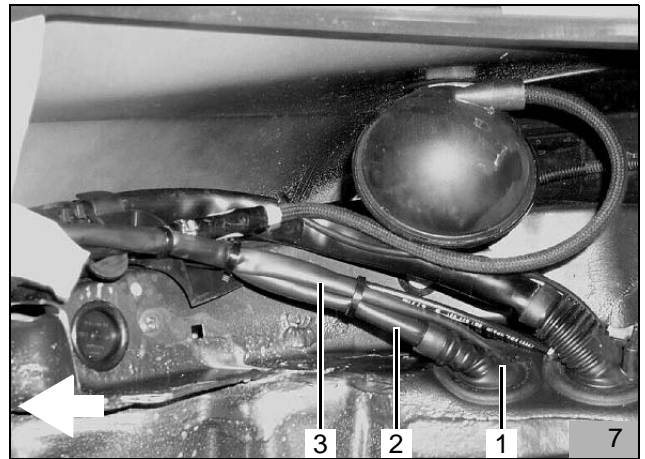

- Lay the digital timer wiring harness (8/2) starting with plug X9 through the passage hole (7/1) and into the interior
- Follow it with the heater wiring harness (8/1; 7/3) as shown in Figure 7

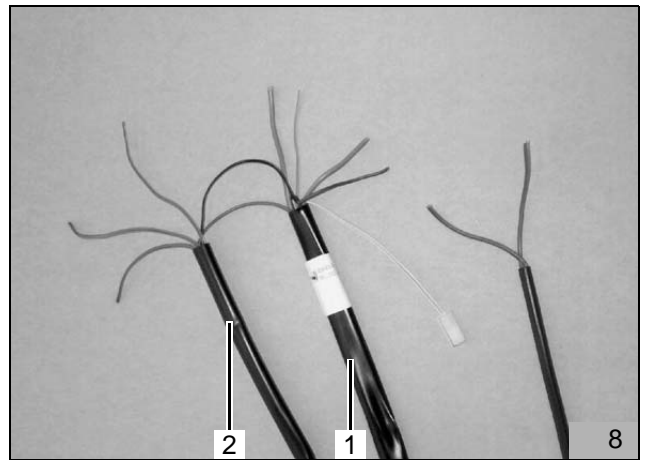

- Lay the heater wiring harness (9/1; 8/1) as shown in Figure 9 to the central electrical system

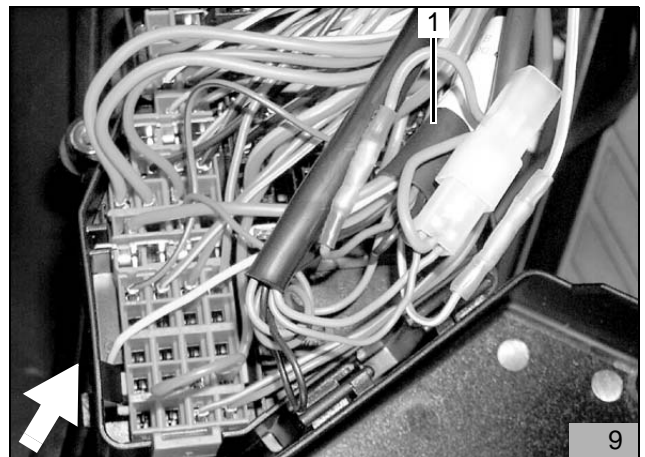

- Connect the bl cable (10/6) from the heater and the bl cable (10/2) to the dosing pump with butt connectors (10/1) as shown in Figure 10 (squeeze and shrink)
- Connect the gn/wt cable (10/5) from the heater to the enclosed gn/wt cable (10/3) with butt connectors (10/4) as shown in Figure 10 and Figure 11 (squeeze and shrink)

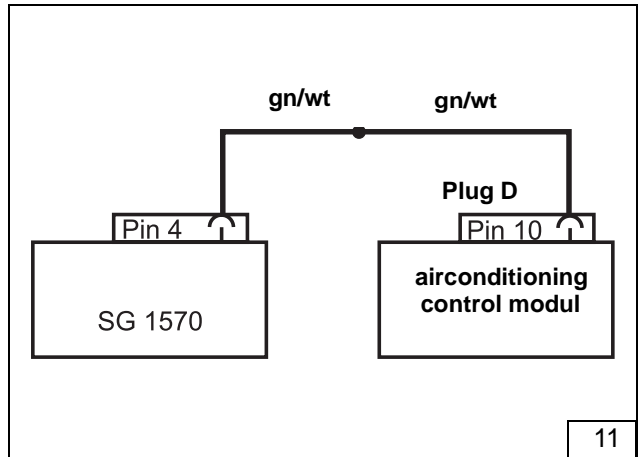
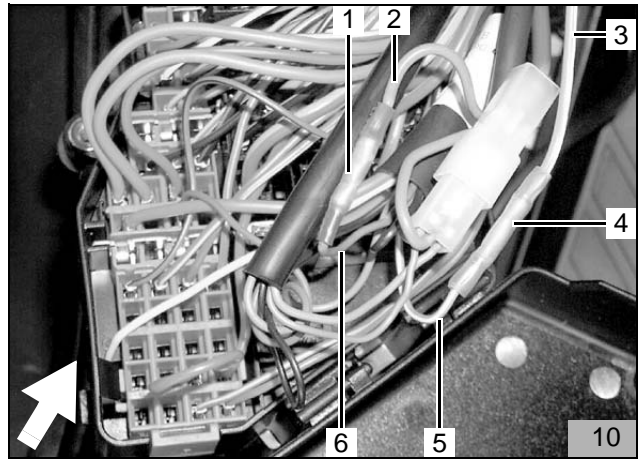

- Lay the gn/wt cable (12/1; 10/3) to the air-conditioning control module and crimp on the supplied microtimer
- Connect the gn/wt cable (12/1) to plug D (12/2) as shown in Figure 12 and Figure 11

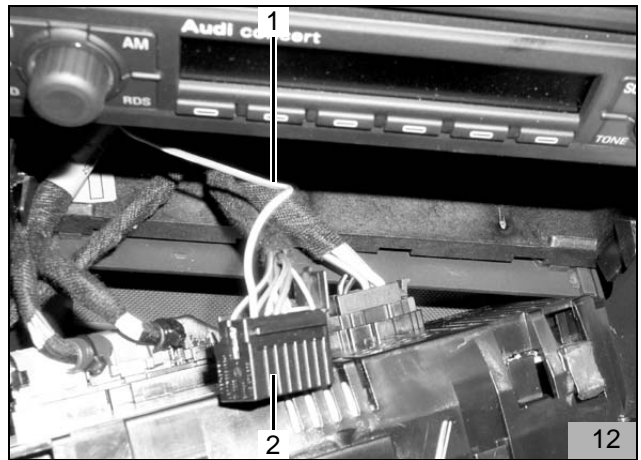

- Connect the br earth cables coming from the heater (13/1), going to the digital timer (13/5) (plug X9), coming from the digital timer wiring harness (13/6) and going to the dosing pump (13/4) to the br earth cable (13/2) 4.0 mm² using blade connectors (13/3)

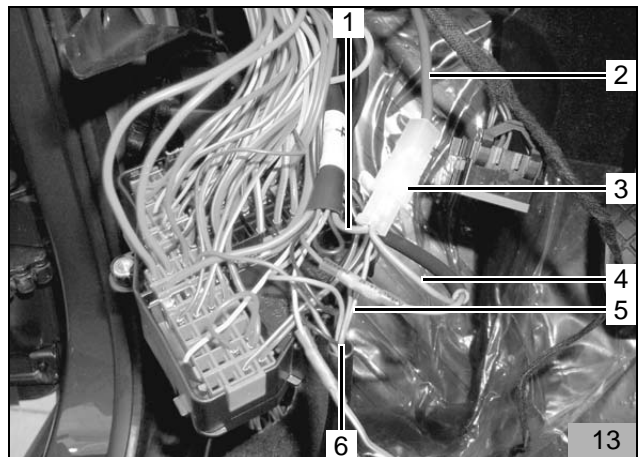

- Connect the br cable (14/1; 13/2) 4.0 mm² to the standard earth point (14/2) using the supplied 6 mm terminal lug

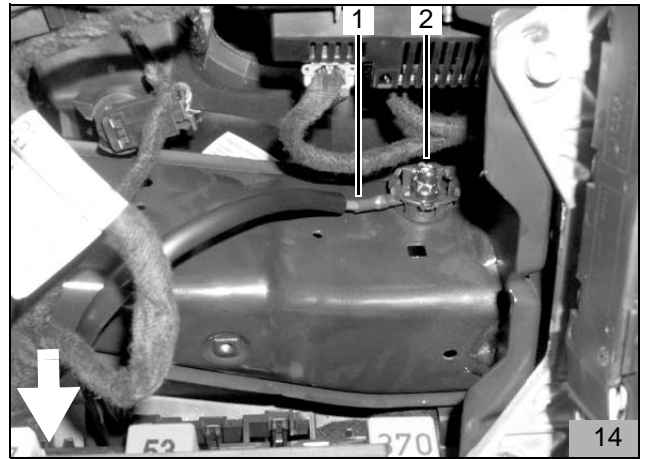

- Lay the supplied positive distributor (15/1,2) to the standard positive post (15/3) using a 6 mm terminal lug as shown in the Figure 15 and to the central electrical system

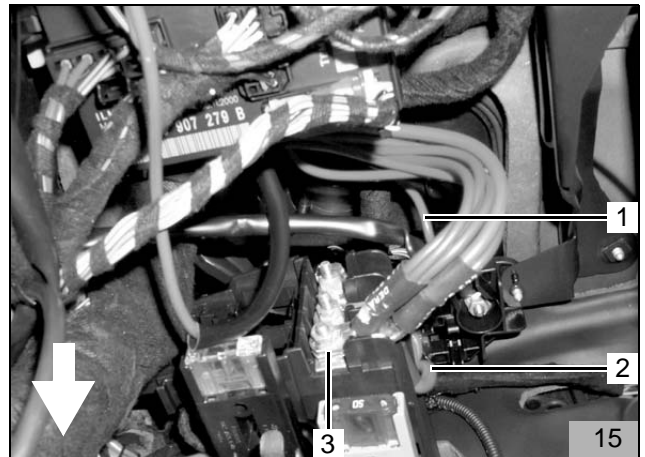

- Insert the positive cables (16/1,2,3) into the free fuse slots as shown in Figure 16
- Crimp the junior timer to the rd cable (16/4) 4.0 mm² from the heater
- Connect the rd cable (16/5) 4.0 mm² to the free fuse slot as shown in Figure 16
- Crimp the junior timer to the rd cable (16/4) 0.75 mm² from the digital timer
- Connect the rd cable (16/4) 0.75 mm² to the free fuse slot as shown in Figure 16

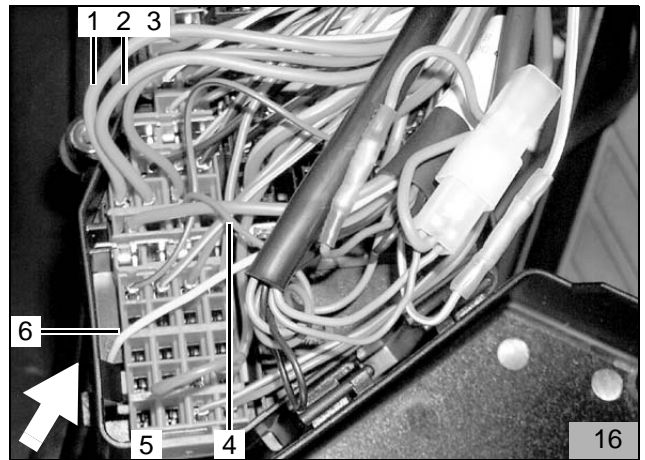

- Release and remove the plug connector (17/1) for the diagnostic cable (17/2)

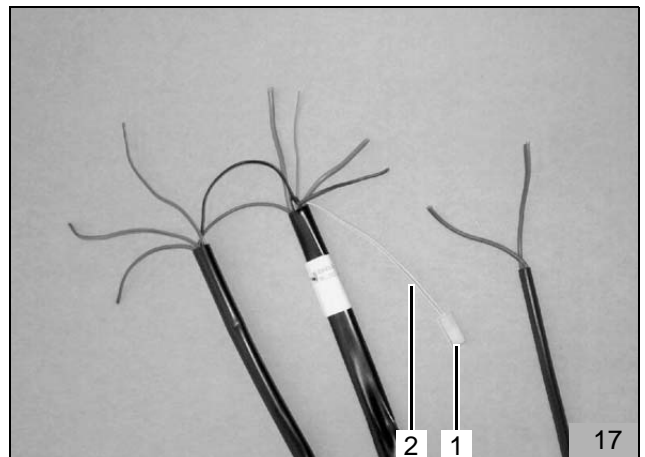

- Lay the diagnostic cable (18/2; 16/6) as shown in Figure 18 through the empty passage hole into the fuse holder
- Reconnect the plug connector (18/2) to the diagnostic cable
- Insert a 3 A fuse (18/3) (violet) for the digital timer as shown in Figure 18
- Insert a 20 A fuse (18/1) (yellow) for the heater as shown in Figure 18

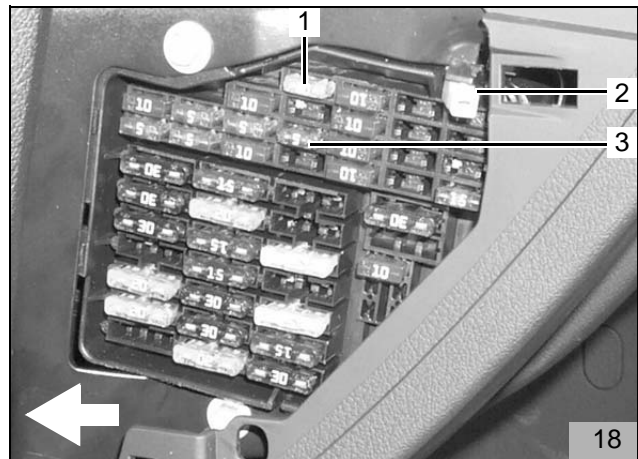

- Secure the wiring harnesses and cables with cable ties (19/1,2) as shown in Figure 19

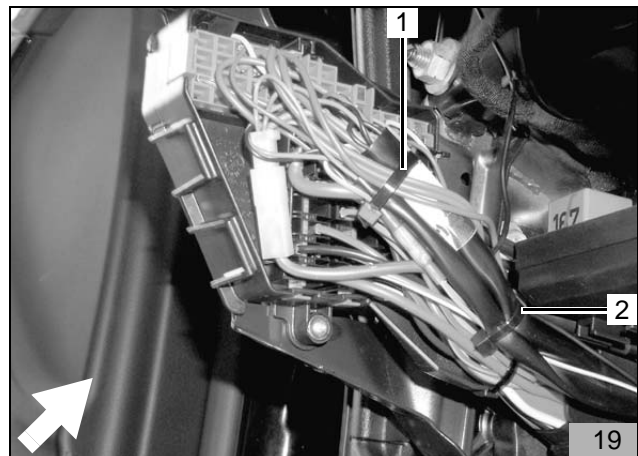

- Lay the digital timer wiring harness to the digital timer installation site
- Lay the dosing pump wiring harness (20/1) from the central electrical system to the standard wiring harness in the left door sills to the cable duct under the rear seat bench
- Lay the dosing pump wiring harness through the cable duct and then to the service flap on the tank fittings in the boot as shown in Figure 20

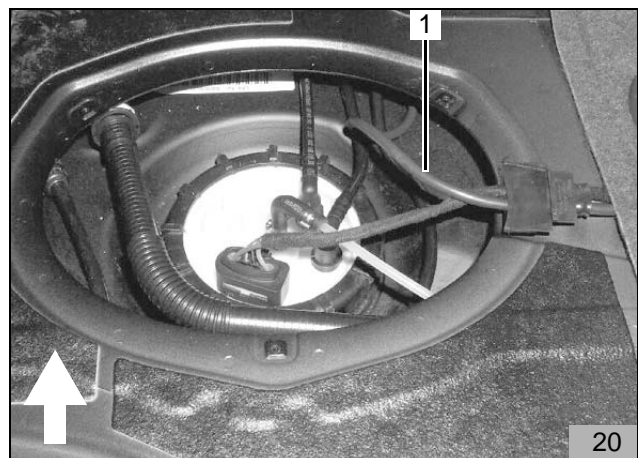

Digital timer and optional summer/winter switch

IMPORTANT

Do not press on the LCD display as you install the digital timer

NOTE:

The installation site for the digital timer (21/1) shown in the figure is only a recommendation. Before installation, please agree the installation site with your customer

- Affix the drilling template for the digital timer (21/1) in the required position
- Drill two holes using the template
- Remove the template
- Install the mounting sleeve using a self-tapping screw

NOTE:

Check the direction of the locking teeth (see installation manual). Fit a chafing guard when you install the wiring harness.

- Thread the digital timer wiring harness through the hole and connect the plug to the digital timer
- Connect the digital timer

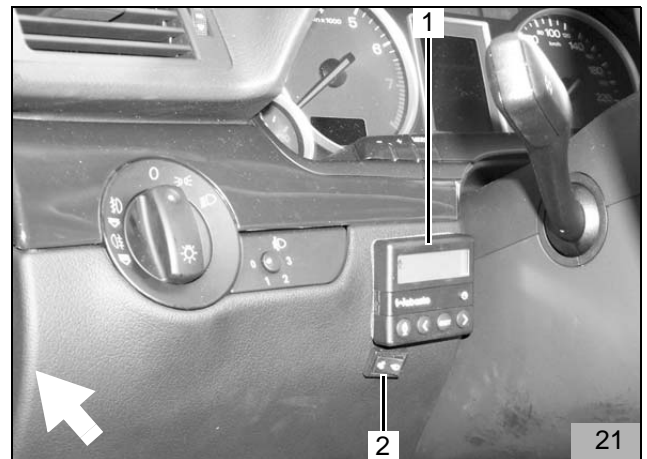

- Mark the holes for the summer/winter switch in the required position and drill the holes with a diameter of 12 mm
- Draw the nut and toothed washer over both cables
- Thread the brown and violet cables through the hole and connect them to the switch (bottom contacts) as shown in Figure 22
- Secure the summer/winter switch with a toothed washer and nut

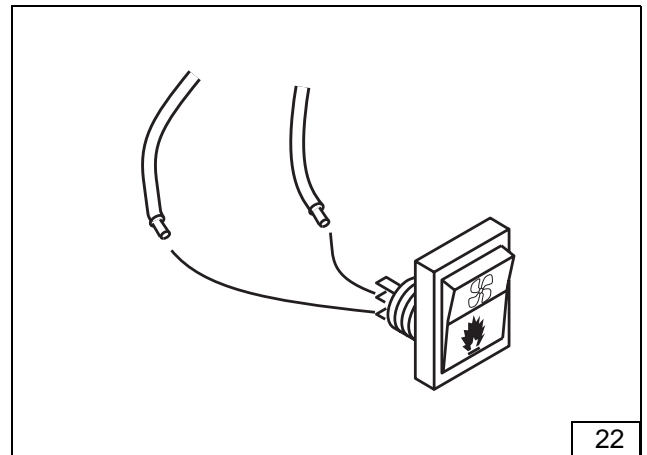

To install the heater

To prepare the installation site

- Remove the standard cable clip from position (23/2)
- Enlarge the existing hole (23/2) to a diameter of 9 mm as shown in Figure 23
- Insert a rivet nut M6 (23/2)
- Undo the standard screw M6 from position (23/1) (the screw will be reused)

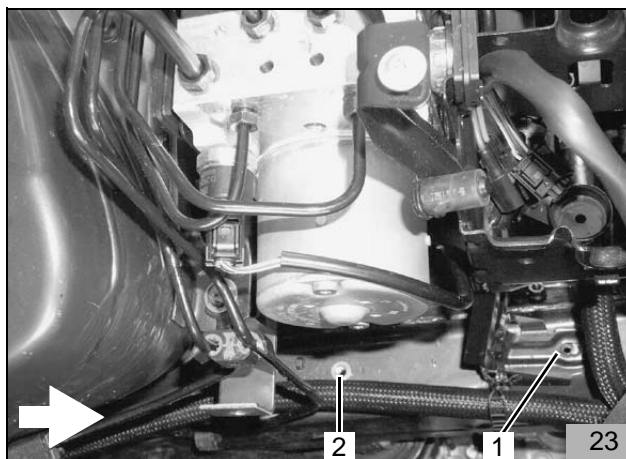

- Undo the standard screw M6 from position (24/1) (the screw will be reused)
- Secure the 30 mm spacer nut (24/2) with a screw M6x20 (24/1), spring ring A6 and body washer A7.4 to the existing threaded hole as shown in Figure 24
- Align the 30 mm retaining bracket (24/3) with a screw M6x12, spring ring A6 and body washer A7.4 as shown in Figure 24 and secure it to the spacer nut (24/2)

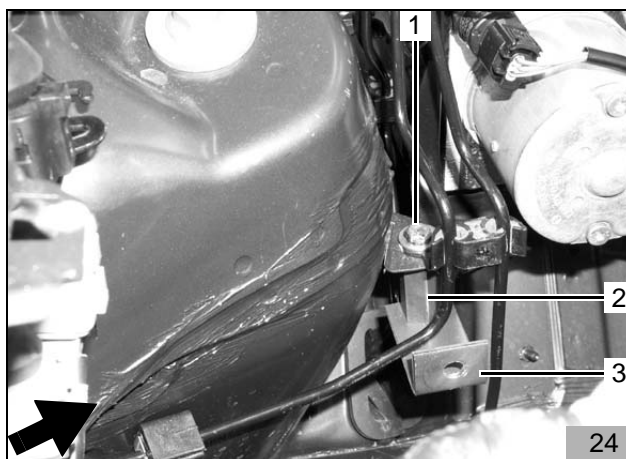

To pre-install the heater

IMPORTANT

Only use the special screws and special EJOT PT stud bolt supplied to secure the heater. (tightening torque 10 Nm)

NOTE:

Place a washer in position (25/3) and three washers in position (25/2) between the heater and the holder

- Screw the Ejot stud bolt (25/1) into the heater (25/2) (tightening torque 10 Nm)
- Secure the holder (25/4) to the heater (25/5) using two Ejot screws (25/2,3), placing a washer in position (25/3) and two washers in position (25/2) between the heater (25/5) and the holder (25/4) (tightening torque 10 Nm)

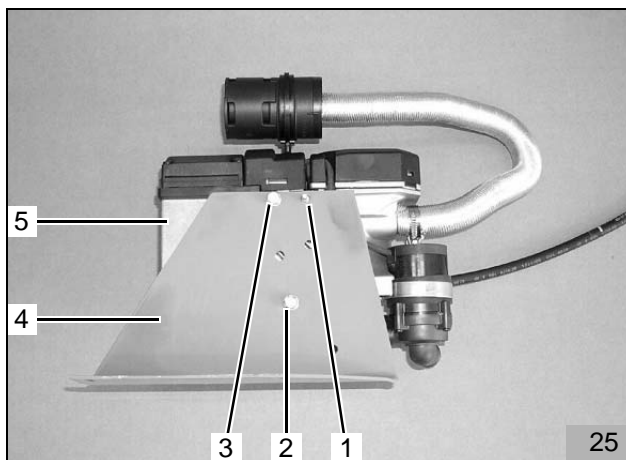

- Connect the supplied shaped hose (26/3) (internal diameter rising from 3.5 mm to 4.5 mm) to the heater (26/1) using the end with an internal diameter of 4.5 mm as shown in Figure 26 and secure it with a 10 mm Cailau clip (26/2)

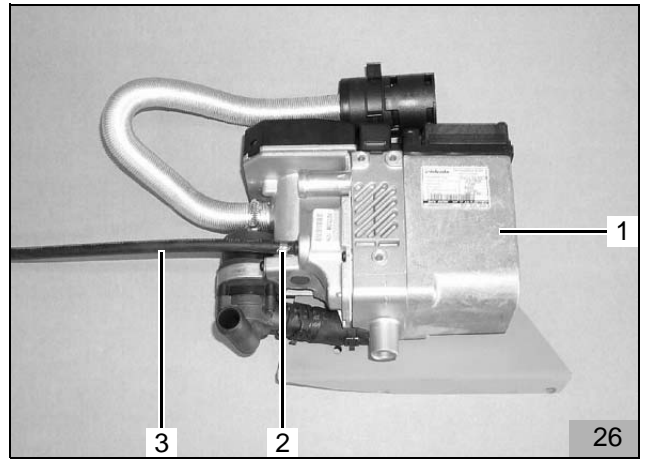

Combustion air intake line

NOTE:

Check the installation site of the air intake silencer, see "installation manual"

- Punch out the perforation in the heater cover and insert the clip (27/5) for the combustion air intake silencer as shown in Figure 27
- Connect the combustion air intake line (27/2) with the slotted side on the heater combustion air port and secure it with a hose clip (27/4)
- Lay the combustion air intake line as shown in Figure 27
- Screw the combustion air intake silencer (27/1) as far as possible into the combustion air intake line
- Insert the combustion air intake silencer into the retaining clip (27/5) as shown in Figure 27

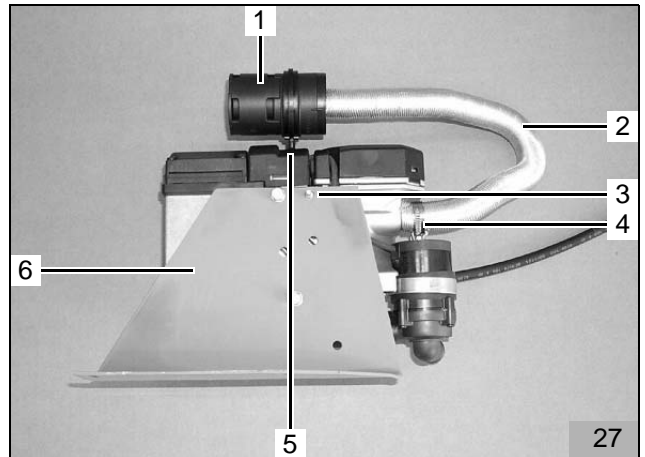

- Insert the pre-installed heater (28/1) as shown in Figure 28

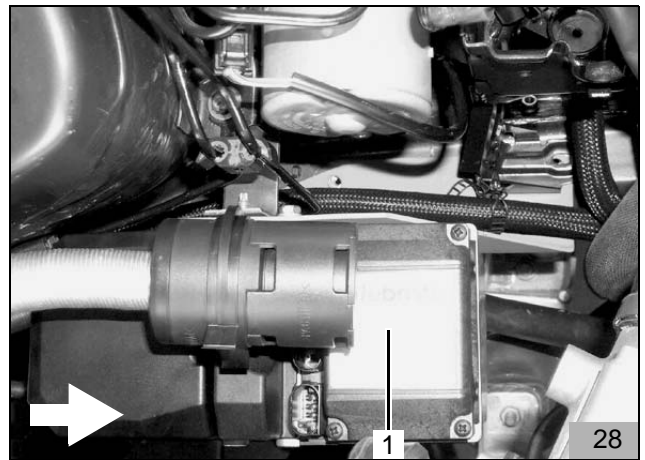

- Secure the Eجت stud bolt (29/6; 27/3) to the retaining bracket (29/4) as shown in Figure 29 with a flanged nut M6 (29/5)
- Secure the holder (29/2; 27/6) to the existing threaded hole using the standard screw M6 (29/3) as shown in Figure 9
- Secure the holder (29/2) using the standard screw M6 (29/1) as shown in Figure 29

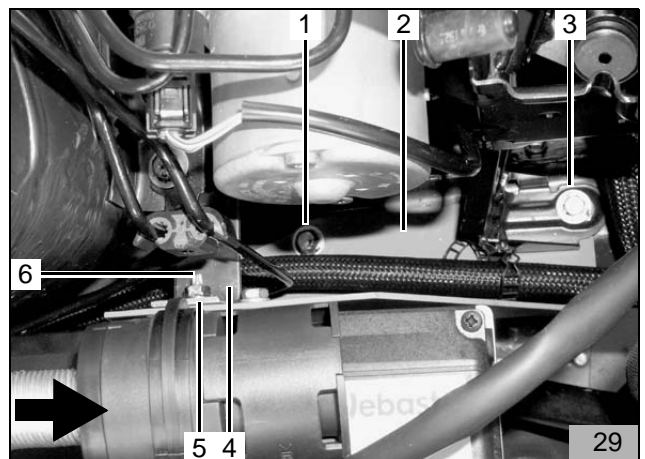

Integration in the water system

NOTE:

Catch escaping coolant water using a suitable container!
 Install the water hoses with no kinks!

The following describes how to integrate the heater into the car's coolant water system in an inline version (Figure 30)

Legend for Figure 30

- 1 Expansion tank
- 2 Radiator thermostat
- 3 Car engine
- 4 Circulating pump (heater)
- 5 Heater
- 6 Heating system heat exchanger (car)
- 7 Radiator

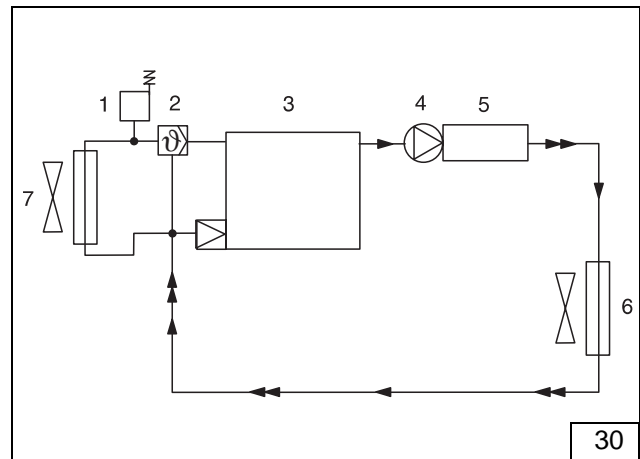

To prepare the water hoses

- Cut two lengths off the water hose supplied in the kit as shown in Figure 31:

1 x 390 mm (31/1)
 (from the standard water hose at the engine outlet to the heater water inlet)

1 x 330 mm (31/2)
 (from the heater water to the standard hose section to the heat exchanger)

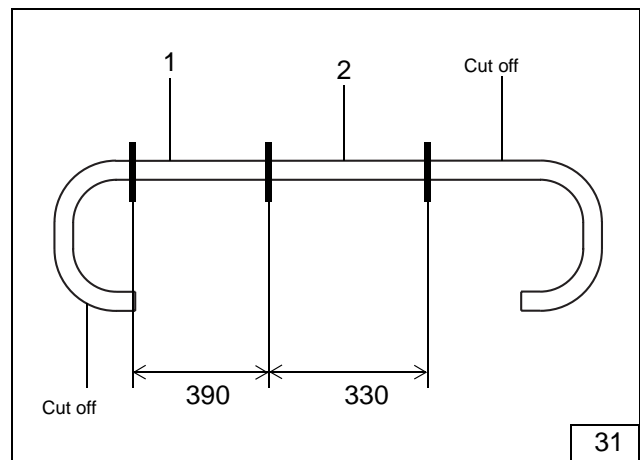

- Remove the standard water hose (32/1,2,3) from the engine outlet to the heat exchanger water inlet
- Cut the standard water hose (32/1,2,3) at the markings (arrows)

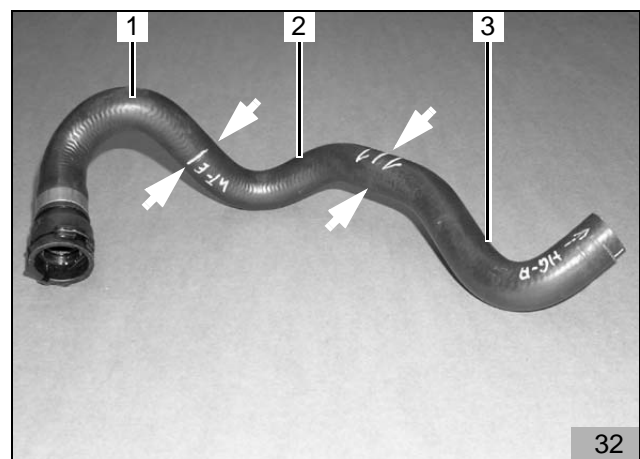

- Connect the standard hose section (33/2; 32/2) and the 330 mm water hose (33/5) as shown in Figure 33 using a connection pipe 20 x 20 and space-saving clips (33/3,4)
- Connect the standard hose section (33/10; 32/1) and the 390 mm water hose (33/6) as shown in Figure 33 using a connection pipe 20 x 20 and space-saving clips (33/8,9)

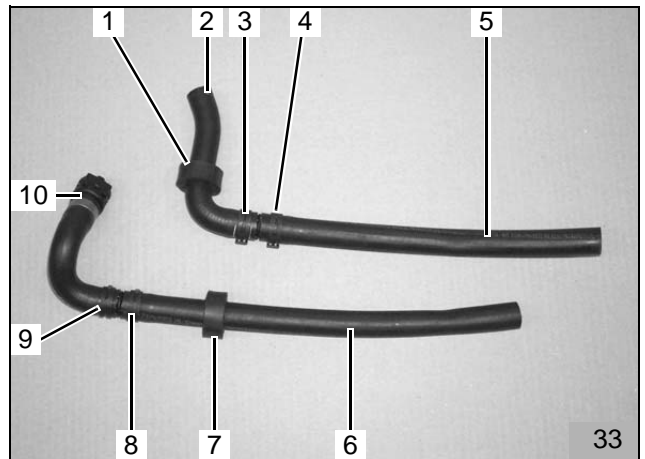

- Push the black rubber section (34/1; 33/1) on to the standard hose section (33/2) as shown in Figure 34 and Figure 33
- Push the black rubber section (34/4; 33/7) on to the 390 mm water hose (33/6) as shown in Figure 34 and Figure 33

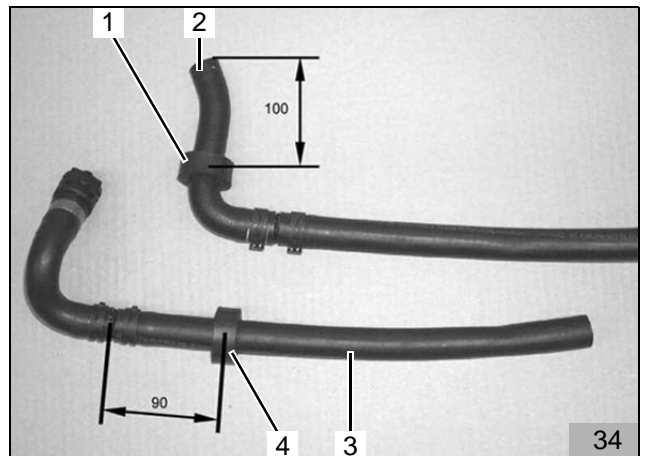

To install the water hoses

- Lay the prepared water hoses as shown in Figure 34 from the engine outlet to the heater water inlet and from the heat exchanger water inlet to the heater water outlet in the under-bonnet compartment
- Connect the pre-installed water hose (35/1,2; 33/6,10) from the engine outlet to the heater water inlet with a quick-release clip on the engine outlet, align it with the heater water inlet as shown in Figure 29 and secure it with a quick-release clip

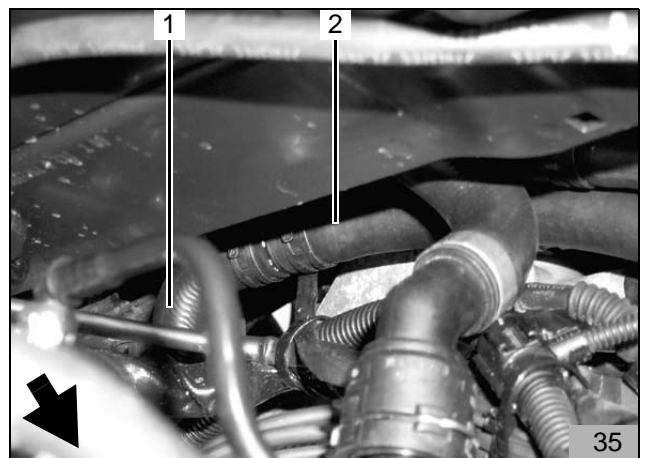

- Connect the 390 mm water hose (36/1; 35/2) as shown in Figure 36 to the heater water inlet and secure it with a spring strip clip (36/2)

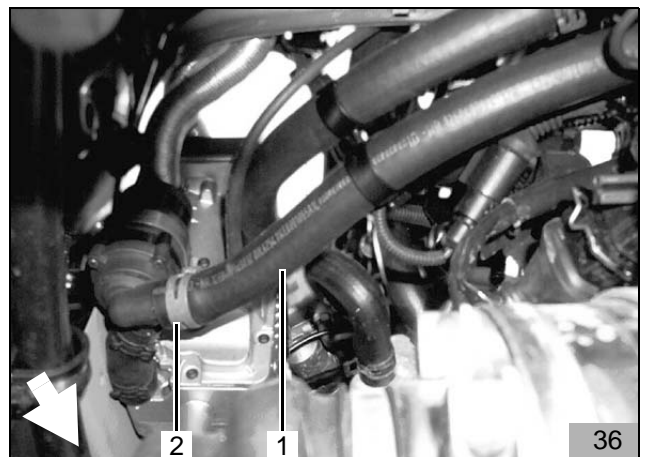

- Connect the standard hose section (37/3; 38/1) to the heat exchanger water inlet (37/1), align it as shown in Figure 37 and secure it using the standard spring strip clip (37/2)
- Lay the pre-installed water hose (37/5; 33/2,5) through the standard passage hole (37/6) in the radiator tank to the standard hose section (37/3)
- Connect the standard water hose (37/5) and the standard hose section (37/3) as shown in Figure 37 using a connection pipe 20 x 20 and spring strip clips (37/4)

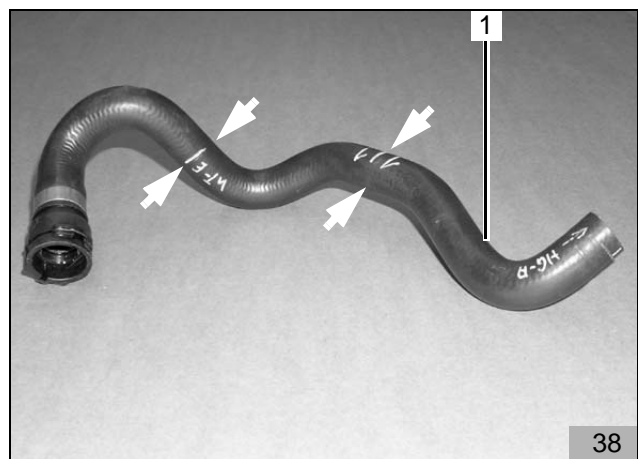
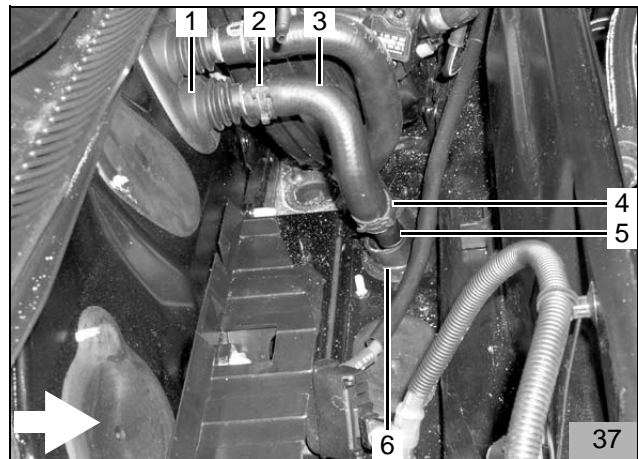

- Connect the 330 mm water hose (39/1; 33/5) to the heater water outlet and secure it with a spring strip clip (36/2) as shown in Figure 39

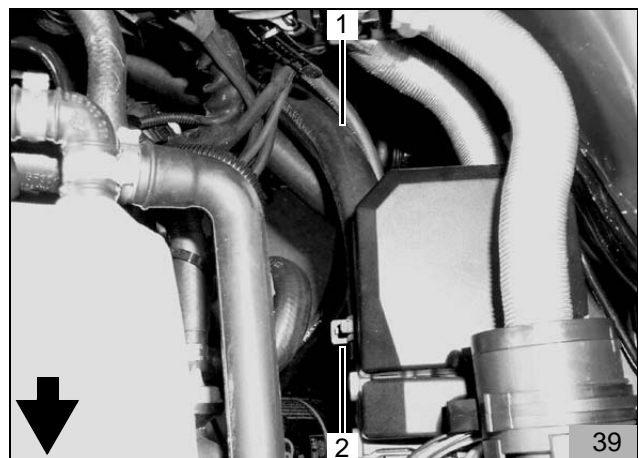

- Position the black rubber section (40/1; 34/4) as shown in Figure 40
- Position the black rubber section (34/1) under the radiator tank on the bulkhead

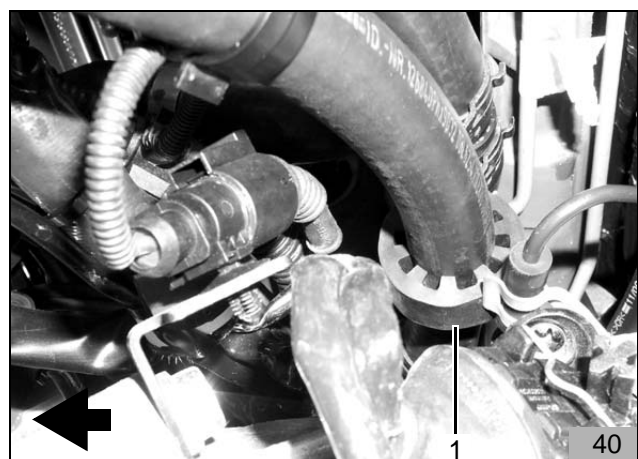

- Insert the supplied spacer (41/3) between the 330 mm water hose (41/1) and the 390 mm water hose (41/2) as shown in Figure 41

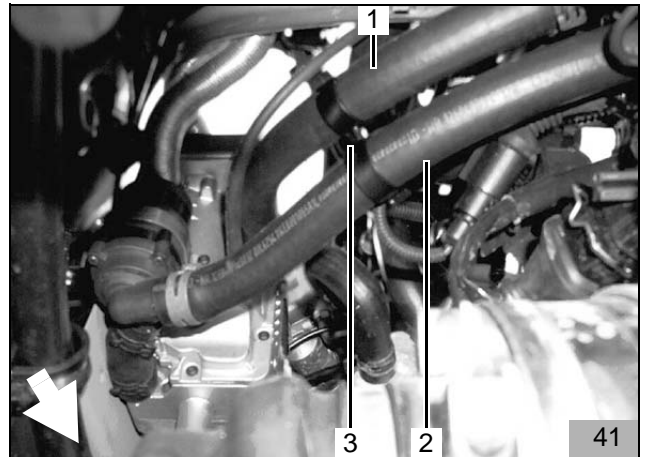

Integration in the fuel system

IMPORTANT

Open the filler cap, release the pressure from the fuel tank system and close the filler cap again!

Lay the fuel lines so that they are protected from stones and heat!

Fit a chafing guard on the fuel lines around sharp edges!

Install the fuel lines with no kinks!

Dosing pump

NOTE:

Check the installation site of the dosing pump, see "installation manual"

- Secure the bracket (42/5) to the existing screw M8 (42/1) as shown in Figure 42
- Secure the dosing pump (42/3) to the bracket (42/5) using an anti-vibration mount (42/2), rubberised pipe clip (42/4) and flanged nuts as shown in Figure 42

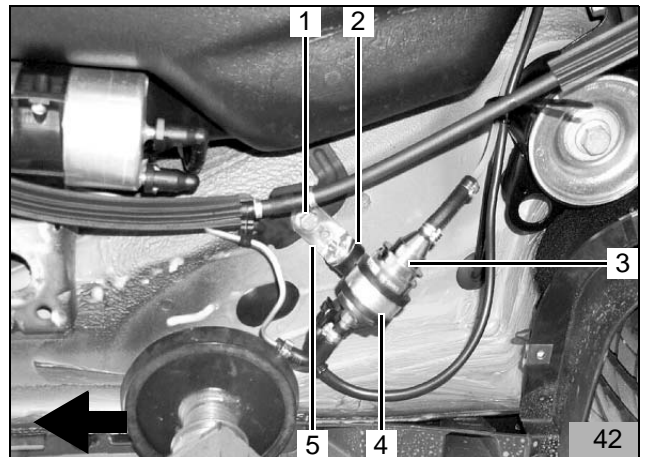

- Connect the supplied 90° shaped hose (43/3) (internal diameter rising from 3.5 mm to 4.5 mm) to the outfeed from the dosing pump (43/1) (side with the plug) using the end with an internal diameter of 4.5 mm
- Align the 90° shaped hose (43/3) as shown in Figure 43 and secure it to the dosing pump using a 10 mm Cailau clip
- Insert the metal fuel line (43/4) into the end of the 90° shaped hose (43/3) with an internal diameter of 3.5 mm and secure it with an 8 mm Cailau clip
- Lay the dosing pump wiring harness (43/2) to the dosing pump and cut it to length
- Push a rubber grommet on to the dosing pump wiring harness, crimp on a blade terminal, complete the plug casing and connect the wiring harness to the dosing pump as shown in Figure 43

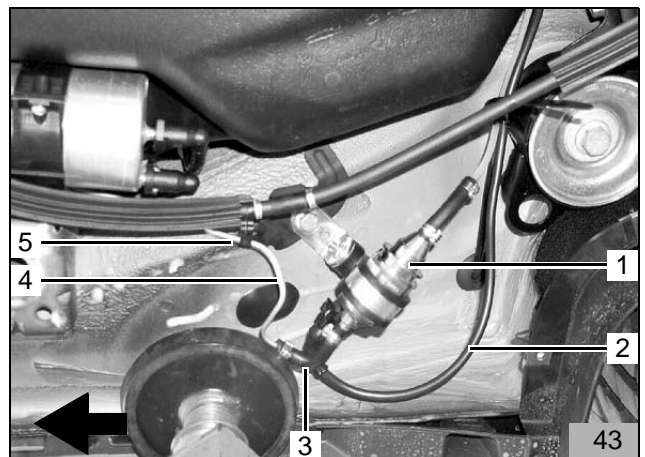

To install the metal fuel line

- Lay the metal fuel line from the dosing pump to the heater as shown in Figure 43 to Figure 50
- Cut the supplied 80 mm plastic hose into eight equal sections of 10 mm, push them on to the metal fuel line and position them level with the standard holders for the fuel line
- Open the holder (44/2,4,5,6) for the standard fuel line and insert the metal fuel line (44/3) with the attached plastic hoses
- Close the holders (44/2,4,5,6) again
- Secure the metal fuel line to the standard fuel line using the clips supplied (43/5; 44/1)

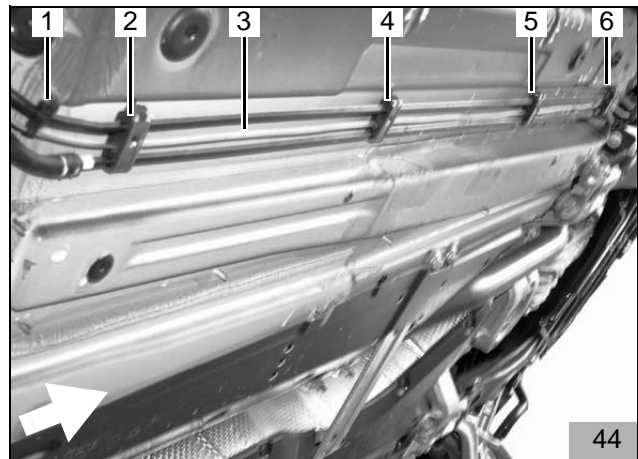

- Secure the metal fuel line (45/2,4) to the standard fuel line using the clips supplied (45/1,3,5,6)

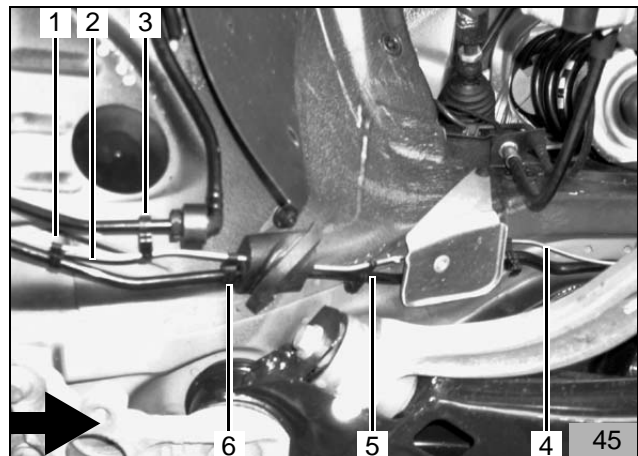

- Secure the metal fuel line (46/2,3) to the standard fuel line using the clip supplied (46/1)

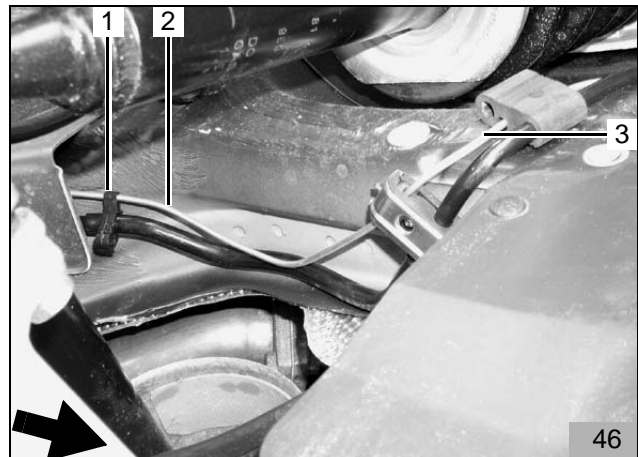

- Open the holder (47/5) for the standard fuel line and insert the metal fuel line (47/1,6) with the attached plastic hoses
- Close the holder (47/5) again
- Insert the supplied guide rubber (47/4) as shown in Figure 45
- Lay the metal fuel line (45/1,6) through the standard passage into the under-bonnet compartment
- Secure the metal fuel line (47/1,6) to the standard fuel line using the clip supplied (47/3)

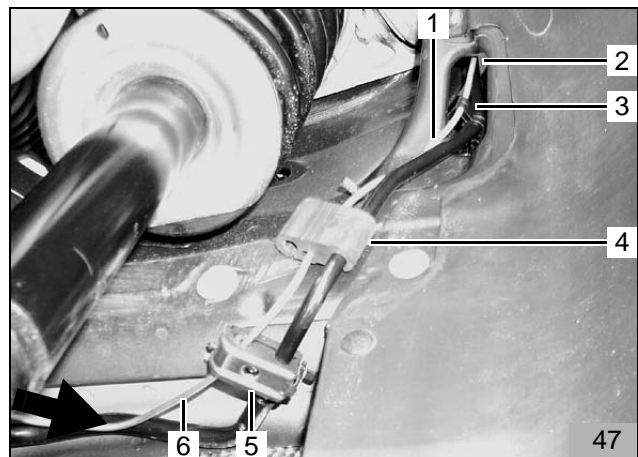

- Open the holder (48/3) for the standard fuel line and insert the metal fuel line (48/1) with the attached plastic hoses
- Close the holder (48/3) again
- Secure the metal fuel line (48/1) to the standard fuel line using the clip supplied (48/2)

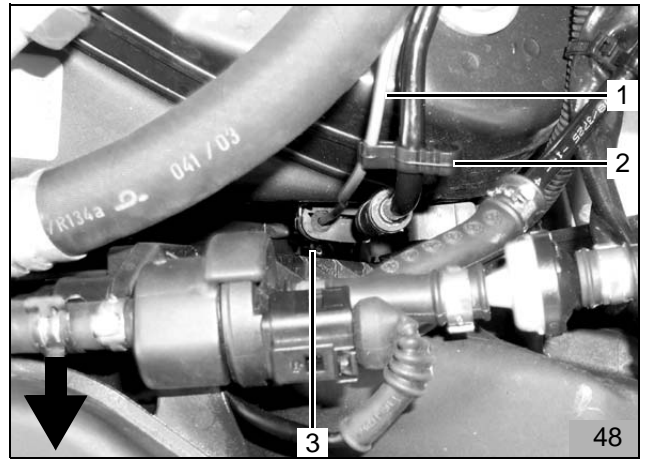

- Open the holders (49/3,4) for the standard fuel line and insert the metal fuel line (49/1,2) with the attached plastic hoses
- Close the holders (49/3,4) again
- Secure the metal fuel line (49/2,3) to the standard fuel line using the clip supplied (49/1)
- Secure the metal fuel line (49/1,2) to the standard fuel line using the clip supplied (49/5)

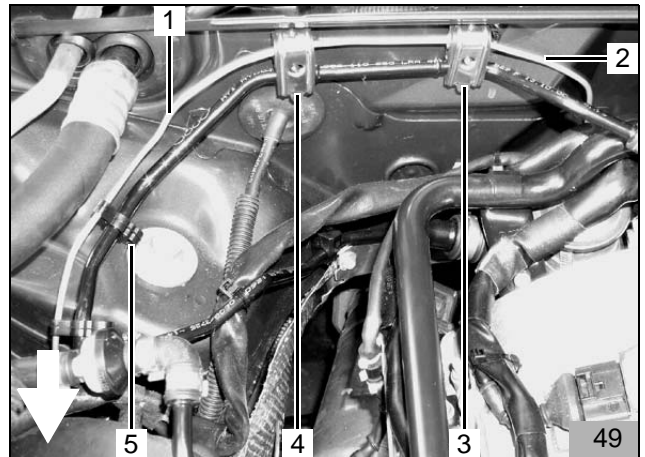

- Insert the metal fuel line (50/5) into the end of the shaped hose with an internal diameter of 3.5 mm (50/3) and secure it with an 8 mm Cailau clip (50/4)
- Secure the metal fuel line (50/5) to the standard fuel line using the clips supplied (50/1,2)
- Secure the metal fuel line to the standard fuel line after the fuel filter using the remaining clip

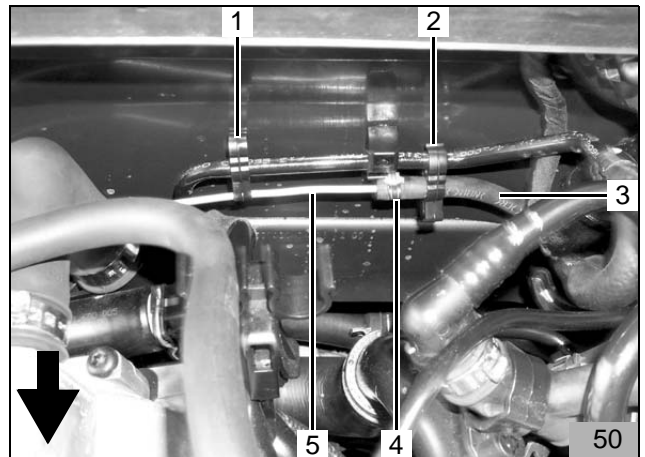

Fuel extraction

The fuel is extracted using the tank extracting device from the tank fittings

- Cut the supplied tank extracting device (51/1) to length as shown in Figure 51
- Cut the supplied fuel hose (51/2) to length as shown in Figure 51 (150 mm extended length)
- Cut the supplied riser pipe (51/3) to length as shown in Figure 51

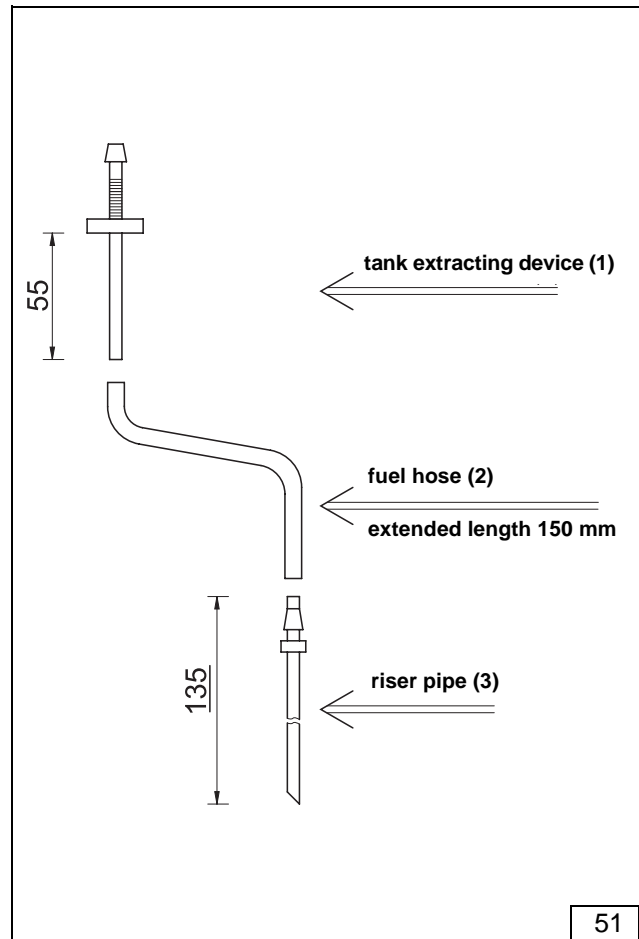

IMPORTANT

Open the car's filler cap, vent the tank and close the filler cap again!

Catch escaping fuel using a suitable container!

- Remove the tank fittings (52/1) following the manufacturer's instructions
- Drill a 6.0 mm hole in position (52/2) in the tank fittings

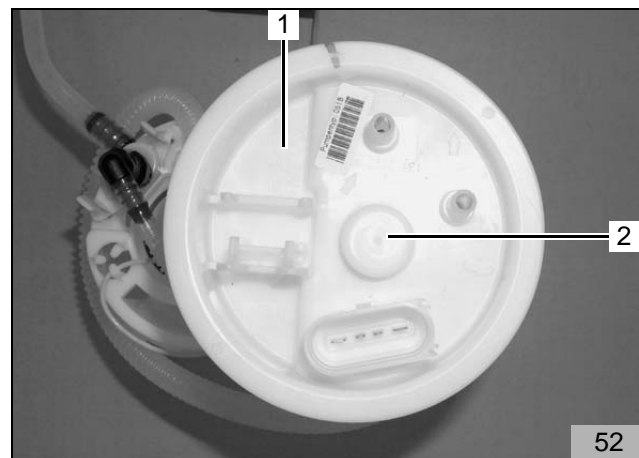

- Secure the tank extracting device (53/6; 54/6) in the tank fittings (53/1; 54/1) as described in the supplied installation manual
- Push the fuel hose (53/4; 54/4) on to the tank extracting device as shown in Figure 53 and Figure 54
- Secure the fuel hose using the supplied 6.6 mm hose clip (53/5; 54/3) as shown in Figure 53 and Figure 54

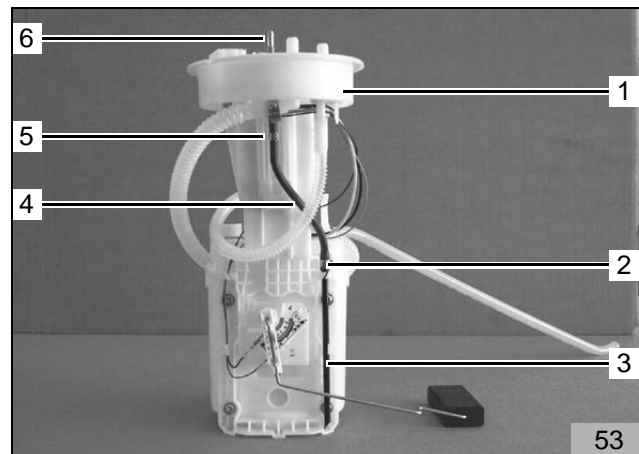

- Insert the riser pipe (54/3; 53/3) into the tank fittings as shown in Figure 54 and Figure 53
- Push the fuel hose (54/4; 53/4) on to the riser pipe
- Secure the fuel hose using the supplied 8.0 mm hose clip (54/2; 53/2) as shown in Figure 54 and Figure 53

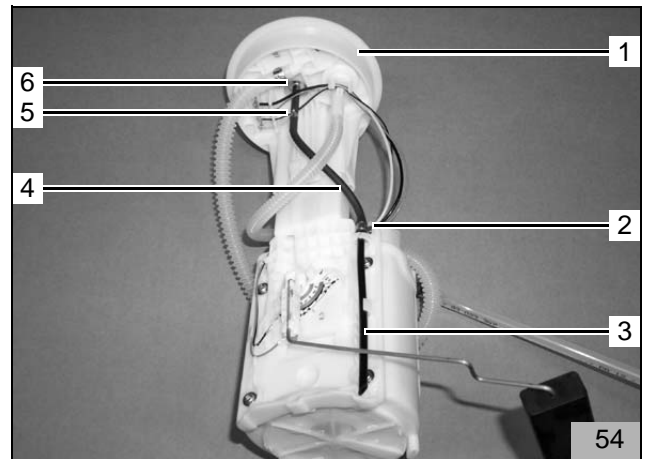

- Connect the supplied 90° shaped hose (55/1) (internal diameter rising from 3.5 mm to 4.5 mm) to the tank extracting device (55/3) using the end with an internal diameter of 3.5 mm
- Secure the 90° shaped hose using the supplied 9 mm Cailau clip (55/2) as shown in Figure 55
- Install the tank fittings again as described by the manufacturer

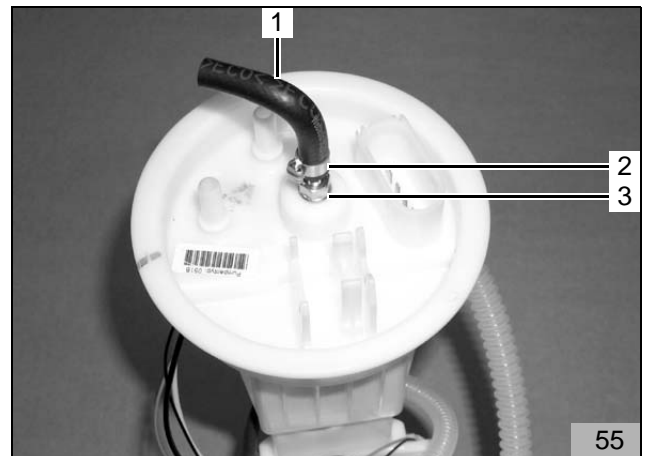

- Insert the Mecanyl fuel line (66/3) into the 90° shaped hose (66/1; 65/1) and secure it with a 10 mm Cailau clip as shown in Figure 66

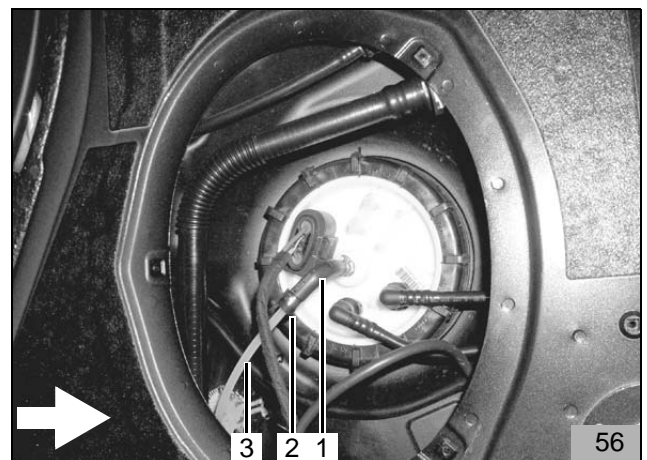

- Lay the Mecanyl fuel line (57/1; 56/3) to the intake side of the dosing pump (57/3) and cut it to length
- Connect the Mecanyl fuel line (57/1) as shown in Figure 57 with the hose section (57/2) 10 mm Cailau clips
- Secure all cables and wiring harnesses with cable ties

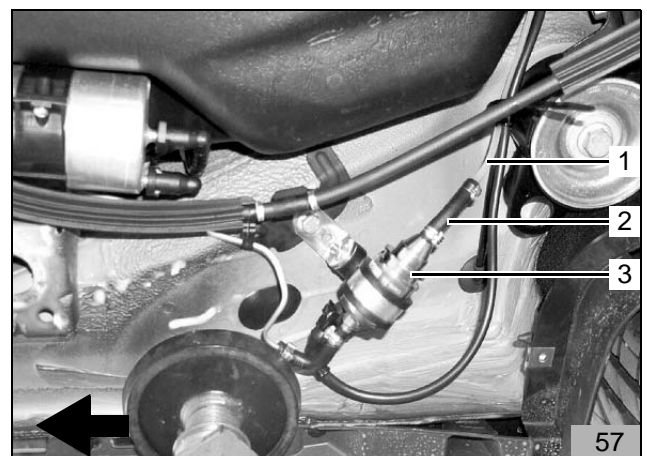

Exhaust system

IMPORTANT

Ensure that you leave sufficient space to hoses and cables when you install the exhaust system!

- Secure the servo hose (58/1) to the standard stud bolt using a 25 mm rubberised pipe clip (58/3) and a plastic nut (58/2) as shown in Figure 58

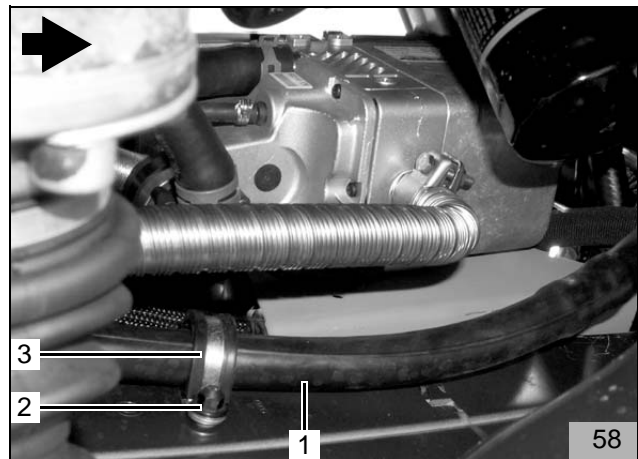

- Cut the exhaust pipe and exhaust pipe end piece as shown in Figure 59

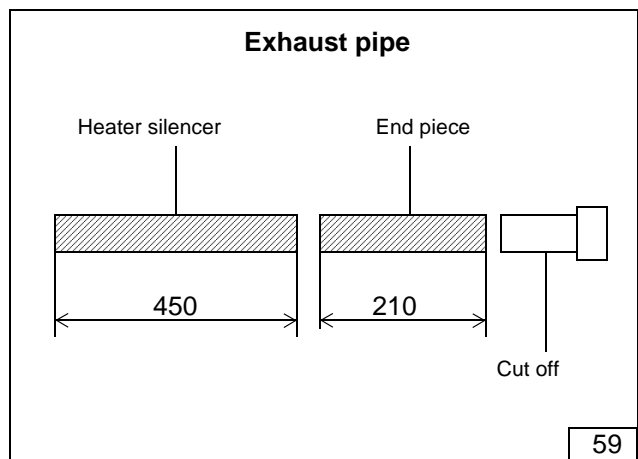

- Secure the supplied bracket (60/2) using the standard screw (60/1) as shown in Figure 60

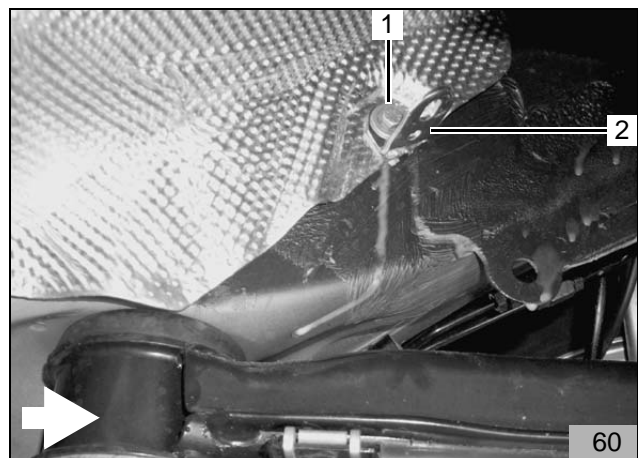

- Secure the exhaust silencer (61/1) to the bracket (61/3; 60/2) using the screw M6x20 (61/2) and flanged nut M6 as shown in Figure 61

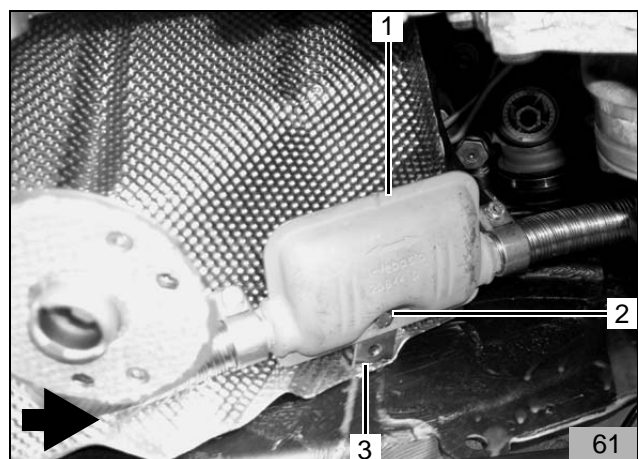

- Connect the 450 mm exhaust pipe (62/2) to the heater and secure it with a hose clip as shown in Figure 62

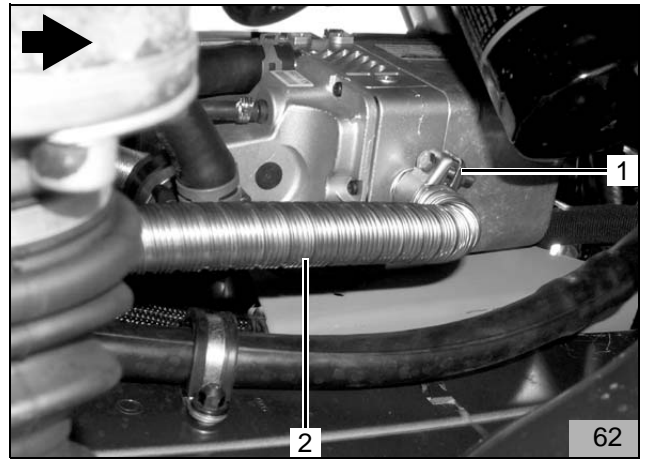

- Shape the 450 mm exhaust pipe (63/3; 62/2) as shown in Figure 63 and Figure 62, connect it to the exhaust silencer (63/1) and secure it with a hose clip (63/2)
- Connect the 210 mm exhaust pipe (63/5) to the exhaust silencer (63/1) heater and secure it with a hose clip (63/4)
- Connect the exhaust passage (63/6) to the 210 mm exhaust pipe (63/5) and secure it with a hose clip

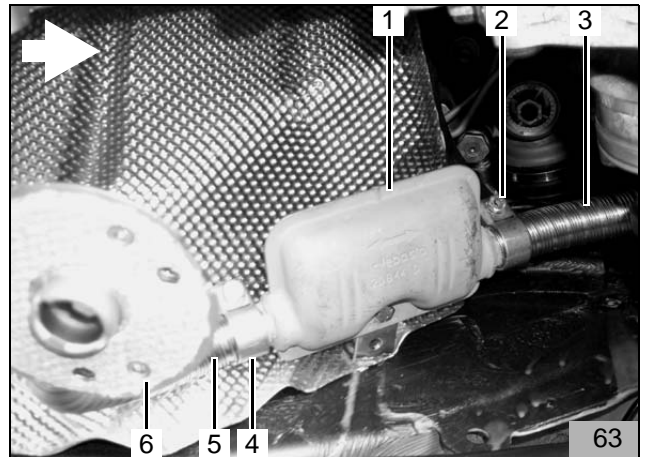

Exhaust passage

- Place the supplied template on the underride guard as shown in Figure 64 and mark the holes (64/1,2,3,5) on the underride guard
- Drill three 5.0 mm holes (64/1,2,5) as shown in Figure 64
- Drill 27 mm holes (64/3)
- Install the underride guard
- Secure the exhaust passage (63/6) to the underride guard using three screws M5x20 and body washers

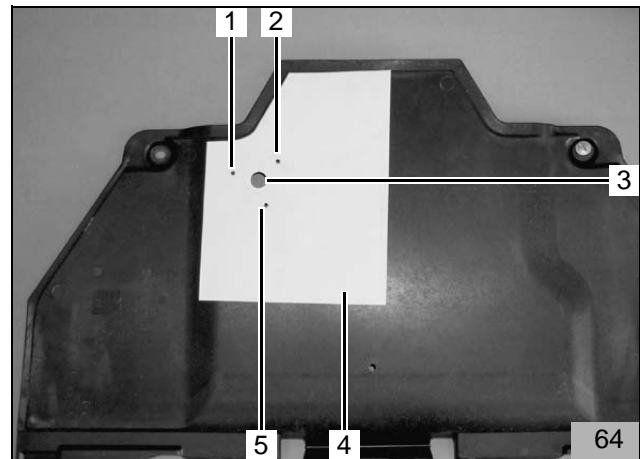

Concluding work

- Install and connect the battery
- Install all the removed parts in reverse
- Check that all hose lines, hose and pipe clips and all electrical connections are secure
- Secure all loose lines and cables with cable ties
- Take all tools, such as clamping claws, etc. out of the under-bonnet compartment
- Spray the heater components with anti-corrosive wax (Tectyl ML, order No. 111329)

IMPORTANT

Only use genuine Audi coolant!

- Start the engine, bleed the water system as described in the repair guidelines, top up the coolant
- Set the car's heating system to "DEF" and the blower to II **with the ignition switched on**
- Switch on the Webasto heating system, see "operating manual/installation manual"

Operating instructions for the end customer

NOTE:

Please cut out and hand this page to the end customer!

IMPORTANT

This car is fitted with a Webasto additional heating system!

The installation site of the heater mean that access to the oil filter is more difficult!

Additional heating system fuse assignment

- Heating system fuse (65/1)
20 A (yellow)
- Digital timer fuse (65/3)
3 A (violet)
- Webasto diagnostic plug (65/2)

To operate the additional heating system

- Set the car's heating system to "DEF", the blower to II and the temperature to max. 28°C **with the ignition switched on**

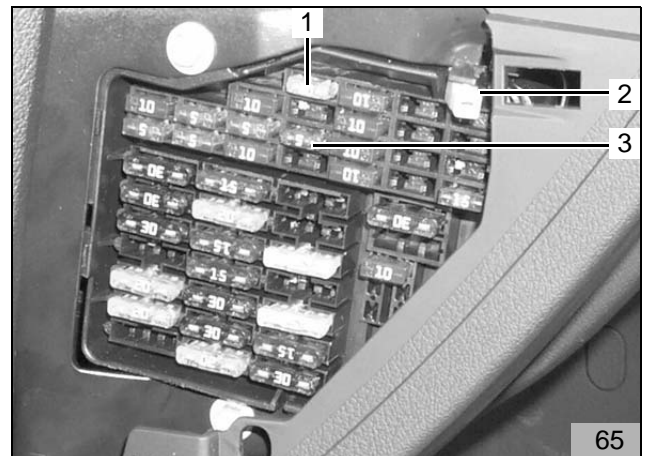



Feel the drive

Webasto Thermosysteme International GmbH
Postfach 80 - D-82132 Stockdorf - Hotline 0 18 05 / 93 22 78
Hotfax (0395) 55 92-353 - <http://www.webasto.de>

Audi A4

1,8l Turbo

1,9l TDI

